

# *can-am*®



## **SIDE-BY-SIDE PRODUCT SPEC BOOK**

**VEHICLE SPECIFICATIONS, ACCESSORIES,  
PARTS & MAINTENANCE AND APPAREL**

**2026**

# TABLE OF CONTENTS

<b>CAN-AM DEFENDER</b>	<b>5</b>
<b>CAN-AM MAVERICK R</b>	<b>79</b>
<b>CAN-AM MAVERICK X3</b>	<b>111</b>
<b>CAN-AM COMMANDER, MAVERICK TRAIL &amp; MAVERICK SPORT</b>	<b>161</b>
<b>PARTS AND MAINTENANCE</b>	<b>211</b>
<b>CAN-AM APPAREL</b>	<b>239</b>

---

Pricing is subject to change due to various taxes, tariffs, or duties which may be applicable on certain products. BRP reserves the right to change the prices without incurring any obligations.

---

**CANAMOFFROAD.COM**

© 2025 Bombardier Recreational Products Inc. (BRP). All rights reserved. ®, TM and the BRP logo are trademarks of BRP or its affiliates. In the USA, products are distributed by BRP US Inc. All other trademarks are the property of their respective owners. BRP reserves the right to discontinue or change specifications, prices, designs, features, models or equipment without incurring obligation. Some models shown may include optional equipment. Product performance may vary depending on external factors. BRP recommends that all SxS drivers take a training course. See your dealer. SxS can be hazardous to operate. Never exceed the SxS's passenger capacity. All SxS models are meant to be used by drivers aged 16 and older. Read the operator's guide. Follow all instructional and safety material and observe applicable laws and regulations. SxS are for off-road use only; never ride on paved surfaces or public roads. For your safety, the operator and passenger(s) must wear a helmet, eye protection and applicable protective clothing. Always remember that riding and alcohol/drugs don't mix. Never engage in stunt driving. Avoid excessive speed and be particularly careful on difficult terrain. Always ride responsibly and safely. See your authorized BRP dealer for details and visit <https://can-am.brp.com/>. Printed in Canada.



# IF WE SELL IT, WE STAND BY IT.

---

## **BRP Limited Warranty\*** for new Parts, Accessories and Riding Gear

---

### **1-year limited warranty\*\***

- Genuine BRP Parts and Accessories installed by you or your authorized BRP dealer
- Aftermarket Products sold through BRP
- Riding Gear

### **4-year limited warranty\*\***

- Helmets

**GET ALL THE DETAILS FROM  
YOUR CAN-AM OFF-ROAD DEALER**

\* Purchased at an authorized BRP dealership/distributor or on a BRP-authorized online store. Other exclusions may apply; see complete limited warranty or contact your Can-Am Off-Road authorized dealer. This limited warranty does not apply to factory-installed accessories and Evinrude parts and accessories.

\*\* Unless otherwise stipulated or required by law.



# CUSTOMIZING MADE EASY

- 1 SELECT THE MODEL.**
- 2 SELECT THE PACKAGE.**
- 3 CUSTOMIZE COLOR, ENGINE,  
AND ACCESSORIES  
(OR ACCESSORY BUNDLES)  
FOR YOUR VEHICLE.**
- 4 CLICK “SAVE”  
OR “SEND TO DEALER.”**

## BUILD YOURS NOW

If you can dream it, you can build it. And ride it. Creating a Can-Am vehicle tailor-made for our riders' needs has never been easier. Scan the QR code and follow the step-by-step.



# CAN-AM DEFENDER



# CAN-AM DEFENDER

## COMPARATIVE CHART 8

## ACCESSORIES 21

Roofs	22
Cabs	23
Windshields & Mirrors	25
Rear Wind Protection	28
Doors	29
Seat Accessories	32
Aluminum Skid Plates	33
Bumpers & Guards	34
LinQ: Easy On, Easy Off Cargo	38
Cargo & Storage	44
Racks & Holders	48
ACM & SMART Accessories	52
Lights	54
Audio & Communication Systems	60
Electronic Accessories	62
Winches & Hitches	66
Performance	68
Apache Track Systems	70
ProMount Plows	73
Covers & Add-Ons	78

G2: 2026 Defender HD11

G1: 2026 Defender HD7, HD9, HD10  
& Prior Defender





DEFENDER

Can-Am



**DEFENDER\*\*\***

COLOR OPTIONS		Compass Green	
ENGINES	Type	HD7 52 hp / 42 lb-ft, Rotax® ACE (Advanced Combustion Efficiency) 650 cc single cylinder, liquid-cooled	HD9 65 hp / 59 lb-ft, Rotax® 976 cc, V-twin, liquid-cooled
	Fuel Delivery System	Intelligent Throttle Control (iTC™) with Electronic Fuel Injection (EFI)	
	Transmission	pDrive primary CVT with engine braking and Electronic Drive Belt Protection L / H / N / R / P	PRO-TORQ CVT with Quick Response System (QRS), high airflow ventilation and Electronic Drive Belt Protection Extra-L / H / N / R / P
	Drive Train	Selectable Turf Mode / 2WD / 4WD with Visco-Lok† auto-locking front differential	
	Driving Assistance	CVT engine braking ECO™ / ECO™ Off / Work modes Speed limiter	
	Power Steering	N/A	
	SUSPENSIONS	Front Suspension	Double A-arm / 10 in. (25.4 cm) suspension travel
Front Shocks		Twin-tube gas charged shocks	
Rear Suspension		TTA with external sway bar / 10 in. (25.4 cm) suspension travel	
Rear Shocks		Twin-tube gas charged shocks	
TIRES/ WHEELS	Front/Rear Tires Wheels XPS Trail Force 27 x 9/11 x 14 in. 14 in. cast-aluminum		
BRAKES	Front	Dual 220 mm disc brakes with hydraulic twin-piston calipers	
	Rear	Dual 220 mm disc brakes with hydraulic single-piston calipers	
	Brake Holding Mechanism	N/A	
DIMENSIONS / CAPACITIES	Cage	Profiled cage ROPS approved	
	Estimated Dry Weight	1,482 lb (672 kg)	1,505 lb (683 kg)
	L x W x H	121 x 62 x 76 in. (307.1 x 157.5 x 193 cm)	
	Wheelbase	83 in. (211.5 cm)	
	Ground Clearance	11 in. (28 cm)	
	Cargo Box Dimensions	38 x 54.5 x 12 in. (96.5 x 138.4 x 30.5 cm)	
	Cargo Box Capacity	1,000 lb (454 kg) / California only: 600 lb (272.2 kg)	
	Power Tilt Bed	N/A	
	Tailgate Load Capacity	250 lb (113.4 kg)	
	Storage Capacity	Total: 3.1 gal (11.7 L)	
	Towing Capacity	2,500 lb (1,134 kg)	
	Payload Capacity	1,500 lb (680 kg)	
	Fuel Capacity	10.6 gal (40 L)	
Person Capacity	3		
FEATURES	Gauge	4.5 in. wide digital display	
	Battery	12 V (18 amp/h)	
	Magneto	650 W	
	Instrumentation	DC outlet (10 A)	
	Lighting	Front lighting output 140 W LED taillights	
	Winch	N/A	
	Seat	VERSA-PRO bench seat with passenger's seats flipping up Underside hooks	
	Steering Wheel	Tilt steering adjustment	
	Protection	Integrated front steel bumper Full heavy-duty HMW plastic skid plate	
	Hitch Type	2 in. hitch receiver	

†Visco-Lok is a trademark of GKN Viscodrive GmbH.

\*Smart-Lok was developed in conjunction with TEAM Industries, a market leader in the drive train industry.

\*\*\*1-year BRP limited warranty. B.E.S.T. term available up to 30 months.





**DEFENDER DPS\*\*\***

COLOR OPTIONS		Compass Green Dark Wildland Camo	Compass Green Stealth Black Dark Wildland Camo	Compass Green
ENGINES	Type	HD7 52 hp / 42 lb-ft, Rotax® ACE (Advanced Combustion Efficiency) 650 cc single cylinder, liquid-cooled	HD9 65 hp / 59 lb-ft, Rotax® 976 cc, V-twin, liquid-cooled	HD10 82 hp / 69 lb-ft, Rotax® 976 cc, V-twin, liquid-cooled
	Fuel Delivery System	Intelligent Throttle Control (ITC™) with Electronic Fuel Injection (EFI)		
	Transmission	pDrive primary CVT with engine braking and Electronic Drive Belt Protection L / H / N / R / P	PRO-TORQ CVT with Quick Response System (QRS), high airflow ventilation and Electronic Drive Belt Protection Extra-L / H / N / R / P	
	Drive Train	Selectable Turf Mode / 2WD / 4WD with Visco-Lok† QE auto-locking front differential	Selectable Turf Mode / 2WD / 4WD with Visco-Lok† auto-locking front differential	Selectable Turf Mode / 2WD / 4WD auto-locking front differential
	Driving Assistance	CVT engine braking ECO™ / ECO™ Off / Work modes Speed limiter		
	Power Steering	Dynamic Power Steering (DPS™)		
	SUSPENSIONS	Front Suspension	Double A-arm / 10 in. (25.4 cm) suspension travel	
Front Shocks		Twin-tube gas charged shocks		
Rear Suspension		TTA with external sway bar / 10 in. (25.4 cm) suspension travel		TTA with external sway bar / 10 in. (25.4 cm) suspension travel
Rear Shocks		Twin-tube gas charged shocks		
TIRES/ WHEELS	Front/Rear Tires	XPS Trail Force 27 x 9/11 x 14 in. 14 in. cast-aluminum		XPS Trail King 27 x 9/11 x 14 in. 14 in. cast-aluminum
	Wheels			
BRAKES	Front	Dual 220 mm disc brakes with hydraulic twin-piston calipers		
	Rear	Dual 220 mm disc brakes with hydraulic single-piston calipers		
	Brake Holding Mechanism	N/A		
DIMENSIONS / CAPACITIES	Cage	Profiled cage ROPS approved		
	Estimated Dry Weight	1,497 lb (679 kg)	1,567 lb (710 kg)	1,584 lb (719 kg)
	L x W x H	121 x 62 x 76 in. (307.1 x 157.5 x 193 cm)		121 x 64 x 78 in. (307.1 x 162.5 x 198.1 cm)
	Wheelbase	83 in. (211.5 cm)		
	Ground Clearance	11 in. (28 cm)		13 in. (33 cm)
	Cargo Box Dimensions	38 x 54.5 x 12 in. (96.5 x 138.4 x 30.5 cm)		
	Cargo Box Capacity	1,000 lb (454 kg) / California only: 600 lb (272.2 kg)		
	Power Tilt Bed	N/A		
	Tailgate Load Capacity	250 lb (113.4 kg)		
	Storage Capacity	Total: 10.4 gal (39.5 L)		
	Towing Capacity	2,500 lb (1,134 kg)		
	Payload Capacity	1,500 lb (680 kg)		
	Fuel Capacity	10.6 gal (40 L)		
Person Capacity	3			
FEATURES	Gauge	4.5 in. wide digital display		
	Battery	12 V (18 amp/h)		
	Magneto	650 W		
	Instrumentation	DC outlet (10 A)		
	Lighting	Front lighting output 140 W LED taillights		
	Winch	N/A		
	Seat	VERSA-PRO bench seat with passenger's seats flipping up Underside hooks		
	Steering Wheel	Tilt steering adjustment		
	Protection	Integrated front steel bumper Full heavy-duty HMW plastic skid plate		
	Hitch Type	2 in. hitch receiver		

†Visco-Lok is a trademark of GKN Viscodrives GmbH.

\*Smart-Lok was developed in conjunction with TEAM Industries, a market leader in the drive train industry.

\*\*\*1-year BRP limited warranty. B.E.S.T. term available up to 30 months.

			
	DEFENDER DPS CAB***	DEFENDER XT***	
<b>COLOR OPTIONS</b>	Compass Green	Dusty Navy Dark Wildland Camo	Dusty Navy Stealth Black Dark Wildland Camo
<b>ENGINES</b>	Type	HD9	HD7
		65 hp / 59 lb-ft, Rotax® 976 cc, V-twin, liquid-cooled	52 hp / 42 lb-ft, Rotax® ACE (Advanced Combustion Efficiency) 650 cc single cylinder, liquid-cooled
	Fuel Delivery System	Intelligent Throttle Control (ITC™) with Electronic Fuel Injection (EFI)	Intelligent Throttle Control (ITC™) with Electronic Fuel Injection (EFI)
	Transmission	PRO-TORQ CVT with Quick Response System (QRS), high airflow ventilation and Electronic Drive Belt Protection Extra-L / H / N / R / P	pDrive primary CVT with engine braking and Electronic Drive Belt Protection L / H / N / R / P
	Drive Train	Selectable Turf Mode / 2WD / 4WD with Visco-Lok® auto-locking front differential	Selectable Turf Mode / 2WD / 4WD with Visco-Lok® QE auto-locking front differential
	Driving Assistance	CVT engine braking ECO™ / ECO™ Off / Work modes Speed limiter	CVT engine braking ECO™ / ECO™ Off / Work modes Speed limiter
Power Steering	Dynamic Power Steering (DPS™)	Dynamic Power Steering (DPS™)	
<b>SUSPENSIONS</b>	Front Suspension	Arched double A-arm with swaybar / 12 in. (30.5 cm) suspension travel	Double A-arm / 10 in. (25.4 cm) suspension travel
	Front Shocks	Twin-tube gas charged shocks	Twin-tube gas charged shocks
	Rear Suspension	Arched TTA with external sway bar / 12 in. (30.5 cm) suspension travel	TTA with external sway bar / 10 in. (25.4 cm) suspension travel
	Rear Shocks	Twin-tube gas charged shocks	Twin-tube gas charged shocks
<b>TIRES / WHEELS</b>	Front/Rear Tires Wheels	XPS Trail Force 27 x 9/11 x 14 in. 14 in. cast-aluminum	XPS Trail Force 27 x 9/11 x 14 in. 14 in. cast-aluminum
<b>BRAKES</b>	Front	Dual 220 mm disc brakes with hydraulic twin-piston calipers	Dual 220 mm disc brakes with hydraulic twin-piston calipers
	Rear	Dual 220 mm disc brakes with hydraulic single-piston calipers	Dual 220 mm disc brakes with hydraulic single-piston calipers
	Brake Holding Mechanism	N/A	Brake holding mechanism
<b>DIMENSIONS / CAPACITIES</b>	Cage	Profiled cage ROPS approved	Profiled cage ROPS approved
	Estimated Dry Weight	1,856 lb (842 kg)	1,603 lb (729 kg)
	L x W x H	121 x 65 x 80 in. (307.1 x 165.1 x 226 cm)	125.7 x 62 x 78 in. (319.4 x 157.5 x 198.1 cm)
	Wheelbase	83 in. (211.5 cm)	83 in. (211.5 cm)
	Ground Clearance	13 in. (30.5 cm)	11 in. (28 cm)
	Cargo Box Dimensions	38 x 54.5 x 12 in. (96.5 x 138.4 x 30.5 cm)	38 x 54.5 x 12 in. (96.5 x 138.4 x 30.5 cm)
	Cargo Box Capacity	1,000 lb (454 kg) / California only: 600 lb (272.2 kg)	1,000 lb (454 kg) / California only: 600 lb (272.2 kg)
	Power Tilt Bed	N/A	N/A
	Tailgate Load Capacity	250 lb (113.4 kg)	250 lb (113.4 kg)
	Storage Capacity	Total: 10.4 gal (39.5 L)	Total: 16.2 gal (61.3 L)
	Towing Capacity	2,500 lb (1,134 kg)	2,500 lb (1,134 kg)
	Payload Capacity	1,200 lb (544 kg)	1,500 lb (680 kg)
Fuel Capacity	10.6 gal (40 L)	10.6 gal (40 L)	
Person Capacity	3	3	
<b>FEATURES</b>	Gauge	4.5 in. wide digital display	4.5 in. wide digital display
	Battery	12 V (30 amp/h)	12 V (30 amp/h)
	Magneto	650 W	650 W
	Instrumentation	DC outlet (10 A)	DC outlet (10 A) USB port (10 A) x 2
	Lighting	Front lighting output 140 W LED taillights	Front lighting output 140 W LED taillights
	Winch	N/A	4,500 lb (2,041 kg) winch with synthetic cable
	Seat	VERSA-PRO bench seat with passenger's seats flipping up Underside hooks	VERSA-PRO bolster bench seats with passenger's seats flipping up Adjustable driver's seat, underside hooks, reinforced XT seat skin
	Steering Wheel	Tilt steering adjustment	Tilt steering adjustment
	Protection	Integrated front steel bumper Full heavy-duty HMW plastic skid plate Full hard roof with liner and interior dome light Full color match doors with electric opening windows and door locks Fixed windshield with wiper/washer kit Rear glass window	XT front bumper Full heavy-duty HMW plastic skid plate Full hard roof
	Hitch Type	2 in. hitch receiver	2 in. hitch receiver

† Visco-Lok is a trademark of GKN Viscodrive GmbH.

\*Smart-Lok was developed in conjunction with TEAM Industries, a market leader in the drive train industry.

\*\*\*1-year BRP limited warranty. B.E.S.T. term available up to 30 months.



**DEFENDER MAX\*\*\***

<b>COLOR OPTIONS</b>		Compass Green	Compass Green
<b>ENGINES</b>	<b>Type</b>	HD7	HD9
	<b>Fuel Delivery System</b>	Intelligent Throttle Control (ITC™) with Electronic Fuel Injection (EFI)	
	<b>Transmission</b>	pDrive primary CVT with engine braking and Electronic Drive Belt Protection L / H / N / R / P	PRO-TORQ CVT with Quick Response System (QRS), high airflow ventilation and Electronic Drive Belt Protection Extra-L / H / N / R / P
	<b>Drive Train</b>	Selectable Turf Mode / 2WD / 4WD with Visco-Lok <sup>†</sup> auto-locking front differential	
	<b>Driving Assistance</b>	CVT engine braking ECO™ / ECO™ Off / Work modes Speed limiter	
	<b>Power Steering</b>	N/A	
	<b>SUSPENSIONS</b>	<b>Front Suspension</b>	Double A-arm / 10 in. (25.4 cm) suspension travel
<b>Front Shocks</b>		Twin-tube gas charged shocks	
<b>Rear Suspension</b>		TTA with external sway bar / 10 in. (25.4 cm) suspension travel	
<b>Rear Shocks</b>		Twin-tube gas charged shocks	
<b>TIRES/WHEELS</b>	XPS Trail Force 27 x 9/11 x 14 in. 14 in. steel		
<b>BRAKES</b>	<b>Front</b>	Dual 220 mm disc brakes with hydraulic twin-piston calipers	
	<b>Rear</b>	Dual 220 mm disc brakes with hydraulic twin-piston calipers	
	<b>Brake Holding Mechanism</b>	N/A	
<b>DIMENSIONS / CAPACITIES</b>	<b>Cage</b>	Profiled cage ROPS approved	
	<b>Estimated Dry Weight</b>	1,757 lb (797 kg)	1,789 lb (811 kg)
	<b>L x W x H</b>	153.4 x 63.5 x 76 in. (389.6 x 161.2 x 193 cm)	
	<b>Wheelbase</b>	115.5 in. (294 cm)	
	<b>Ground Clearance</b>	11 in. (28 cm)	
	<b>Cargo Box Dimensions</b>	38 x 54.5 x 12 in. (96.5 x 138.4 x 30.5 cm)	
	<b>Cargo Box Capacity</b>	1,000 lb (454 kg) / California only: 600 lb (272.2 kg)	
	<b>Power Tilt Bed</b>	N/A	
	<b>Tailgate Load Capacity</b>	250 lb (113.4 kg)	
	<b>Storage Capacity</b>	Total: 3.1 gal (11.7 L)	
	<b>Towing Capacity</b>	2,500 lb (1,134 kg)	
	<b>Payload Capacity</b>	1,700 lb (771 kg)	
	<b>Fuel Capacity</b>	10.6 gal (40 L)	
	<b>Person Capacity</b>	6	
<b>FEATURES</b>	<b>Gauge</b>	4.5 in. wide digital display	
	<b>Battery</b>	12 V (18 amp/h)	
	<b>Magneto</b>	650 W	
	<b>Instrumentation</b>	DC outlet (10 A)	
	<b>Lighting</b>	Front lighting output 140 W LED taillights	
	<b>Winch</b>	N/A	
	<b>Seat</b>	VERSA-PRO bench seat with passengers' seats flipping up Underside hooks	
	<b>Steering Wheel</b>	Tilt steering adjustment	
	<b>Protection</b>	Integrated front steel bumper Full heavy-duty HMW plastic skid plate	
	<b>Hitch Type</b>	2 in. hitch receiver	

†Visco-Lok is a trademark of GKN Viscodrive GmbH.  
 \*Smart-Lok was developed in conjunction with TEAM Industries, a market leader in the drive train industry.  
 \*\*\*1-year BRP limited warranty. B.E.S.T. term available up to 30 months.





**DEFENDER MAX DPS\*\*\***

<b>COLOR OPTIONS</b>		Compass Green Dark Wildland Camo	Compass Green Stealth Black Dark Wildland Camo	Compass Green
<b>ENGINES</b>	<b>Type</b>	HD7	HD9	HD10
		52 hp / 42 lb-ft, Rotax® ACE (Advanced Combustion Efficiency) 650 cc single cylinder, liquid-cooled		65 hp / 59 lb-ft, Rotax® 976 cc, V-twin, liquid-cooled
	<b>Fuel Delivery System</b>	Intelligent Throttle Control (iTC™) with Electronic Fuel Injection (EFI)		
	<b>Transmission</b>	pDrive primary CVT with engine braking and Electronic Drive Belt Protection L / H / N / R / P	PRO-TORQ CVT with Quick Response System (QRS), high airflow ventilation and Electronic Drive Belt Protection Extra-L / H / N / R / P	
	<b>Drive Train</b>	Selectable Turf Mode / 2WD / 4WD with Visco-Lok® QE auto-locking front differential	Selectable Turf Mode / 2WD / 4WD with Visco-Lok® auto-locking front differential	Selectable Turf Mode / 2WD / 4WD auto-locking front differential
	<b>Driving Assistance</b>	CVT engine braking ECO™ / ECO™ Off / Work modes Speed limiter		
	<b>Power Steering</b>	Dynamic Power Steering (DPS™)		
<b>SUSPENSIONS</b>	<b>Front Suspension</b>	Double A-arm / 10 in. (25.4 cm) suspension travel		Double A-arm / 10 in. (25.4 cm) suspension travel
	<b>Front Shocks</b>	Twin-tube gas charged shocks		
	<b>Rear Suspension</b>	TTA with external sway bar / 10 in. (25.4 cm) suspension travel		TTA with external sway bar / 10 in. (25.4 cm) suspension travel
	<b>Rear Shocks</b>	Twin-tube gas charged shocks		
<b>TIRES/ WHEELS</b>	XPS Trail Force 27 x 9/11 x 14 in. 14 in. cast-aluminum		XPS Trail King 27 x 9/11 x 14 in. 14 in. cast-aluminum	
<b>BRAKES</b>	<b>Front</b>	Dual 220 mm disc brakes with hydraulic twin-piston calipers		
	<b>Rear</b>	Dual 220 mm disc brakes with hydraulic twin-piston calipers		
	<b>Brake Holding Mechanism</b>	N/A		
<b>DIMENSIONS / CAPACITIES</b>	<b>Cage</b>	Profiled cage ROPS approved		
	<b>Estimated Dry Weight</b>	1,772 lb (803 kg)	1,807 lb (819 kg)	1,829 lb (829 kg)
	<b>L x W x H</b>	153.4 x 63.5 x 76 in. (389.6 x 161.2 x 193 cm)		153.4 x 64 x 77.5 in. (389.6 x 162.5 x 196.9 cm)
	<b>Wheelbase</b>	115.5 in. (294 cm)		
	<b>Ground Clearance</b>	11 in. (28 cm)		13 in. (33 cm)
	<b>Cargo Box Dimensions</b>	38 x 54.5 x 12 in. (96.5 x 138.4 x 30.5 cm)		
	<b>Cargo Box Capacity</b>	1,000 lb (454 kg) / California only: 600 lb (272.2 kg)		
	<b>Power Tilt Bed</b>	N/A		
	<b>Tailgate Load Capacity</b>	250 lb (113.4 kg)		
	<b>Storage Capacity</b>	Total: 11.1 gal (42.1 L)		
	<b>Towing Capacity</b>	2,500 lb (1,134 kg)		
	<b>Payload Capacity</b>	1,700 lb (771 kg)		
<b>Fuel Capacity</b>	10.6 gal (40 L)			
<b>Person Capacity</b>	6			
<b>FEATURES</b>	<b>Gauge</b>	4.5 in. wide digital display		
	<b>Battery</b>	12 V (18 amp/h)		
	<b>Magneto</b>	650 W		
	<b>Instrumentation</b>	DC outlet (10 A)		
	<b>Lighting</b>	Front lighting output 140 W LED taillights		
	<b>Winch</b>	N/A		
	<b>Seat</b>	VERSA-PRO bench seat with passengers' seats flipping up Underside hooks		
	<b>Steering Wheel</b>	Tilt steering adjustment		
	<b>Protection</b>	Integrated front steel bumper Full heavy-duty HMW plastic skid plate		
	<b>Hitch Type</b>	2 in. hitch receiver		

† Visco-Lok is a trademark of GKN Visco-drive GmbH.

\*Smart-Lok was developed in conjunction with TEAM Industries, a market leader in the drive train industry.

\*\*\*1-year BRP limited warranty. B.E.S.T. term available up to 30 months.

				
	DEFENDER MAX XT***	DEFENDER PRO DPS***	DEFENDER PRO XT***	
<b>COLOR OPTIONS</b>	Stealth Black Dusty Navy Dark Wildland Camo	Compass Green Yellow (INTL)	Stealth Black	
<b>ENGINES</b>	<b>Type</b>	HD9 65 hp / 59 lb-ft, Rotax® 976 cc, V-twin, liquid-cooled	HD10 82 hp / 69 lb-ft, Rotax® 976 cc, V-twin, liquid-cooled	HD10 82 hp / 69 lb-ft, Rotax® 976 cc, V-twin, liquid-cooled
	<b>Fuel Delivery System</b>	Intelligent Throttle Control (ITC™) with Electronic Fuel Injection (EFI)	Intelligent Throttle Control (ITC™) with Electronic Fuel Injection (EFI)	Intelligent Throttle Control (ITC™) with Electronic Fuel Injection (EFI)
	<b>Transmission</b>	PRO-TORQ CVT with Quick Response System (QRS), high airflow ventilation and Electronic Drive Belt Protection Extra-L / H / N / R / P	PRO-TORQ CVT with Quick Response System (QRS), high airflow ventilation and Electronic Drive Belt Protection Extra-L / H / N / R / P	PRO-TORQ CVT with Quick Response System (QRS), high airflow ventilation and Electronic Drive Belt Protection Extra-L / H / N / R / P
	<b>Drive Train</b>	Selectable Turf Mode / 2WD / 4WD with Visco-Lok† auto-locking front differential	Selectable Turf Mode / 2WD / 4WD auto-locking QE front differential	Selectable Turf Mode / 2WD / 4WD auto-locking QE front differential
	<b>Driving Assistance</b>	CVT engine braking ECO™ / ECO™ Off / Work modes Speed limiter	CVT engine braking ECO™ / ECO™ Off / Work modes Speed limiter	CVT engine braking ECO™ / ECO™ Off / Work modes Speed limiter
	<b>Power Steering</b>	Dynamic Power Steering (DPS™)	Dynamic Power Steering (DPS™)	Dynamic Power Steering (DPS™)
	<b>SUSPENSIONS</b>	<b>Front Suspension</b>	Double A-arm / 10 in. (25.4 cm) suspension travel	Arched double A-arm / 11 in. (27.9 cm) suspension travel
<b>Front Shocks</b>		Twin-tube gas charged shocks	Twin-tube gas charged shocks	Twin-tube gas charged shocks
<b>Rear Suspension</b>		TTA with external sway bar / 10 in. (25.4 cm) suspension travel	Arched TTA with external sway bar / 11 in. (27.9 cm) suspension travel	Arched TTA with external sway bar / 11 in. (27.9 cm) suspension travel
<b>Rear Shocks</b>		Twin-tube gas charged shocks	Twin-tube gas charged shocks	Twin-tube gas charged shocks
<b>TIRES / WHEELS</b>	<b>Front/Rear Tires</b> XPS Trail Force 27 x 9/11 x 14 in. 14 in. cast-aluminum	<b>Front/Rear Tires</b> XPS Trail King 27 x 9/11 x 14 in. 14 in. cast-aluminum	<b>Front/Rear Tires</b> XPS Trail King 27 x 9/11 x 14 in. 14 in. cast-aluminum	
<b>BRAKES</b>	<b>Front</b>	Dual 220 mm disc brakes with hydraulic twin-piston calipers	Dual 220 mm disc brakes with hydraulic twin-piston calipers	Dual 220 mm disc brakes with hydraulic twin-piston calipers
	<b>Rear</b>	Dual 220 mm disc brakes with hydraulic twin-piston calipers	Dual 220 mm disc brakes with hydraulic twin-piston calipers	Dual 220 mm disc brakes with hydraulic twin-piston calipers
	<b>Brake Holding Mechanism</b>	Brake holding mechanism	N/A	Brake holding mechanism
<b>DIMENSIONS / CAPACITIES</b>	<b>Cage</b>	Profiled cage ROPS approved	Profiled cage ROPS approved	Profiled cage ROPS approved
	<b>Estimated Dry Weight</b>	1,937 lb (879 kg)	1,851 lb (839 kg)	1,978 lb (897 kg)
	<b>L x W x H</b>	158.3 x 63.5 x 76 in. (402 x 161.2 x 193 cm)	154.1 x 64 x 78 in. (391.5 x 162.5 x 198.1 cm)	159.7 x 64 x 80 in. (405.7 x 162.5 x 203.3 cm)
	<b>Wheelbase</b>	115.5 in. (294 cm)	115.5 in. (294 cm)	115.5 in. (294 cm)
	<b>Ground Clearance</b>	11 in. (28 cm)	13 in. (33 cm)	13 in. (33 cm)
	<b>Cargo Box Dimensions</b>	38 x 54.5 x 12 in. (96.5 x 138.4 x 30.5 cm)	72 x 54.5 x 10 in. (180.3 x 138.4 x 25.4 cm)	72 x 54.5 x 10 in. (180.3 x 138.4 x 25.4 cm)
	<b>Cargo Box Capacity</b>	1,000 lb (454 kg) / California only: 600 lb (272.2 kg)	1,000 lb (454 kg) / California only: 600 lb (272.2 kg)	1,000 lb (454 kg) / California only: 600 lb (272.2 kg)
	<b>Power Tilt Bed</b>	N/A	N/A	Hydraulic power tilt bed
	<b>Tailgate Load Capacity</b>	250 lb (113.4 kg)	250 lb (113.4 kg)	250 lb (113.4 kg)
	<b>Storage Capacity</b>	Total: 16.9 gal (63.9 L)	Total: 94 gal (356 L)	Total: 100.5 gal (380.4 L)
	<b>Towing Capacity</b>	2,500 lb (1,134 kg)	2,500 lb (1,134 kg)	2,500 lb (1,134 kg)
	<b>Payload Capacity</b>	1,700 lb (771 kg)	1,570 lb (712 kg)	1,570 lb (712 kg)
	<b>Fuel Capacity</b>	10.6 gal (40 L)	10.6 gal (40 L)	10.6 gal (40 L)
<b>Person Capacity</b>	6	3	3	
<b>FEATURES</b>	<b>Gauge</b>	4.5 in. wide digital display	4.5 in. wide digital display	4.5 in. wide digital display
	<b>Battery</b>	12 V (30 amp/h)	12 V (18 amp/h)	12 V (30 amp/h)
	<b>Magneto</b>	650 W	650 W	650 W
	<b>Instrumentation</b>	DC outlet (10 A) USB port (10 A) x 2	DC outlet (10 A)	DC outlet (10 A) USB port (10 A) x 2
	<b>Lighting</b>	Front lighting output 140 W LED taillights	Front lighting output 140 W LED taillights	Front lighting output 140 W LED taillights
	<b>Winch</b>	4,500 lb (2,041 kg) winch with synthetic cable	N/A	4,500 lb (2,041 kg) winch with synthetic cable
	<b>Seat</b>	VERSA-PRO bolster bench seats with passenger seats flipping up Adjustable driver's seat, underside hooks, reinforced XT seat skin	VERSA-PRO bench seat with passenger's seats flipping up Underside hooks	VERSA-PRO bolster bench seats with passenger seats flipping up Adjustable driver's seat, underside hooks, reinforced XT seat skin
	<b>Steering Wheel</b>	Tilt steering adjustment	Tilt steering adjustment	Tilt steering adjustment
	<b>Protection</b>	XT front bumper Full heavy-duty HMW plastic skid plate 2-piece full hard roof	Integrated front steel bumper Full heavy-duty HMW plastic skid plate	XT front bumper Full heavy-duty HMW plastic skid plate Full hard roof
	<b>Hitch Type</b>	2 in. hitch receiver	2 in. hitch receiver	2 in. hitch receiver

† Visco-Lok is a trademark of GKN Viscodrive GmbH.

\*Smart-Lok was developed in conjunction with TEAM Industries, a market leader in the drive train industry.

\*\*\*1-year BRP limited warranty. B.E.S.T. term available up to 30 months.



**DEFENDER PRO LIMITED\*\*\***



**DEFENDER 6X6 DPS\*\*\***

COLOR OPTIONS		Dusty Navy	Compass Green
ENGINES	Type	HD10	HD10
	Fuel Delivery System	82 hp / 69 lb-ft, Rotax® 976 cc, V-twin, liquid-cooled	82 hp / 69 lb-ft, Rotax® 976 cc, V-twin, liquid-cooled
	Transmission	Intelligent Throttle Control (ITC™) with Electronic Fuel Injection (EFI)	Intelligent Throttle Control (ITC™) with Electronic Fuel Injection (EFI)
	Drive Train	PRO-TORQ CVT with Quick Response System (QRS), high airflow ventilation and Electronic Drive Belt Protection Extra-L / H / N / R / P	PRO-TORQ CVT with Quick Response System (QRS), high airflow ventilation and Electronic Drive Belt Protection Extra-L / H / N / R / P
	Driving Assistance	Selectable Turf Mode / 2WD / 4WD with exclusive Smart-Lok™*	Selectable 4WD / 6WD auto-locking QE front differential
	Power Steering	CVT engine braking ECO™ / ECO™ Off / Work modes Speed limiter	CVT engine braking ECO™ / ECO™ Off / Work modes Speed limiter
SUSPENSIONS	Front Suspension	Dynamic Power Steering (DPS™)	Dynamic Power Steering (DPS™)
	Front Shocks	Arched double A-arm with sway bar / 12 in. (30.5 cm) suspension travel	Arched double A-arm / 11 in. (27.9 cm) suspension travel
	Rear Suspension	Twin-tube gas charged shocks	Twin-tube gas charged shocks
	Rear Shocks	Arched TTA with external sway bar / 12 in. (30.5 cm) suspension travel	Arched TTA with external sway bar / 11 in. (27.9 cm) suspension travel
TIRES / WHEELS	Front/Rear Tires	XPS Trac Force 30 x 9/10 x 14 in. 14 in. cast-aluminum	XPS Trail King 27 x 9/11 x 14 in. 14 in. cast-aluminum
	Wheels		
BRAKES	Front	Dual 220 mm disc brakes with hydraulic twin-piston calipers	Dual 220 mm disc brakes with hydraulic twin-piston calipers
	Rear	Dual 220 mm disc brakes with hydraulic twin-piston calipers	Dual 220 mm disc brakes with hydraulic twin-piston calipers
	Brake Holding Mechanism	Brake holding mechanism	N/A
DIMENSIONS / CAPACITIES	Cage	Profilled cage ROPS approved	Profilled cage ROPS approved
	Estimated Dry Weight	2,345 lb (1,063 kg)	1,989 lb (902 kg)
	L x W x H	159.7 x 65 x 81 in. (405.7 x 165.1 x 228.7 cm)	154.1 x 64 x 78 in. (391.5 x 162.5 x 198.1 cm)
	Wheelbase	115.5 in. (294 cm)	115.5 in. (294 cm)
	Ground Clearance	14 in. (35.6 cm)	13 in. (33 cm)
	Cargo Box Dimensions	72 x 54.5 x 10 in. (180.3 x 138.4 x 25.4 cm)	72 x 54.5 x 10 in. (180.3 x 138.4 x 25.4 cm)
	Cargo Box Capacity	1,000 lb (454 kg) / California only: 600 lb (272.2 kg)	1,000 lb (454 kg) / California only: 600 lb (272.2 kg)
	Power Tilt Bed	Hydraulic power tilt bed	N/A
	Tailgate Load Capacity	250 lb (113.4 kg)	250 lb (113.4 kg)
	Storage Capacity	Total: 100.5 gal (380.4 L)	Total: 10.4 gal (39.5 L)
	Towing Capacity	2,500 lb (1,134 kg)	3,000 lb (1,360.8 kg)
	Payload Capacity	1,320 lb (598 kg)	1,700 lb (771 kg)
Fuel Capacity	10.6 gal (40 L)	10.6 gal (40 L)	
Person Capacity	3	3	
FEATURES	Gauge	7.6 in. wide digital display with keypad	4.5 in. wide digital display
	Battery	12 V (30 amp/h)	12 V (30 amp/h)
	Magneto	850 W	650 W
	Instrumentation	DC outlet (10 A) USB port (10 A) x 2	DC outlet (10 A)
	Lighting	Front lighting output 140 W LED signature LED taillights	Front lighting output 140 W LED taillights
	Winch	4,500 lb (2,041 kg) winch with synthetic cable	N/A
	Seat	VERSA-PRO bolster bench seats with passenger's seats flipping up Adjustable driver's seat, underside hooks, reinforced seat skin featuring Limited package trims	VERSA-PRO bench seat with passenger's seats flipping up Underside hooks
	Steering Wheel	Tilt steering adjustment	Tilt steering adjustment
	Protection	XT front bumper Full heavy-duty HMW plastic skid plate Full hard roof with liner and interior dome light Full color match doors with electric opening tinted windows and door locks 3-position full glass tilt up windshield with wiper/washer kit Rear glass window Panoramic mirror	Integrated front steel bumper Full heavy-duty HMW plastic skid plate
	Hitch Type	2 in. hitch receiver	2 in. hitch receiver

† Visco-Lok is a trademark of GKN Viscodrive GmbH.

\*Smart-Lok was developed in conjunction with TEAM Industries, a market leader in the drive train industry.



\*\*\*1-year BRP limited warranty. B.E.S.T. term available up to 30 months.

			
		DEFENDER 6X6 XT***	DEFENDER 6X6 LIMITED***
COLOR OPTIONS		Stealth Black	Dusty Navy
ENGINES	Type	HD10	HD10
	Fuel Delivery System	82 hp / 69 lb-ft, Rotax® 976 cc, V-twin, liquid-cooled	82 hp / 69 lb-ft, Rotax® 976 cc, V-twin, liquid-cooled
	Transmission	Intelligent Throttle Control (ITC™) with Electronic Fuel Injection (EFI)	Intelligent Throttle Control (ITC™) with Electronic Fuel Injection (EFI)
	Drive Train	PRO-TORQ CVT with Quick Response System (QRS), high airflow ventilation and Electronic Drive Belt Protection Extra-L / H / N / R / P	PRO-TORQ CVT with Quick Response System (QRS), high airflow ventilation and Electronic Drive Belt Protection Extra-L / H / N / R / P
	Driving Assistance	Selectable 4WD / 6WD auto-locking QE front differential	Selectable 4WD / 6WD with exclusive Smart-Lok™*
	Power Steering	CVT engine braking ECO™ / ECO™ Off / Work modes Speed limiter	CVT engine braking ECO™ / ECO™ Off / Work modes Speed limiter
	Power Steering	Dynamic Power Steering (DPS™)	Dynamic Power Steering (DPS™)
SUSPENSIONS	Front Suspension	Arched double A-arm / 11 in. (27.9 cm) suspension travel	Arched double A-arm with sway bar / 12 in. (30.5 cm) suspension travel
	Front Shocks	Twin-tube gas charged shocks	Twin-tube gas charged shocks
	Rear Suspension	Arched TTA with external sway bar / 11 in. (27.9 cm) suspension travel	Arched TTA with external sway bar / 12 in. (30.5 cm) suspension travel
	Rear Shocks	Twin-tube gas charged shocks	Twin-tube gas charged shocks
TIRES/ WHEELS	Front/Rear Tires Wheels	XPS Trail King 27 x 9/11 x 14 in. 14 in. cast-aluminum	XPS Trac Force 30 x 9/10 x 14 in. 14 in. cast-aluminum
BRAKES	Front	Dual 220 mm disc brakes with hydraulic twin-piston calipers	Dual 220 mm disc brakes with hydraulic twin-piston calipers
	Rear	Dual 220 mm disc brakes with hydraulic twin-piston calipers	Dual 220 mm disc brakes with hydraulic twin-piston calipers
	Brake Holding Mechanism	Brake holding mechanism	Brake holding mechanism
DIMENSIONS / CAPACITIES	Cage	Profiled cage ROPS approved	Profiled cage ROPS approved
	Estimated Dry Weight	2,077 lb (942 kg)	2,470 lb (1,120 kg)
	L x W x H	159.7 x 64 x 80 in. (405.7 x 162.5 x 203.3 cm)	159.7 x 65 x 81 in. (405.7 x 165.1 x 228.7 cm)
	Wheelbase	115.5 in. (294 cm)	115.5 in. (294 cm)
	Ground Clearance	13 in. (33 cm)	14 in. (35.6 cm)
	Cargo Box Dimensions	72 x 54.5 x 10 in. (180.3 x 138.4 x 25.4 cm)	72 x 54.5 x 10 in. (180.3 x 138.4 x 25.4 cm)
	Cargo Box Capacity	1,000 lb (454 kg) / California only: 600 lb (272.2 kg)	1,000 lb (454 kg) / California only: 600 lb (272.2 kg)
	Power Tilt Bed	Hydraulic power tilt bed	Hydraulic power tilt bed
	Tailgate Load Capacity	250 lb (113.4 kg)	250 lb (113.4 kg)
	Storage Capacity	Total: 16.9 gal (63.9 L)	Total: 16.9 gal (63.9 L)
	Towing Capacity	3,000 lb (1,360.8 kg)	3,000 lb (1,360.8 kg)
	Payload Capacity	1,570 lb (712 kg)	1,200 lb (544 kg)
	Fuel Capacity	10.6 gal (40 L)	10.6 gal (40 L)
Person Capacity	3	3	
FEATURES	Gauge	4.5 in. wide digital display	7.6 in. wide digital display with keypad
	Battery	12 V (30 amp/h)	12 V (30 amp/h)
	Magneto	650 W	850 W
	Instrumentation	DC outlet (10 A) USB port (10 A) x 2	DC outlet (10 A) USB port (10 A) x 2
	Lighting	Front lighting output 140 W LED taillights	Front lighting output 140 W LED signature LED taillights
	Winch	4,500 lb (2,041 kg) winch with synthetic cable	4,500 lb (2,041 kg) winch with synthetic cable
	Seat	VERSA-PRO bolster bench seats with passenger's seats flipping up Adjustable driver's seat, underside hooks, reinforced XT seat skin	VERSA-PRO bolster bench seats with passenger's seats flipping up Adjustable driver's seat, underside hooks, reinforced seat skin featuring Limited package trims
	Steering Wheel	Tilt steering adjustment	Tilt steering adjustment
	Protection	XT front bumper Full heavy-duty HMW plastic skid plate Full hard roof	XT front bumper Full heavy-duty HMW plastic skid plate Full hard roof with liner and interior dome light Full color match doors with electric opening tinted windows and door locks 3-position full glass tilt up windshield with wiper/washer kit Rear glass Panoramic mirror
	Hitch Type	2 in. hitch receiver	2 in. hitch receiver

† Visco-Lok is a trademark of GKN Viscodrive GmbH.

\* Smart-Lok was developed in conjunction with TEAM Industries, a market leader in the drive train industry.



\*\*\* 1-year BRP limited warranty. B.E.S.T. term available up to 30 months.

			
	<b>DEFENDER X MR***</b>	<b>DEFENDER X MR WITH HALF DOORS***</b>	
<b>COLOR OPTIONS</b>	Dark Wildland Camo	Loft Green Satin Dark Wildland Camo	
<b>ENGINES</b>	Type	HD11 95 hp / 70 lb-ft Rotax® ACE (Advanced Combustion Efficiency) 999 cc triple cylinder, liquid-cooled	HD11 95 hp / 70 lb-ft Rotax® ACE (Advanced Combustion Efficiency) 999 cc triple cylinder, liquid-cooled
	Fuel Delivery System	Intelligent Throttle Control (ITC™) with Electronic Fuel Injection (EFI)	Intelligent Throttle Control (ITC™) with Electronic Fuel Injection (EFI)
	Transmission	pDrive primary and Quick Response System X (QRS-X) CVT with high airflow, strategically positioned CVT air intakes and exhaust. Lower gearing ratio and Electronic Drive Belt Protection Extra-L / H / N / R / P	pDrive primary and Quick Response System X (QRS-X) CVT with high airflow, strategically positioned CVT air intakes and exhaust. Lower gearing ratio and Electronic Drive Belt Protection Extra-L / H / N / R / P
	Drive Train	Turf Mode and lockable front differential with exclusive Smart-Lok™ technology. True 4-mode traction system: 2WD / 4WD with front diff. lock / 4WD MUD / 4WD TRAIL	Turf Mode and lockable front differential with exclusive Smart-Lok™ technology. True 4-mode traction system: 2WD / 4WD with front diff. lock / 4WD MUD / 4WD TRAIL
	Driving Assistance	CVT engine braking Sport / Normal / Work modes Speed limiter	CVT engine braking Sport / Normal / Work modes Speed limiter
	Power Steering	High torque Tri-Mode Dynamic Power Steering (DPS™)	High torque Tri-Mode Dynamic Power Steering (DPS™)
	<b>SUSPENSIONS</b>	Front Suspension	Arched double A-arm with sway bar / 12 in. (30.5 cm) suspension travel
Front Shocks		Twin-tube gas charged shocks	Twin-tube gas charged shocks
Rear Suspension		Arched double A-arm / 12 in. (30.5 cm) suspension travel	Arched double A-arm / 12 in. (30.5 cm) suspension travel
Rear Shocks		Twin-tube gas charged shocks	Twin-tube gas charged shocks
<b>TIRES/ WHEELS</b>	Front/Rear Tires Wheels	XPS Swamp Force 30 x 9/11 x 14 in. 14 in. cast-aluminum	XPS Swamp Force 30 x 9/11 x 14 in. 14 in. cast-aluminum
<b>BRAKES</b>	Front	Dual 262 mm disc brakes with hydraulic twin-piston calipers (32 mm)	Dual 262 mm disc brakes with hydraulic twin-piston calipers (32 mm)
	Rear	Dual 236 mm disc brakes with hydraulic single-piston caliper (32 mm)	Dual 236 mm disc brakes with hydraulic single-piston caliper (32 mm)
	Brake Holding Mechanism	Brake holding mechanism	Brake holding mechanism
<b>DIMENSIONS / CAPACITIES</b>	Cage	Profiled cage ROPS approved	Profiled cage ROPS approved
	Estimated Dry Weight	1,920 lb (871 kg)	2,010 lb (912 kg)
	L x W x H	131.7 x 65 x 79.8 in. (335 x 165 x 203 cm)	131.7 x 65 x 79.8 in. (335 x 165 x 203 cm)
	Wheelbase	85 in. (216 cm)	85 in. (216 cm)
	Ground Clearance	15 in. (38.1 cm)	15 in. (38.1 cm)
	Cargo Box Dimensions	38 x 54.5 x 12 in. (96.5 x 138.4 x 30.5 cm)	38 x 54.5 x 12 in. (96.5 x 138.4 x 30.5 cm)
	Cargo Box Capacity	1,000 lb (454 kg) / California only: 600 lb (272.2 kg)	1,000 lb (454 kg) / California only: 600 lb (272.2 kg)
	Power Tilt Bed	N/A	N/A
	Tailgate Load Capacity	250 lb (113.4 kg)	250 lb (113.4 kg)
	Storage Capacity	Weather resistant above gage glove box Weather resistant passenger glove box with USB-C, USB-A & DC outlet Cubby storage and lower dash storage 3.7 gal (14 L) under seat removable bin	Weather resistant above gage glove box Weather resistant passenger glove box with USB-C, USB-A & DC outlet Cubby storage and lower dash storage 3.7 gal (14 L) under seat removable bin
	Towing Capacity	2,500 lb (1,134 kg)	2,500 lb (1,134 kg)
	Payload Capacity	1,500 lb (680 kg)	1,500 lb (680 kg)
	Fuel Capacity	11.9 gal (45 L)	11.9 gal (45 L)
Person Capacity	3	3	
<b>FEATURES</b>	Gauge	4.5 in. wide digital display with keypad	4.5 in. wide digital display with keypad
	Battery	400 CCA (32 amp/h)	400 CCA (32 amp/h)
	Magneto	650 W	650 W
	Instrumentation	USB outlets Lighter DC outlet	USB outlets Lighter DC outlet
	Anti-theft System	RF Digitally Encoded Security System (D.E.S.S.™) with Start/Stop button	RF Digitally Encoded Security System (D.E.S.S.™) with Start/Stop button
	Lighting	LED headlights LED taillights with back up light LED signature	LED headlights LED taillights with back up light LED signature
	Winch	Relocated 4,500 lb (2,041 kg) winch with synthetic cable and autostop	Relocated 4,500 lb (2,041 kg) winch with synthetic cable and autostop
	Seat	Adjustable driver's seat 40/20/40 bolster	Adjustable driver's seat 40/20/40 bolster
	Steering Wheel	Premium steering wheel Adjustable steering wheel with full tilt-up feature	Premium steering wheel Adjustable steering wheel with full tilt-up feature
	Protection	Full heavy-duty HMW plastic skid plate Large heavy-duty front bumper Steel rock sliders Wide mudguards Door safety net Front anchor	Full heavy-duty HMW plastic skid plate Large heavy-duty front bumper Steel rock sliders Wide mudguards Half doors Front anchor
	Hitch Type	2 in. hitch receiver	2 in. hitch receiver

† Visco-Lok is a trademark of GKN Viscodrive GmbH.

\*Smart-Lok was developed in conjunction with TEAM Industries, a market leader in the drive train industry.

\*\*\*1-year BRP limited warranty. B.E.S.T. term available up to 30 months.

			
	<b>DEFENDER XT***</b>	<b>DEFENDER XT CAB***</b>	
<b>COLOR OPTIONS</b>	Dark Wildland Camo Dusty Navy Stealth Black	Dark Wildland Camo Dusty Navy Stealth Black	
<b>ENGINES</b>	Type	HD11 95 hp / 70 lb-ft Rotax® ACE (Advanced Combustion Efficiency) 999 cc triple cylinder, liquid-cooled	HD11 95 hp / 70 lb-ft Rotax® ACE (Advanced Combustion Efficiency) 999 cc triple cylinder, liquid-cooled
	Fuel Delivery System	Intelligent Throttle Control (ITC™) with Electronic Fuel Injection (EFI)	Intelligent Throttle Control (ITC™) with Electronic Fuel Injection (EFI)
	Transmission	pDrive primary and Quick Response System X (QRS-X) CVT with high airflow and Electronic Drive Belt Protection L / H / N / R / P	pDrive primary and Quick Response System X (QRS-X) CVT with high airflow and Electronic Drive Belt Protection L / H / N / R / P
	Drive Train	Selectable Turf Mode / 2WD / 4WD with Quick-4Lok™ auto-locking front differential	Selectable Turf Mode / 2WD / 4WD with Quick-4Lok™ auto-locking front differential
	Driving Assistance	CVT engine braking Sport / Normal / Work modes Speed limiter	CVT engine braking Sport / Normal / Work modes Speed limiter
	Power Steering	High torque Tri-Mode Dynamic Power Steering (DPS™)	High torque Tri-Mode Dynamic Power Steering (DPS™)
	<b>SUSPENSIONS</b>	Front Suspension	Arched double A-arm with sway bar / 12 in. (30.5 cm) suspension travel
Front Shocks		Twin-tube gas charged shocks	Twin-tube gas charged shocks
Rear Suspension		Arched double A-arm / 12 in. (30.5 cm) suspension travel	Arched double A-arm / 12 in. (30.5 cm) suspension travel
Rear Shocks		Twin-tube gas charged shocks	Twin-tube gas charged shocks
<b>TIRES/ WHEELS</b>	Front/Rear Tires Wheels	XPS Trail King 2 29 x 9/11 x 14 in. 14 in. cast-aluminum	XPS Trail King 2 29 x 9/11 x 14 in. 14 in. cast-aluminum
<b>BRAKES</b>	Front	Dual 262 mm disc brakes with hydraulic twin-piston calipers (32 mm)	Dual 262 mm disc brakes with hydraulic twin-piston calipers (32 mm)
	Rear	Dual 236 mm disc brakes with hydraulic single-piston caliper (32 mm)	Dual 236 mm disc brakes with hydraulic single-piston caliper (32 mm)
	Brake Holding Mechanism	Brake holding mechanism	Brake holding mechanism
<b>DIMENSIONS / CAPACITIES</b>	Cage	Profiled cage ROPS approved	Profiled cage ROPS approved
	Estimated Dry Weight	1,870 lb (848 kg)	2,165 lb (982 kg)
	L x W x H	129.8 x 65 x 81 in. (330 x 165 x 206 cm)	129.8 x 65 x 81 in. (330 x 165 x 206 cm)
		85 in. (216 cm)	85 in. (216 cm)
	Ground Clearance	14 in. (35.6 cm)	14 in. (35.6 cm)
	Cargo Box Dimensions	38 x 54.5 x 12 in. (96.5 x 138.4 x 30.5 cm)	38 x 54.5 x 12 in. (96.5 x 138.4 x 30.5 cm)
	Cargo Box Capacity	1,000 lb (454 kg) / California only: 600 lb (272.2 kg)	1,000 lb (454 kg) / California only: 600 lb (272.2 kg)
	Power Tilt Bed	N/A	N/A
		250 lb (113.4 kg)	250 lb (113.4 kg)
	Storage Capacity	Weather resistant above gage glove box including protected cellphone area, USB-A plug if vehicle is equipped with 10.25 infotainment Weather resistant passenger glove box with USB-C, USB-A & DC outlet Cubby storage and lower dash storage 3.7 gal (14 L) removable bin	Weather resistant above gage glove box including protected cellphone area, USB-A plug if vehicle is equipped with 10.25 infotainment Weather resistant passenger glove box with USB-C, USB-A & DC outlet Cubby storage and lower dash storage 3.7 gal (14 L) removable bin
Towing Capacity	2,500 lb (1,134 kg)	2,500 lb (1,134 kg)	
Payload Capacity	1,500 lb (680 kg)	1,200 lb (545 kg)	
Fuel Capacity	11.9 gal (45 L)	11.9 gal (45 L)	
Person Capacity	3	3	
<b>FEATURES</b>	Gauge	4.5 in. wide digital display with keypad OR 4.5 in. wide digital display with keypad & 10.25 in. touchscreen display	4.5 in. wide digital display with keypad OR 4.5 in. wide digital display with keypad & 10.25 in. touchscreen display
	Battery	400 CCA (32 amp/h) 12 V (cargo outlet)	400 CCA (32 amp/h) 12 V (cargo outlet)
	Magneto	650 W	1,700 W
	Instrumentation	USB outlets Lighter DC outlet Cargo 12 V Outlet	USB outlets Lighter DC outlet Cargo 12 V Outlet
	Anti-theft System	RF Digitally Encoded Security System (D.E.S.S.™) with Start/Stop button	RF Digitally Encoded Security System (D.E.S.S.™) with Start/Stop button
	Lighting	LED headlights LED taillights with back up light	LED headlights LED taillights with back up light
	Winch	4,500 lb (2,041 kg) winch with synthetic cable	4,500 lb (2,041 kg) winch with synthetic cable
	Seat	Adjustable driver's seat 40/20/40 bolster	Adjustable driver's seat 40/20/40 bolster
	Steering Wheel	Premium steering wheel Adjustable steering wheel with full tilt-up feature	Premium steering wheel Adjustable steering wheel with full tilt-up feature
	Protection	Full heavy-duty HMW plastic skid plate Full hard roof Heavy-duty front bumper Mudguards Door safety net	Full glass fixed windshield with wiper kit Full color match doors with locks and electric opening windows Rear clear glass window Full heavy-duty HMW plastic skid plate Full hard roof with liner and dome light Heavy-duty front bumper Mudguards
	Hitch Type	2 in. hitch receiver	2 in. hitch receiver

† Visco-Lok is a trademark of GKN Viscodrive GmbH.  
\* Smart-Lok was developed in conjunction with TEAM Industries, a market leader in the drive train industry.  
\*\*\* 1-year BRP limited warranty. B.E.S.T. term available up to 30 months.





	DEFENDER LIMITED***	DEFENDER MAX X MR WITH HALF DOORS***
<b>COLOR OPTIONS</b>	Hybrid White Desert Tan & Carbon Black Dark Wildland Camo Dusty Navy	Loft Green Satin Dark Wildland Camo
<b>ENGINES</b>	Type	HD11
	Fuel Delivery System	Intelligent Throttle Control (ITC™) with Electronic Fuel Injection (EFI)
	Transmission	pDrive primary and Quick Response System X (QRS-X) CVT with high airflow and Electronic Drive Belt Protection L / H / N / R / P
	Drive Train	Selectable Turf Mode / 2WD / 4WD with exclusive Smart-Lok™*
	Driving Assistance	CVT engine braking Sport / Normal / Work modes Speed limiter
	Power Steering	High torque Tri-Mode Dynamic Power Steering (DPS™)
<b>SUSPENSIONS</b>	Front Suspension	Arched double A-arm with sway bar / 12 in. (30.5 cm) suspension travel
	Front Shocks	Twin-tube gas charged shocks
	Rear Suspension	Arched double A-arm / 12 in. (30.5 cm) suspension travel
	Rear Shocks	Twin-tube gas charged shocks
<b>TIRES/WHEELS</b>	XPS Trac Force 30 x 9/10 x 15 in. 15 in. cast-aluminum	XPS Swamp Force 30 x 9/11 x 14 in. 14 in. cast-aluminum
<b>BRAKES</b>	Front	Dual 262 mm disc brakes with hydraulic twin-piston calipers (32 mm)
	Rear	Dual 236 mm disc brakes with hydraulic single-piston caliper (32 mm)
	Brake Holding Mechanism	Brake holding mechanism
<b>DIMENSIONS / CAPACITIES</b>	Cage	Profiled cage ROPS approved
	Estimated Dry Weight	2,265 lb (1,027 kg)
	L x W x H	129.8 x 65 x 81 in. (330 x 165 x 206 cm)
	Wheelbase	85 in. (216 cm)
	Ground Clearance	14 in. (35.6 cm)
	Cargo Box Dimensions	38 x 54.5 x 12 in. (96.5 x 138.4 x 30.5 cm)
	Cargo Box Capacity	1,000 lb (454 kg) / California only: 600 lb (272.2 kg)
	Power Tilt Bed	N/A
	Tailgate Load Capacity	250 lb (113.4 kg)
	Storage Capacity	Weather resistant above gage glove box including protected cellphone area and USB-A plug Weather resistant passenger glove box with USB-C, USB-A & DC outlet Cubby storage and lower dash storage 3.7 gal (14 L) removable bin
	Towing Capacity	2,500 lb (1,134 kg)
Payload Capacity	1,200 lb (545 kg)	
Fuel Capacity	11.9 gal (45 L)	
Person Capacity	3	
<b>FEATURES</b>	Gauge	4.5 in. wide digital display with keypad & 10.25 in. touchscreen display
	Battery	400 CCA (32 amp/h) 12 V (cargo outlet)
	Magneto	1,700 W
	Instrumentation	USB outlets Lighter DC outlet Cargo 12V Outlet
	Anti-theft System	RF Digitally Encoded Security System (D.E.S.S.™) with Start/Stop button
	Lighting	LED headlights LED taillights with back up light LED signature
	Winch	4,500 lb (2,041 kg) winch with synthetic cable and autostop
	Seat	Adjustable driver's seat 40/20/40 bolster
	Steering Wheel	Premium steering wheel with keypad Adjustable steering wheel with full tilt-up feature
	Protection	Full glass tilt up windshield with wiper kit Full color match doors with locks and electric opening tinted windows Rear tinted glass window Panoramic mirror Full heavy-duty HMW plastic skid plate Full hard roof with liner and dome light Large heavy-duty front bumper Mudguards Floor mats
	Hitch Type	2 in. hitch receiver



† Visco-Lok is a trademark of GKN Visco-drive GmbH.

\*Smart-Lok was developed in conjunction with TEAM Industries, a market leader in the drive train industry.

\*\*\*1-year BRP limited warranty. B.E.S.T. term available up to 30 months.

			
	<b>DEFENDER MAX XT***</b>	<b>DEFENDER MAX XT CAB***</b>	
<b>COLOR OPTIONS</b>	Dark Wildland Camo Dusty Navy Stealth Black	Dark Wildland Camo Dusty Navy Stealth Black	
<b>ENGINES</b>	Type	HD11 95 hp / 70 lb-ft Rotax® ACE (Advanced Combustion Efficiency) 999 cc triple cylinder, liquid-cooled	HD11 95 hp / 70 lb-ft Rotax® ACE (Advanced Combustion Efficiency) 999 cc triple cylinder, liquid-cooled
	Fuel Delivery System	Intelligent Throttle Control (ITC™) with Electronic Fuel Injection (EFI)	Intelligent Throttle Control (ITC™) with Electronic Fuel Injection (EFI)
	Transmission	pDrive primary and Quick Response System X (QRS-X) CVT with high airflow and Electronic Drive Belt Protection L / H / N / R / P	pDrive primary and Quick Response System X (QRS-X) CVT with high airflow and Electronic Drive Belt Protection L / H / N / R / P
	Drive Train	Selectable Turf Mode / 2WD / 4WD with Quick-4Lok™ auto-locking front differential	Selectable Turf Mode / 2WD / 4WD with Quick-4Lok™ auto-locking front differential
	Driving Assistance	CVT engine braking Sport / Normal / Work modes Speed limiter	CVT engine braking Sport / Normal / Work modes Speed limiter
	Power Steering	High torque Tri-Mode Dynamic Power Steering (DPS™)	High torque Tri-Mode Dynamic Power Steering (DPS™)
<b>SUSPENSIONS</b>	Front Suspension	Arched double A-arm with sway bar / 12 in. (30.5 cm) suspension travel	Arched double A-arm with sway bar / 12 in. (30.5 cm) suspension travel
	Front Shocks	Twin-tube gas charged shocks	Twin-tube gas charged shocks
	Rear Suspension	Arched double A-arm / 12 in. (30.5 cm) suspension travel	Arched double A-arm / 12 in. (30.5 cm) suspension travel
	Rear Shocks	Twin-tube gas charged shocks	Twin-tube gas charged shocks
<b>TIRES/ WHEELS</b>	Front/Rear Tires Wheels	XPS Trail King 2 29 x 9/11 x 14 in. 14 in. cast-aluminum	XPS Trail King 2 29 x 9/11 x 14 in. 14 in. cast-aluminum
<b>BRAKES</b>	Front	Dual 262 mm disc brakes with hydraulic twin-piston calipers (32 mm)	Dual 262 mm disc brakes with hydraulic twin-piston calipers (32 mm)
	Rear	Dual 236 mm disc brakes with hydraulic twin-piston calipers (28 mm)	Dual 236 mm disc brakes with hydraulic twin-piston calipers (28 mm)
	Brake Holding Mechanism	Brake holding mechanism	Brake holding mechanism
<b>DIMENSIONS / CAPACITIES</b>	Cage	Profiled cage ROPS approved	Profiled cage ROPS approved
	Estimated Dry Weight	2,170 lb (984 kg)	2,615 lb (1,186 kg)
	L x W x H	162.4 x 65 x 81.4 in. (412 x 165 x 207 cm)	162.4 x 65 x 81.4 in. (412 x 165 x 207 cm)
	Wheelbase	117.5 in. (298 cm)	117.5 in. (298 cm)
	Ground Clearance	14 in. (35.6 cm)	14 in. (35.6 cm)
	Cargo Box Dimensions	38 x 54.5 x 12 in. (96.5 x 138.4 x 30.5 cm)	38 x 54.5 x 12 in. (96.5 x 138.4 x 30.5 cm)
	Cargo Box Capacity	1,000 lb (454 kg) / California only: 600 lb (272.2 kg)	700 lb (318 kg) / California only: 600 lb (272.2 kg)
	Power Tilt Bed	N/A	N/A
	Tailgate Load Capacity	250 lb (113.4 kg)	250 lb (113.4 kg)
	Storage Capacity	Weather resistant above gage glove box including protected cellphone area, USB-A plug if vehicle is equipped with 10.25 infotainment Weather resistant passenger glove box with USB-C, USB-A & DC outlet Cubby storage and lower dash storage 3.7 gal (14 L) removable bin	Weather resistant above gage glove box including protected cellphone area, USB-A plug if vehicle is equipped with 10.25 infotainment Weather resistant passenger glove box with USB-C, USB-A & DC outlet Cubby storage and lower dash storage 3.7 gal (14 L) removable bin
	Towing Capacity	2,500 lb (1,134 kg)	2,500 lb (1,134 kg)
	Payload Capacity	1,475 lb (669 kg)	1,030 lb (467 kg)
	Fuel Capacity	11.9 gal (45 L)	11.9 gal (45 L)
Person Capacity	6	6	
<b>FEATURES</b>	Gauge	4.5 in. wide digital display with keypad OR 4.5 in. wide digital display with keypad & 10.25 in. touchscreen display	4.5 in. wide digital display with keypad OR 4.5 in. wide digital display with keypad & 10.25 in. touchscreen display
	Battery	400 CCA (32 amp/h) 12 V (cargo outlet)	400 CCA (32 amp/h) 12 V (cargo outlet)
	Magneto	650 W	1,700 W
	Instrumentation	USB outlets Lighter DC outlet Cargo 12V Outlet	USB outlets Lighter DC outlet Cargo 12V Outlet
	Anti-theft System	RF Digitally Encoded Security System (D.E.S.S.™) with Start/Stop button	RF Digitally Encoded Security System (D.E.S.S.™) with Start/Stop button
	Lighting	LED headlights LED taillights with back up light	LED headlights LED taillights with back up light
	Winch	4,500 lb (2,041 kg) winch with synthetic cable	4,500 lb (2,041 kg) winch with synthetic cable
	Seat	Adjustable driver's seat 40/20/40 bolster	Adjustable driver's seat 40/20/40 bolster
	Steering Wheel	Premium steering wheel Adjustable steering wheel with full tilt-up feature	Premium steering wheel Adjustable steering wheel with full tilt-up feature
	Protection	Full heavy-duty HMW plastic skid plate Full hard roof Heavy-duty front bumper Mudguards Door safety net	Full glass fixed windshield with wiper kit Full color match doors with locks and electric opening windows Rear clear glass window Full heavy-duty HMW plastic skid plate Full hard roof with liner and dome light Heavy-duty front bumper Mudguards
	Hitch Type	2 in. hitch receiver	2 in. hitch receiver

† Visco-Lok is a trademark of GKN Viscodrive GmbH.  
\* Smart-Lok was developed in conjunction with TEAM Industries, a market leader in the drive train industry.  
\*\*\* 1-year BRP limited warranty. B.E.S.T. term available up to 30 months.

				
	DEFENDER MAX LONE STAR***	DEFENDER MAX LONE STAR CAB***	DEFENDER MAX LIMITED***	
COLOR OPTIONS	Stealth Black	Stealth Black	Hybrid White Desert Tan & Carbon Black Dark Wildland Camo Dusty Navy	
ENGINES	Type	HD11 95 hp / 70 lb-ft Rotax® ACE (Advanced Combustion Efficiency) 999 cc triple cylinder, liquid-cooled	HD11 95 hp / 70 lb-ft Rotax® ACE (Advanced Combustion Efficiency) 999 cc triple cylinder, liquid-cooled	HD11 95 hp / 70 lb-ft Rotax® ACE (Advanced Combustion Efficiency) 999 cc triple cylinder, liquid-cooled
	Fuel Delivery System	Intelligent Throttle Control (ITC™) with Electronic Fuel Injection (EFI)	Intelligent Throttle Control (ITC™) with Electronic Fuel Injection (EFI)	Intelligent Throttle Control (ITC™) with Electronic Fuel Injection (EFI)
	Transmission	pDrive primary and Quick Response System X (QRS-X) CVT with high airflow and Electronic Drive Belt Protection L / H / N / R / P	pDrive primary and Quick Response System X (QRS-X) CVT with high airflow and Electronic Drive Belt Protection L / H / N / R / P	pDrive primary and Quick Response System X (QRS-X) CVT with high airflow and Electronic Drive Belt Protection L / H / N / R / P
	Drive Train	Selectable Turf Mode / 2WD / 4WD with exclusive Smart-Lok™†	Selectable Turf Mode / 2WD / 4WD with exclusive Smart-Lok™†	Selectable Turf Mode / 2WD / 4WD with exclusive Smart-Lok™†
	Driving Assistance	CVT engine braking Sport / Normal / Work modes Speed limiter	CVT engine braking Sport / Normal / Work modes Speed limiter	CVT engine braking Sport / Normal / Work modes Speed limiter
	Power Steering	High torque Tri-Mode Dynamic Power Steering (DPS™)	High torque Tri-Mode Dynamic Power Steering (DPS™)	High torque Tri-Mode Dynamic Power Steering (DPS™)
SUSPENSIONS	Front Suspension	Arched double A-arm with sway bar / 12 in. (30.5 cm) suspension travel	Arched double A-arm with sway bar / 12 in. (30.5 cm) suspension travel	Arched double A-arm with sway bar / 12 in. (30.5 cm) suspension travel
	Front Shocks	Twin-tube gas charged shocks	Twin-tube gas charged shocks	Twin-tube gas charged shocks
	Rear Suspension	Arched double A-arm / 12 in. (30.5 cm) suspension travel	Arched double A-arm / 12 in. (30.5 cm) suspension travel	Arched double A-arm / 12 in. (30.5 cm) suspension travel
	Rear Shocks	Twin-tube gas charged shocks	Twin-tube gas charged shocks	Twin-tube gas charged shocks
TIRES/ WHEELS	Front/Rear Tires Wheels	XPS Trac Force 30 x 9/10 x 15 in. 15 in. cast-aluminum	XPS Trac Force 30 x 9/10 x 15 in. 15 in. cast-aluminum	XPS Trac Force 30 x 9/10 x 15 in. 15 in. cast-aluminum
BRAKES	Front	Dual 262 mm disc brakes with hydraulic twin-piston calipers (32 mm)	Dual 262 mm disc brakes with hydraulic twin-piston calipers (32 mm)	Dual 262 mm disc brakes with hydraulic twin-piston calipers (32 mm)
	Rear	Dual 236 mm disc brakes with hydraulic twin-piston calipers (28 mm)	Dual 236 mm disc brakes with hydraulic twin-piston calipers (28 mm)	Dual 236 mm disc brakes with hydraulic twin-piston calipers (28 mm)
	Brake Holding Mechanism	Brake holding mechanism	Brake holding mechanism	Brake holding mechanism
DIMENSIONS / CAPACITIES	Cage	Profiled cage ROPS approved	Profiled cage ROPS approved	Profiled cage ROPS approved
	Estimated Dry Weight	2,200 lb (998 kg)	2,755 lb (1,250 kg)	2,645 lb (1,200 kg)
	L x W x H	162.4 x 65 x 81.9 in. (412 x 165 x 208 cm)	162.4 x 65 x 82.6 in. (412 x 165 x 210 cm)	162.4 x 65 x 81.4 in. (412 x 165 x 207 cm)
	Wheelbase	117.5 in. (298 cm)	117.5 in. (298 cm)	117.5 in. (298 cm)
	Ground Clearance	14.5 in. (36.8 cm)	14 in. (35.6 cm)	14 in. (35.6 cm)
	Cargo Box Dimensions	38 x 54.5 x 12 in. (96.5 x 138.4 x 30.5 cm)	38 x 54.5 x 12 in. (96.5 x 138.4 x 30.5 cm)	38 x 54.5 x 12 in. (96.5 x 138.4 x 30.5 cm)
	Cargo Box Capacity	1,000 lb (454 kg) / California only: 600 lb (272.2 kg)	700 lb (318 kg) / California only: 600 lb (272.2 kg)	700 lb (318 kg) / California only: 600 lb (272.2 kg)
	Power Tilt Bed	N/A	N/A	N/A
	Tailgate Load Capacity	250 lb (113.4 kg)	250 lb (113.4 kg)	250 lb (113.4 kg)
	Storage Capacity	Weather resistant above gage glove box including protected cellphone area and USB-A plug Weather resistant passenger glove box with USB-C, USB-A & DC outlet Cubby storage and lower dash storage 3.7 gal (14 L) removable bin	Weather resistant above gage glove box including protected cellphone area and USB-A plug Weather resistant passenger glove box with USB-C, USB-A & DC outlet Cubby storage and lower dash storage 3.7 gal (14 L) removable bin	Weather resistant above gage glove box including protected cellphone area and USB-A plug Weather resistant passenger glove box with USB-C, USB-A & DC outlet Cubby storage and lower dash storage 3.7 gal (14 L) removable bin
	Towing Capacity	2,500 lb (1,134 kg)	2,500 lb (1,134 kg)	2,500 lb (1,134 kg)
	Payload Capacity	1,445 lb (655 kg)	890 lb (404 kg)	1,000 lb (454 kg)
	Fuel Capacity	11.9 gal (45 L)	11.9 gal (45 L)	11.9 gal (45 L)
	Person Capacity	6	6	6
FEATURES	Gauge	4.5 in. wide digital display with keypad & 10.25 in. touchscreen display	4.5 in. wide digital display with keypad & 10.25 in. touchscreen display	4.5 in. wide digital display with keypad & 10.25 in. touchscreen display
	Battery	400 CCA (32 amp/h) 12 V (cargo outlet)	400 CCA (32 amp/h) 12 V (cargo outlet)	400 CCA (32 amp/h) 12 V (cargo outlet)
	Magneto	650 W	1,700 W	1,700 W
	Instrumentation	USB outlets Lighter DC outlet Cargo 12V Outlet	USB outlets Lighter DC outlet Cargo 12V Outlet	USB outlets Lighter DC outlet Cargo 12V Outlet
	Anti-theft System	RF Digitally Encoded Security System (D.E.S.S.™) with Start/Stop button	RF Digitally Encoded Security System (D.E.S.S.™) with Start/Stop button	RF Digitally Encoded Security System (D.E.S.S.™) with Start/Stop button
	Lighting	LED headlights LED taillights with back up light LED signature	LED headlights LED taillights with back up light LED signature	LED headlights LED taillights with back up light LED signature
	Winch	4,500 lb (2,041 kg) winch with synthetic cable and autostop	4,500 lb (2,041 kg) winch with synthetic cable and autostop	4,500 lb (2,041 kg) winch with synthetic cable and autostop
	Seat	Adjustable driver's seat 40/20/40 bolster	Adjustable driver's seat 40/20/40 bolster	Adjustable driver's seat 40/20/40 bolster
	Steering Wheel	Premium steering wheel with keypad Adjustable steering wheel with full tilt-up feature	Premium steering wheel with keypad Adjustable steering wheel with full tilt-up feature	Premium steering wheel with keypad Adjustable steering wheel with full tilt-up feature
	Protection	Full heavy-duty HMW plastic skid plate Steel rock sliders Full hard roof Large heavy-duty front bumper Mudguards Door safety net	Full glass tilt up windshield with wiper kit Full color match front doors with locks and electric opening tinted windows Rear color match doors with roll down window Rear tinted glass window Panoramic mirror Full heavy-duty HMW plastic skid plate Steel rock sliders Large heavy-duty front bumper Mudguards Floor mats	Full glass tilt up windshield with wiper kit Full color match front doors with locks and electric opening tinted windows Rear color match doors with roll down window Rear tinted glass window Panoramic mirror Full heavy-duty HMW plastic skid plate Full hard roof with liner and dome light Large heavy-duty front bumper Mudguards Floor mats
	Hitch Type	2 in. hitch receiver	2 in. hitch receiver	2 in. hitch receiver

† Visco-Lok is a trademark of GKN Viscodrives GmbH.

\* Smart-Lok was developed in conjunction with TEAM Industries, a market leader in the drive train industry.

\*\*\* 1-year BRP limited warranty. B.E.S.T. term available up to 30 months.

# BUNDLE UP TO GET IT ALL DONE. YOUR DEFENDER G2 BUNDLES.

<b>ESSENTIALS</b>	Defender X mr	Rear Bumper	715009158
	Defender X mr with Half Doors	Fender Flares	715009177
	Defender XT	LinQ Lite Device Holder	715009201
	Defender XT CAB	LinQ Cargo Bed Tool Box	715009165
	Defender Limited	Side Mirrors	715008100
	Defender MAX X mr with Half Doors	Center Underseat Storage Bin (7 L)	715009199
	Defender MAX XT	Large Heavy-Duty Front Bumper	715009164
	Defender MAX XT CAB	SMART 10" (25 cm) LED Light Bar	715008745
	Defender MAX Lone Star	Lights Wiring Harness	715009886
	Defender MAX Lone Star CAB	Panoramic Center Mirror	715003638
	Defender MAX Limited	Headache Rack	715009171
		Bed Wall Extender – High (for Headache Rack)	715009590
	<b>RANCHER</b>	Defender XT	LinQ Gear Grips
Defender XT CAB		Foldable Tailgate Extension	715009179
Defender Limited		SMART 10" (25 cm) LED Light Bar	715008745
Defender MAX X mr with Half Doors		Large Heavy-Duty Front Bumper	715009164
Defender MAX XT		Accessory Control Module	715009121
Defender MAX XT CAB		SMART LED Hood Light	715009299
Defender MAX Lone Star		Cargo Rack Multi-position	715009148
Defender MAX Lone Star CAB		Cargo Rack Mounting Kit for Bed Wall Extender	715010078
Defender MAX Limited		Rear LED Light	715008236
		Can-Am ProMount Push Frame with Quick-Attach System	715008888
		Can-Am ProMount Plow Angling System	715009133
<b>WINTER</b>	Defender XT CAB	Can-Am ProMount Steel 72 in. (183 cm) Blade	715009877
	Defender Limited	Plow Limit Switch	715009894
	Defender MAX XT CAB	Apache XC LT Mounting Kit	715009252
	Defender MAX Lone Star CAB	Apache XC LT	715007719
	Defender MAX Limited	Push Frame Extension Can-Am	715009461
		Track DPS Module	715006266
		Accessory Control Module	715009121
		SMART 40" (102 cm) LED Light Bar	715008747
<b>JAMMIN IN THE TRAIL</b>	Defender X mr	SMART LED Hood Light	715009299
	Defender X mr with Half Doors	LED Light Bar Mounts	715009261
	Defender XT	Can-Am JL Audio System – Level 3	715009197
	Defender XT CAB	Can-Am JL Audio Source Unit	715010002
	Defender MAX X mr with Half Doors	Accessory Control Module	715009121
	Defender MAX XT	SMART 40" (102 cm) LED Light Bar	715008747
	Defender MAX XT CAB	SMART LED Hood Light	715009299
		LED Light Bar Mounts	715009261
		Can-Am JL Audio Subwoofer & Amplifier Kit	715008094

# ROOFS

<b>Sport Roof</b>	G1, G2	<b>715002430</b>	<b>\$549.99</b>
	G1 MAX, G2 MAX	<b>715003038</b>	<b>\$889.99</b>



- Robust injection-molded polypropylene construction.
- Provides added protection for rider and passenger from the elements.

<b>Deluxe Sport Roof</b>	G1	<b>715002511</b>	<b>\$1,188.46</b>
	G1 MAX	<b>715003039</b>	<b>\$1,802.46</b>
	G2	<b>715010883 NEW</b>	N/A
	G2 MAX	<b>715010884 NEW</b>	N/A



- Complete roof kit provides extra driver and passenger protection and also diminishes noise within the cab.
- Perfect fit and finish thanks to the seal kit and the liners included.
- Rear Roof Liner is not compatible with Soft Rear Panel.

- Includes
- Sport Roof
  - Sport Roof Seal Kit
  - Front Roof Liner
  - Rear Roof Liner

<b>Sport Roof Seal Kit</b> <i>(Not illustrated)</i>	G1, G2	<b>715003126</b>	<b>\$41.99</b>
	G1 MAX, G2 MAX	<b>715003583</b>	<b>\$39.99</b>

- Necessary when installing individual cab components with Sport Roof or when installing the Front and Rear Roof Liners.

<b>Bimini Roof with Sun Visor</b>	G1 MAX, G2 MAX	■ <b>715003030</b> • Black	<b>\$638.49</b>
-----------------------------------	----------------	----------------------------	-----------------



- Heavy-duty canvas made of UV-resistant polyester.
- Soft top comes with a hard visor that allows for storage of rolled-up soft top and mounting of Light Rack.
- Quick and easy installation.

<b>NEW Front Roof Liner</b>	G2, G2 MAX	<b>715009196</b>	<b>\$212.99</b>
-----------------------------	------------	------------------	-----------------



- Vehicle enhancement.
- Integrates seamlessly with roof-mounted light switch.
- Required for installation of roof-mounted lights.
- Allows a better integration of Windshield Wiper and Washer Kit.
- Seal Kit necessary when installing with Sport Roof.

<b>Front Roof Liner</b>	G1, G1 MAX	<b>715008226</b>	<b>\$276.49</b>
-------------------------	------------	------------------	-----------------



- Vehicle enhancement.
- Integrates seamlessly with roof-mounted light switch.
- Required for installation of roof-mounted lights and audio systems.
- Allows a better integration of Windshield Wiper and Washer Kit.
- Seal Kit necessary when installing with Sport Roof.

<b>Rear Roof Liner</b>	G1, G2†	<b>715006334</b>	<b>\$319.99</b>
	G1 MAX, G2 MAX‡ (Not illustrated)	<b>715006391</b>	<b>\$595.99</b>



- Quick and easy vehicle enhancement.
- Allows better integration of other accessories installed on the roof.
- Seal Kit necessary when installing with Sport Roof.
- Not compatible with: 715002920, 715006680, 715003249, 715002852.

†Needs to be installed with Sport Roof (715002430).  
‡Needs to be installed with Sport Roof (715003038).

## HARD CABS

### NEW Clear Rigid Cab

G2	<b>715010068</b>	<b>\$5,697.49</b>
G2 MAX	<b>715010069</b>	<b>\$9,943.74</b>



- Includes:
- Front Clear Rigid Doors (715010067).
  - Rear Clear Rigid Doors (MAX models only) (715006262).
  - Sport Roof (715002430).
  - Sport Roof Max (MAX models only) (715003038).
  - Glass Windshield (715001303).
  - Rear Polycarbonate Window (715002922).

### Clear Rigid Cab

G1 (except X mr models)	<b>715007269</b>	<b>\$5,589.99</b>
G1 MAX 2022 & up (except X mr models)	<b>715007270</b>	<b>\$9,889.99</b>



- Includes:
- Front Clear Rigid Doors (715006261).
  - Rear Clear Rigid Doors (715006262) (MAX models only).
  - Sport Roof (715002430).
  - Sport Roof Max (715003038) (MAX models only)
  - Flip Glass Windshield (715002942).
  - Rear Polycarbonate Window (715007081).
  - Sport Roof Seal Kit (715003126).

### NEW Deluxe Cab Enclosure

G2 (except X mr models)	<b>715010063</b>	<b>\$8,099.99</b>
G2 MAX (except X mr models)	<b>715010064</b>	<b>\$12,419.99</b>



- Provides driver and passenger with the best protection from the elements and the cold, and features the most complete top-of-the-line accessories our product lineup has to offer.
  - Key locking door latches.
- Includes:
- Deluxe Sport Roof Kit (715003038 or 715002430).
  - Flip Glass Windshield With SMART Intermittent Wiper & Washer Kit (715009890).
  - Front and Rear Deluxe Full Doors with Key Locking Door Latches (715010568 & 715010569).
  - Rear Glass Window (715007079).
  - Wiper and Powered Windows Cable (715009756).
  - Wire Cover Kit and Roof Power Cable (715010489).
  - Color Panels are required (sold separately).

### Deluxe Cab Enclosure

G1 (except X mr models)	<b>715010938</b>	<b>\$7,743.59</b>
G1 MAX (except X mr models)	<b>715010939</b>	<b>\$11,933.99</b>



- Provides driver and passenger with the best protection from the elements and the cold, and features the most complete top-of-the-line accessories our product lineup has to offer.
- Includes:
- Deluxe Sport Roof Kit.
  - Flip Glass Windshield with Wiper and Washer Kit.
  - Front Deluxe Full Doors with Key Locking Door Latches.
  - Rear Glass Window.
  - Wiper and Powered Windows Cable.
  - Roof Power Cable.
  - Color Panels required (sold separately).

## HYBRID CABS

### NEW Hybrid Cab Enclosure

G2 (except X mr models)	<b>715011103</b>	<b>\$2,737.04</b>
G2 MAX (except X mr models)	<b>715011104</b>	<b>\$4,259.99</b>



- Offers good protection from the elements for driver and passenger.
- Includes:
- Sport Roof.
  - Full Windshield - Hardcoated.
  - Soft Doors.
  - Rear Polycarbonate Window.

## Hybrid Cab Enclosure



Included:

- Sport Roof
- Full Hardcoated Windshield
- Soft Doors
- Rear Polycarbonate Window

G1 (all model years) (except X mr models)	<b>715008063</b>	<b>\$2,630.49</b>
G1 MAX 2018 & prior, G1 MAX 2022 & up (models produced after January 18, 2021) (except X mr models)	<b>715008064</b>	<b>\$4,054.99</b>

## G1 CAB KITS – REFERENCE CHART

	Deluxe Cab Enclosure	Deluxe Cab Enclosure MAX	Clear Rigid Cab	Clear Rigid Cab MAX	Hybrid Cab Enclosure	Hybrid Cab Enclosure MAX
Kit	<b>715010938</b>	<b>715010939</b>	<b>715007269</b>	<b>715007270</b>	<b>715008063</b>	<b>715008064</b>
Windshield	<b>715002441</b>	<b>715002441</b>	<b>715002942</b>	<b>715002942</b>	<b>715002432</b>	<b>715002432</b>
Rear Window	<b>715007079</b>	<b>715007079</b>	<b>715007081</b>	<b>715007081</b>	<b>715007081</b>	<b>715007081</b>
Roof	<b>715002430</b>	<b>715003038</b>	<b>715002430</b>	<b>715003038</b>	<b>715002430</b>	<b>715003038</b>
Front Doors	<b>715009906</b>	<b>715009906</b>	<b>715006261</b>	<b>715006261</b>	<b>715008059</b>	<b>715008059</b>
Rear Doors	-	<b>715009907</b>	-	<b>715006262</b>	-	<b>715006318</b>
Others	<b>710004462</b> <b>715003094</b> <b>715003126</b> <b>715008226</b> <b>715006334</b>	<b>710004462</b> <b>715003094</b> <b>715003583</b> <b>715008226</b> <b>715006391</b>	<b>715003126</b>	<b>715003583</b>	-	-

## G2 CAB KITS – REFERENCE CHART

	Deluxe Cab Enclosure	Deluxe Cab Enclosure MAX	Clear Rigid Cab	Clear Rigid Cab MAX	Hybrid Cab Enclosure	Hybrid Cab Enclosure MAX
Kit	<b>715010063</b>	<b>715010064</b>	<b>715010068</b>	<b>715010069</b>	<b>715011103</b>	<b>715011104</b>
Windshield	<b>715009890</b>	<b>715009890</b>	<b>715009225</b>	<b>715009225</b>	<b>715002432</b>	<b>715002432</b>
Rear Window	<b>715007079</b>	<b>715007079</b>	<b>715009325</b>	<b>715009325</b>	<b>715009325</b>	<b>715009325</b>
Roof	<b>715002430</b>	<b>715003038</b>	<b>715002430</b>	<b>715003038</b>	<b>715002430</b>	<b>715003038</b>
Front Doors	<b>715010568</b>	<b>715010568</b>	<b>715010067</b>	<b>715010067</b>	<b>715009895</b>	<b>715009895</b>
Rear Doors	-	<b>715010569</b>	-	<b>715006262</b>	-	<b>715009896</b>
Others	<b>715003126</b> <b>715009196</b> <b>715006334</b> <b>715010489</b> <b>715009756</b>	<b>715003583</b> <b>751009196</b> <b>715006391</b> <b>715010489</b> <b>715009756</b>	<b>715003126</b>	<b>715003583</b>	-	-

## NEW Floor Mats







- These durable floor mats are custom-made using 6.4 mm-thick, pre-molded rubber.
- The kit includes all the pieces to cover the entire vehicle floor.
- They're constructed with a non-slip texture that provides an excellent grip to keep your feet firmly in place.
- They help cut down on noise.
- Easily washable.

G2	<b>715008754</b>	<b>\$292.86</b>
G2 MAX	<b>715010588</b>	<b>\$553.79</b>

# WINDSHIELDS & MIRRORS



## WINDSHIELDS

<b>Powerflip Windshield</b>	G1, G1 MAX	<b>715003885</b>	<b>\$1,099.99</b>
	<ul style="list-style-type: none"> <li>The PowerFlip Windshield is equipped with electric cylinders that allow the rider to adjust the windshield opening at the touch of a button.</li> <li>Windshield is made of hardcoated polycarbonate with a rubber seal contour and a tinted top section.</li> <li>Allows you to quickly adapt to changing conditions by adjusting the windshield as you go.</li> <li>Can be fully opened for optimal visibility and ventilation, fully closed for maximum protection from the elements, and in between, you have an infinite number of opening possibilities depending on protection, visibility and air flow preferences.</li> <li>Compatible with Can-Am roofs and windshield wiper and washer kit.</li> </ul>		
<b>Flip Glass Windshield</b>	G1, G1 MAX G2, G2 MAX	<b>715002942</b> <b>715009225 NEW</b>	<b>\$1,499.99</b> <b>\$1,299.99</b>
	<ul style="list-style-type: none"> <li>Its enhanced handle allows for quick, low-effort opening (715009225 only).</li> <li>Curved and laminated glass full windshield in metal frame.</li> <li>Provides excellent optical clarity.</li> <li>Seals firmly against the cage and protects rider and passenger from the elements while allowing for controlled air flow.</li> <li>3-position flip can be set at fully closed, ¼ open, or fully open.</li> <li>Gas-shock-assisted operation and pivots on 2 hinges located at the top of the windshield.</li> <li>Ideal for muddy conditions.</li> <li>Can be used with Windshield Wiper &amp; Washer Kit (715001638 Defender G1 or 715009441 Defender G2).</li> </ul>		
<b>NEW Flip Glass Windshield with SMART Intermittent Wiper &amp; Washer Kit</b>	G2, G2 MAX	<b>715009890</b>	<b>\$1,799.99</b>
	<ul style="list-style-type: none"> <li>Its enhanced handle allows for quick, low-effort opening.</li> <li>Curved and laminated glass full windshield in metal frame.</li> <li>Provides excellent optical clarity.</li> <li>Seals firmly against the cage and protects rider and passenger from the elements while allowing for controlled airflow.</li> <li>3-position flip can be set at fully closed, ¼ open, or fully open.</li> <li>Ideal for muddy conditions.</li> <li>Gas-shock-assisted operation and pivots on 2 hinges located at the top of the windshield.</li> <li>Includes single-speed wiper, washer fluid dispenser and windshields frame mount.</li> <li>Intermittent wiper speed feature available when the kit is installed in combination with ACM and automatic speed variation mode that varies with vehicle speed.</li> <li>Requires Wiper and Power Cables when ACM is not installed:               <ul style="list-style-type: none"> <li>If equipped with the Sport Roof, Power Cables (715010489 &amp; 715009756) are required.</li> <li>If equipped with the Audio Roof, Power Cable (715010324) is required.</li> </ul> </li> </ul>		
<b>Flip Glass Windshield with Wiper &amp; Washer Kit</b>	G1, G1 MAX	<b>715002441</b>	<b>\$2,099.99</b>
	<ul style="list-style-type: none"> <li>Curved and laminated glass full windshield in metal frame.</li> <li>Provides excellent optical clarity.</li> <li>Seals firmly against the cage and protects rider and passenger from the elements while allowing for controlled airflow.</li> <li>3-position flip can be set at fully closed, ¼ open, or fully open.</li> <li>Ideal for muddy conditions.</li> <li>Gas-shock-assisted operation and pivots on 2 hinges located at the top of the windshield.</li> <li>Single-speed wiper with washer fluid dispenser.</li> <li>Requires Wiper and Power Cables: If equipped with the Sport Roof, Power Cables 710004462 &amp; 715003094 are required. If equipped with the Audio Roof, Power Cables 715008781 &amp; 715003094 are required.</li> </ul>		
<b>NEW Flip Windshield – Hardcoated</b>	G1, G1 MAX G2, G2 MAX	<b>715002442</b> <b>715010010</b>	<b>\$1,099.99</b> <b>\$999.99</b>
	<ul style="list-style-type: none"> <li>Its enhanced handle allows for quick, low-effort opening (715010010 only).</li> <li>High-impact-resistant Makrolon<sup>1</sup> hardcoated polycarbonate full windshield in metal frame.</li> <li>Provides excellent optical clarity and better abrasion resistance.</li> <li>Seals firmly against the cage and protects rider and passenger from the elements while allowing for controlled airflow.</li> <li>3-position flip can be set at fully closed, ¼ open, or fully open.</li> <li>Gas-shock-assisted operation.</li> <li>Ideal for muddy conditions.</li> </ul>		

<b>NEW Glass Windshield</b>	G1, G1 MAX	<b>715001303</b>	<b>\$1,119.99</b>
	G2, G2 MAX	<b>715010876</b>	<b>\$1,049.99</b>



- Curved and laminated glass full windshield in metal frame.
- Seals firmly against the cage and protects rider and passenger from the elements while providing excellent optical clarity.
- Must be used with Windshield Wiper & Washer Kit (715001638 Defender G1 or 715009441 Defender G2) to maintain clear visibility during severe riding conditions.

<b>Full Windshield – Hardcoated</b>	G1, G1 MAX, G2, G2 MAX	<b>715002432</b>	<b>\$659.99</b>
-------------------------------------	------------------------	------------------	-----------------



- High-impact-resistant Makrolon<sup>1</sup> hardcoated polycarbonate full windshield.
- Provides excellent optical clarity and better abrasion resistance.
- Protects driver and passenger from the elements.
- Quick and easy tool-less installation or removal.

<b>Full Windshield</b>	G1, G1 MAX	<b>715002431</b>	<b>\$439.99</b>
------------------------	------------	------------------	-----------------



- High-impact-resistant durable polycarbonate full windshield.
- Formulated to be non-yellowing, non-crazing, non-cracking with excellent UV resistance and optical clarity.
- Protects driver and passenger from the elements.
- Quick and easy tool-less installation or removal.

<b>NEW Half Windshield – Hardcoated</b>	G1, G1 MAX, G2, G2 MAX	<b>715010075</b>	<b>\$399.99</b>
---	------------------------	------------------	-----------------



- High-impact-resistant Makrolon<sup>1</sup> hardcoated polycarbonate half windshield.
- Formulated to be non-yellowing, non-crazing, non-cracking with excellent UV resistance and optical clarity.
- Protects driver and passenger from the elements.
- Features reverse angle lip to deflect air flow.
- Quick and easy tool-less installation or removal.
- Not compatible with Soft Doors.

<b>ProVent Windshield</b>	G1, G1 MAX, G2, G2 MAX	<b>715005276</b>	<b>\$909.99</b>
---------------------------	------------------------	------------------	-----------------



- High-impact-resistant Quantum hardcoated polycarbonate full windshield.
- Optimal performance with Full Cab Enclosure.
- Controllable vents to manage air flow.
- Channels air into the cabin, defogs windshield, fully closes to eliminate air flow.
- 2 lower vents and one upper vent (pre-filter installed).
- Provides excellent optical clarity and better abrasion resistance.
- Protects driver and passenger from the elements.
- Quick and easy tool-less installation or removal.
- Not compatible with wiper kits.

<b>NEW SMART Intermittent Wiper &amp; Washer Kit</b>	G2, G2 MAX	<b>715009441</b>	<b>\$719.99</b>
--	------------	------------------	-----------------



- An ideal way to keep your windshield clear in rain, or while riding through mud and water.
- Includes single-speed wiper, washer fluid dispenser and windshields frame mount.
- Automatic speed variation mode and intermittent wiper speed features available when the kit is installed in combination with ACM and that varies with vehicle speed.
- Must be used with the Glass Windshield (715010876) or Flip Glass Windshield (715009225).
- Requires Wiper and Power Cables when ACM is not installed:
  - If equipped with the Sport Roof, Power Cables (715010489 & 715009756) are required.
  - If equipped with the Audio Roof, Power Cable (715010324) is required.
- Included with Flip Glass Windshield with SMART Intermittent Wiper & Washer Kit (715009890).

<b>Windshield Wiper &amp; Washer Kit</b>	G1, G1 MAX	<b>715001638</b>	<b>\$719.99</b>
--	------------	------------------	-----------------



- An ideal way to keep your windshield clear in rain, or while riding through mud and water.
- Includes single-speed wiper, washer fluid dispenser and windshields frame mount.
- Must be used with the Glass Windshield (715010876) or Flip Glass Windshield (715002942) or Powerflip Windshield (715003885).
- Requires Wiper and Power Cables: If equipped with the Sport Roof, Power Cables 710004462 & 715003094 are required. If equipped with the Audio Roof, Power Cables 715008781 & 715003094 are required.

<b>NEW Wiper &amp; Power Windows Cable</b>	G2, G2 MAX	<b>715009756</b>	<b>\$128.39</b>
--	------------	------------------	-----------------



- Required to install Front Deluxe Full Doors (715010568 or 715010570) and/or Intermittent Wiper & Washer Kit (715009441).
- Necessary if you want to build your own cab enclosure from modular components.
- Not compatible with Audio Roof.

<b>NEW Wiper &amp; Power Windows Cable</b>	G2, G2 MAX	<b>715010324</b>	<b>\$139.09</b>
--	------------	------------------	-----------------



- Required to install Front Deluxe Full Doors (715010568 or 715010570) and/or Intermittent Wiper & Washer Kit (715009441) with the Audio Roof.
- Necessary if you want to build your own cab enclosure from modular components.

<b>Wiper &amp; Power Windows Cable</b> <i>(Not illustrated)</i>	G1, G1 MAX	<b>715008781</b>	<b>\$80.99</b>
--	------------	------------------	----------------

- Required to install the Audio Roof (715005206 or 715006879) with the following accessories: Flip Glass Windshield with Wiper & Washer Kit (715002441), Windshield Wiper & Washer Kit (715001638) and Front Deluxe Full Doors (715009906 or 715009913).

<b>Wiper &amp; Power Windows Cable</b> <i>(Not illustrated)</i>	G1, G1 MAX	<b>710004462</b>	<b>\$80.99</b>
--	------------	------------------	----------------

- Required to install Front Deluxe Full Doors (715009906 or 715009913) and/or Windshield Wiper & Washer Kit (715001638).
- Necessary if you want to build your own cab enclosure from modular components.

<b>Manual Wiper Kit</b>	G1, G1 MAX, G2, G2 MAX	<b>715008755</b>	<b>\$127.99</b>
-------------------------	------------------------	------------------	-----------------



- Single manual wiper that can be used to clear windshield of debris.
- Easy to install system that requires no electrical hookup.
- Large ergonomic handle provides a good grip over the entire sweeping surface.
- Compatible with glass and hardcoated windshields that use top mounted wipers.

<b>Side Wind Deflectors</b>	G1, G1 MAX, G2, G2 MAX	<b>715005081</b>	<b>\$234.49</b>
-----------------------------	------------------------	------------------	-----------------



- Clear polycarbonate air deflectors mount on each side of the cage.
- Not compatible with Full Doors.
- Sold in pairs.
- Compatible with all windshields.
- Can be adjusted at three different positions for cabin air flow control when a full windshield is installed:
  1. Outside deflection to reduce cabin air flow and turbulence.
  2. Inside deflection to increase air flow in the cabin.
  3. Windshield ventilation to reduce fog.

## MIRRORS

<b>Side Mirrors</b>	G1, G1 MAX, G2, G2 MAX	■ <b>715008100</b> - Black	<b>\$234.49</b>
---------------------	------------------------	----------------------------	-----------------



- Rugged black nylon 6/6 construction with coated cast-aluminum mount.
- Dual adjustment (horizontal and vertical) will suit any rider.
- Convex optics deliver optimal field of view (FOV).
- Spring-loaded pivots let mirrors fold back completely.
- Fit with and without doors and half doors.
- Sold in pairs.
- Not compatible with Soft Doors and Soft Cab Enclosures.

<b>Side Mirror</b>	G1, G1 MAX (2022 & up), G2, G2 MAX	<b>715008101*</b>	<b>\$148.99</b>
	G1, G1 MAX (2021 & prior)	<b>715002459</b>	<b>\$127.99</b>



- Molded heavy-duty aluminum mirror.
  - Stays in place on rough trails.
  - Ball-joint design for steady multi-angle adjustment and outstanding vision.
  - Use with or without any roof, windshield or doors.
  - Not for road use.
  - Fits either side.
  - Sold individually.
- \*Not compatible with the Half Doors (715006314 & 715006316).*

<b>Panoramic Center Mirror</b>	G1, G1 MAX, G2, G2 MAX	<b>715003638</b>	<b>\$104.99</b>
--------------------------------	------------------------	------------------	-----------------



- Wide-angle convex mirror.
- Offers enhanced visibility.
- Can be used with or without roof or windshield and with cab enclosures.

# REAR WIND PROTECTION

<b>Rear Glass Window with Sliding Panel</b>	G1, G1 MAX (except X mr models), G2, G2 MAX	<b>715007080</b>	<b>\$929.99</b>
---	--	------------------	-----------------



- Made of high-strength tempered glass.
- Ideal for preventing backdraft of dust or rain in harsh environments.
- Sliding panel for enhanced ventilation.
- Quick and easy installation.
- Sport Roof (715002430 or 715003038) required for installation.
- Not compatible with Snorkel Kit.

<b>Rear Glass Window</b>	G1, G1 MAX (except X mr models), G2, G2 MAX	<input checked="" type="checkbox"/> <b>715009915</b> • Tinted	<b>\$669.99</b>
		<input type="checkbox"/> <b>715007079</b> • Clear	<b>\$609.99</b>



- Made of high-strength tempered glass.
- Ideal for preventing backdraft of dust or rain in harsh environments.
- Quick and easy installation.
- Sport Roof (715002430 or 715003038) required for installation.
- Not compatible with Snorkel Kit.
- Tinted glass 14% VLT (visual light transmission).
- Rear Wind Protection Installation Seal Kit (715006705) required for installation on 2020 Defender models.

<b>Rear Polycarbonate Window</b>	G1, G1 MAX (except X mr models)	<b>715007081</b>	<b>\$479.99</b>
	G2, G2 MAX	<b>715009325</b>	<b>\$479.99</b>



- High-impact-resistant polycarbonate window.
- Ideal for preventing backdraft of dust or rain in harsh environments.
- Quick and easy installation.
- Sport Roof (715002430 or 715003038) required for installation.

<b>Rear Wind Screen</b>	G1, G1 MAX, G2, G2 MAX	<b>715002851</b>	<b>\$138.49</b>
-------------------------	------------------------	------------------	-----------------



- Full rear mesh screen reduces windshield backdraft for added cabin comfort.
- Installs quickly and easily on roll cage.
- White Can-Am logo at top, to help maintain clear view.

<b>Soft Rear Window</b>	G1, G1 MAX, G2, G2 MAX	<b>715003249</b>	<b>\$148.99</b>
-------------------------	------------------------	------------------	-----------------



- Clear, flexible window made of see-through vinyl.
- Resists cold cracking to -4°F (-20°C).
- Blocks windshield backdraft or dust and rain from entering, for added cabin comfort.
- Installs quickly and easily on roll cage.
- White Can-Am logo at top, to help maintain clear view.

# DOORS

## NEW Front Deluxe Full Doors



G2 (except X mr models),  
G2 MAX (except X mr models)

715010568 • Clear

\$4,119.99

715010570 • Tinted

\$4,279.99

- Premium doors made from robust polyethylene.
- Offer excellent protection from the elements.
- Key locking door latches.
- Tinted glass 14% VLT (visual light transmission).
- Easy to remove on hot and sunny days.
- Convenient integrated storage areas.
- Doors' curved design provides even more room.
- Rear-hinge wide opening for ease of ingress/egress in the cockpit.
- Power window delivers added ventilation.
- Compatible with all BRP windshields.
- Requires for installation:
  - Wiper and Doors Wiring Harness (715009756) for Sport Roof or the Wiper and Doors Harness (715010324) for Audio Roof.
  - Cable Cover and Roof Power Cable Kit (715010489).
  - Front Roof Liner (715009196) and Sport Roof Seal Kit (715003126).
  - Color Door Trims are required (sold separately).
- Hardware to install the Door Trims is included.

## Front Deluxe Full Doors



G1 (except X mr models),  
G1 MAX (except X mr models)

715009906 • Clear

\$4,119.99

715009913 • Tinted

\$4,279.99

- New key locking door latches.
- Premium doors made from robust polyethylene.
- Offer excellent protection from the elements.
- Tinted glass 55% VLT (visual light transmission).
- Easy to remove on hot and sunny days.
- Convenient integrated storage areas.
- Doors' curved design provides even more room.
- Rear-hinge wide opening for ease of ingress/egress in the cockpit.
- Power window delivers added ventilation.
- Compatible with all BRP windshields.
- Require Wiper & Power Windows Cable (710004462), Roof Power Cable (715003094), Sport Roof Seal Kit (715003126).
- If equipped with the Audio Roof, the Wiper & Power Windows Cable (715008781) is required.
- Color Door Trims are required (sold separately).
- Hardware to install the Door Trim is included.

## NEW Rear Deluxe Full Doors



G2 MAX

715010569 • Clear

\$3,839.99

715010571 • Tinted

\$4,069.99

- New key locking door latches.
- Premium doors made from robust polyethylene.
- Offer excellent protection from the elements.
- Tinted glass 14% VLT (visual light transmission).
- Easy to remove on hot and sunny days.
- Convenient integrated storage areas.
- Doors' curved design provides even more room.
- Rear-hinge wide opening for ease of ingress/egress in the cockpit.
- Roll-Down Window delivers added ventilation.
- Require Front Doors (715010568) or Front Deluxe Full Doors – Tinted Glass (715010570), Wiper and Doors Wiring Harness (715009756) for Sport Roof or the Wiper and Doors Harness (715010324) for Audio Roof.
- Cable Cover and Roof Power Cable Kit (715010489).
- Front Roof Liner (715009196) and Sport Roof Seal Kit (715003126).
- Color Door Trims are required (sold separately).
- Hardware to install the Door Trim is included.

## Rear Deluxe Full Doors



G1 MAX 2022 & up (models produced after  
January 18, 2021) (except X mr models)

715009907 • Clear

\$3,839.99

715009914 • Tinted

\$4,069.99

- New key locking door latches.
- Premium doors made from robust polyethylene.
- Offer excellent protection from the elements.
- Tinted glass 14% VLT (visual light transmission).
- Easy to remove on hot and sunny days.
- Convenient integrated storage areas.
- Doors' curved design provides even more room.
- Rear-hinge wide opening for ease of ingress/egress in the cockpit.
- Roll-Down Window delivers added ventilation.
- Require Front Deluxe Full Doors (715009906 or 715009913), Wiper & Power Windows Cable (710004462), Roof Power Cable (715003094), Sport Roof Seal Kit (715003583 for MAX vehicle).
- Color Door Trims are required (sold separately).
- Hardware to install the Door Trim is included.

## Front Deluxe Half Doors



G2, G2 MAX  
G1, G1 MAX (2022 & up)

715010572 **NEW**

\$2,489.99

715007201

\$2,489.99

- Premium color matching doors made from robust polyethylene.
- Premium fit and finish.
- Slim with interior pockets.
- Rear hinge wide opening for ease of ingress/egress in the cockpit.
- Interior and exterior handles.
- Color accent panels are required (sold separately).
- Hardware to install the Door Trim is included.

<b>Rear Deluxe Half Doors</b>	G2 MAX	<b>715010573 NEW</b>	<b>\$2,489.99</b>
	G1, G1 MAX (2022 & up)	<b>715007202</b>	<b>\$2,489.99</b>



- Premium color matching doors made from robust polyethylene.
- Premium fit and finish.
- Slim with interior pockets.
- Rear hinge wide opening for ease of ingress/egress in the cockpit.
- Interior and exterior handles.
- Color accent panels are required (sold separately).
- Hardware to install the Door Trims is included.

<b>NEW Front Trims</b>	G2, G2 MAX		<b>\$267.49</b>
------------------------	------------	--	-----------------



- Customize your Defender by adding color-matched door panels.
- Front color-matched panel for full and half doors.
  - Front Deluxe Full Doors (715010568), Front Deluxe Full Doors – Tinted Glass (715010570) or Front Deluxe Half Doors (715010572) are required.

Front Left Door Trim

- **705801224** • Stealth Black **NEW**
- **705801269** • Dark Wildland Camo **NEW**
- **705801551** • Dusty Navy **NEW**

Front Right Door Trim

- **705801225** • Stealth Black **NEW**
- **705801270** • Dark Wildland Camo **NEW**
- **705801552** • Dusty Navy **NEW**

<b>NEW Rear Trims</b>	G2 MAX		<b>\$267.49</b>
-----------------------	--------	--	-----------------



- Customize your Defender by adding color-matched door panels.
- Rear color-matched panel for full and half doors.
  - Rear Deluxe Full Doors (715010569), Rear Deluxe Full Doors – Tinted Glass (715010571) or Rear Deluxe Half Doors (715010573) are required.

Rear Left Door Trim

- **705801234** • Stealth Black **NEW**
- **705801271** • Dark Wildland Camo **NEW**
- **705801275** • Dusty Navy **NEW**

Rear Right Door Trim

- **705801235** • Stealth Black **NEW**
- **705801272** • Dark Wildland Camo **NEW**
- **705801276** • Dusty Navy **NEW**

<b>Front Trims</b>	G1, G1 MAX		<b>\$274.99</b>
--------------------	------------	--	-----------------



- Customize your Defender by adding color-matched door panels.
- Front Deluxe Full Doors (715009906), Front Deluxe Full Doors – Tinted Glass (715009913) or Front Deluxe Half Doors (715007201) are required.

Front Left Door Trim

- **705801617** • Dark Wildland Camo **NEW**
- **705801565** • Dusty Navy
- **705801303** • Stealth Black
- **705801330** • Compass Green
- **705801504** • Timeless Black
- **705801340** • Fiery Red
- **705801408** • Hyper Silver

Front Right Door Trim

- **705801618** • Dark Wildland Camo **NEW**
- **705801566** • Dusty Navy
- **705801305** • Stealth Black
- **705801331** • Compass Green
- **705801505** • Timeless Black
- **705801341** • Fiery Red
- **705801409** • Hyper Silver

<b>Rear Trims</b>	G1 MAX		<b>\$274.99</b>
-------------------	--------	--	-----------------



- Customize your Defender by adding color-matched door panels.
- Rear Deluxe Full Doors (715009907), Rear Deluxe Full Doors – Tinted Glass (715009914) or Rear Deluxe Half Doors (715007202) are required.

Rear Left Door Trim

- **705801619** • Dark Wildland Camo **NEW**
- **705801567** • Dusty Navy
- **705801307** • Stealth Black
- **705801332** • Compass Green
- **705801506** • Timeless Black
- **705801342** • Fiery Red
- **705801410** • Hyper Silver

Rear Right Door Trim

- **705801620** • Dark Wildland Camo **NEW**
- **705801568** • Dusty Navy
- **705801309** • Stealth Black
- **705801333** • Compass Green
- **705801507** • Timeless Black
- **705801343** • Fiery Red
- **705801411** • Hyper Silver

<b>NEW Front Clear Rigid Doors</b>	G2, G2 MAX	<b>715010067</b>	<b>\$3,399.99</b>
------------------------------------	------------	------------------	-------------------



- Sturdy and compact steel frame doors for a robust yet open field of view.
- Lower hardcoated polycarbonate transparent panel maximizes visibility around your unit.
- Upper portion composed of two tempered-glass sliding windows for unmatched air circulation and versatility.
- EC and ROHVA-compliant for optimal safety, allowing you to remove the stock side protection bar for increased cabin space.
- Sealed contour allows for improved rider comfort in all weather.
- Lockable doors for peace of mind.

<b>Front Clear Rigid Doors</b>	G1 (all model years) (except X mr models), G1 MAX 2022 & up (except X mr models)	<b>715006261</b>	<b>\$3,349.99</b>
--------------------------------	---	------------------	-------------------



- Sturdy and compact steel-frame doors for a robust yet open field of view.
- Lower hardcoated polycarbonate transparent panel maximizes visibility around your unit.
- Upper portion composed of two tempered-glass sliding windows for unmatched air circulation and versatility.
- EC- and ROHVA-compliant for optimal safety, allowing you to remove the stock side protection bar for increased cabin space.
- Sealed contour allows for improved rider comfort in all weather.
- Lockable doors for peace of mind.

<b>Rear Clear Rigid Doors</b>	G1 MAX 2022 & up (except X mr models), G2 MAX	<b>715006262</b>	<b>\$3,349.99</b>
-------------------------------	--	------------------	-------------------



- Sturdy and compact steel-frame doors for a robust yet open field of view.
- Lower hardcoated polycarbonate transparent panel maximizes visibility around your unit.
- Upper portion composed of two tempered-glass sliding windows for unmatched air circulation and versatility.
- EC- and ROHVA-compliant for optimal safety, allowing you to remove the stock side protection bar for increased cabin space.
- Sealed contour allows for improved rider comfort in all weather.
- Lockable doors for peace of mind.

<b>Half Doors</b>	G1	<b>715006314</b> • 2 doors	<b>\$1,155.49</b>
	G1 MAX	<b>715006316</b> • 4 doors	<b>\$1,936.49</b>
	G2	<b>715010076</b> • 2 doors <b>NEW</b>	<b>\$1,155.59</b>
	G2 MAX	<b>715010077</b> • 4 doors <b>NEW</b>	<b>\$2,139.99</b>



- Half doors made of plastic.
- Metal frame for a higher level of fit and finish and rigidity.
- Rear hinge wide opening for ease of ingress/egress in the cockpit.
- Interior pockets and liners for more comfort.

<b>NEW Soft Doors Can-Am</b>	G1, G1 MAX, G2, G2 MAX	<b>715009895</b> • 2 front doors	<b>\$1,389.99</b>
	G1 MAX 2018 & prior, 2022 & up (models produced after January 18, 2021), G2 MAX	<b>715009896</b> • 2 rear doors	<b>\$1,239.99</b>



- The design has been improved to enhance functionality.
- Weather-resistant soft doors reinforced with steel frame offer good protection from the elements.
- Made of heavy-duty UV-resistant canvas for excellent resistance to tear and abrasion.
- Rear hinge wide opening for ease of ingress/egress.
- Zip-down windows made of laminated polished vinyl material for added ventilation.
- Quick and easy installation, and easily removable on hot sunny days.
- Compatible with BRP roofs and mirrors.

*Soft Door Installation Kit (715006238 / 2X for MAX) is required for installation of 2019 and prior doors on 2020 Defender models.*

<b>Front Deluxe Door Locks</b>	G1, G1 MAX	<b>715009951</b>	<b>\$259.99</b>
--------------------------------	------------	------------------	-----------------



- Allow you to upgrade your deluxe doors with integrated door locks.
- Include a pair of locks for front doors.
- Included on Deluxe Doors and Deluxe Cab Kits 2025 and over.
- 2 keys included.

<b>Front &amp; Rear Deluxe Door Locks</b>	G1 MAX	<b>715009952</b>	<b>\$469.99</b>
---	--------	------------------	-----------------



- Allow you to upgrade your deluxe doors with integrated door locks.
- Include 4 locks for front and rear doors.
- Included on Deluxe Doors and Deluxe Cab Kits 2025 and over.
- 2 keys included.

# SEAT ACCESSORIES

<b>Central Headrest</b>	G1, G1 MAX, G2, G2 MAX	<b>715005163</b>	<b>\$169.99</b>
-------------------------	------------------------	------------------	-----------------



- Headrest for front-center-seating position on 3-seated models and for rear-center-seating position on MAX models.
- Front Headrests are available separately for front passengers on MAX models.
- Headrests are required for all passengers on some regulated trails.
- Not EC compliant.

*Headrests are required for all passengers on some regulated trails.*

<b>Front Headrests</b>	G1 MAX, G2 MAX	<b>715005164</b>	<b>\$255.49</b>
------------------------	----------------	------------------	-----------------



- Additional headrest for all three front-seating positions on MAX models.
- Central Headrest is available separately for rear-center-seating positions on MAX models.
- Headrests are required for all passengers on some regulated trails.
- Not EC compliant.

*Headrests are required for all passengers on some regulated trails.*

# ALUMINUM SKID PLATES

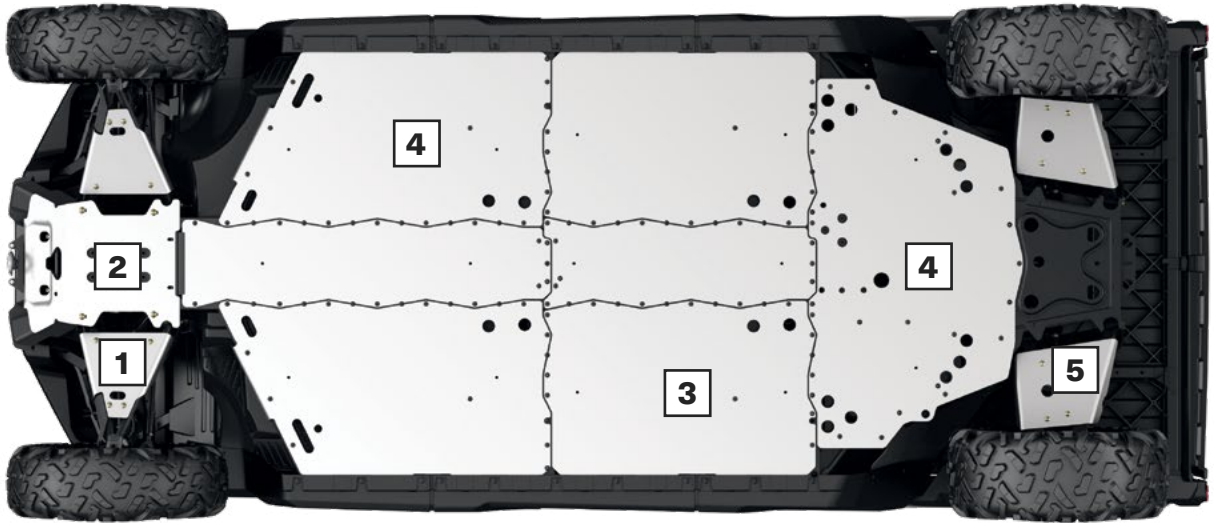

For ultimate durability and strength, all our Aluminum Skid Plates are made with High Strength 5052 H32 Aluminum  $\frac{3}{16}$ " (4.5 mm) thick.

- Ultimate durability
- High strength

## DEFENDER, DEFENDER MAX

	2019 & prior		2020 & up			2026
	Front suspension type					
	Double A-Arm (G1)	Arched double A-Arm with Swaybar (G1)	Double A-Arm (G1)	Arched double A-Arm (G1)	Arched double A-Arm with Swaybar (G1)	Arched double A-Arm with Swaybar (G2)
<b>Offer your Defender the full protection kit or get parts individually</b>						
<b>FULL PROTECTION KIT</b>						
Aluminum Skid Plate Protection Kit	715003711 (except MAX)	715006977 (3-up)	715006694 (except MAX)	715006696 (3-up & 6x6)	715006979 (3-up 2020 to 2021 only)	715009141
	715003712 (MAX only)	715006978 (MAX)	715006695 (MAX only)	715006697 (MAX & PRO)	715006980 (MAX 2020 to 2021 only)	
<b>INDIVIDUAL ALUMINUM SKID PLATES</b>						
<b>1 Front A-Arm Protectors</b>					715004387 (2022 & up)	715009404 (compatible with Apache XC LT Track System)
<ul style="list-style-type: none"> <li>• Extra underside protection for your vehicle's steering mechanism and suspension (A-arm).</li> <li>• Sold in pairs.</li> <li>• Not compatible with Apache Track Systems.</li> </ul>	715008274	715006975	715008274	715004387	715006975 (2020 to 2021 only)	
<b>2 Front Skid Plate</b>						715009137 (not compatible with plow)
<ul style="list-style-type: none"> <li>• Protects the front underside of your vehicle when riding in rough terrain conditions.</li> <li>• Adds style to the front of your vehicle.</li> </ul>	715002447	715002447	715002447	715002447	715002447	
<b>3 Central Skid Plate</b>						N/A
Central Skid Plate Kit includes central and lateral skid plates. <ul style="list-style-type: none"> <li>• Ultra-durable protection for the underside of your vehicle.</li> <li>• Makes work easy in more demanding terrain.</li> <li>• Must be used with Underbelly Skid Plate Kit.</li> </ul>	715003467 (MAX only)	715003467 (MAX only)	715003467 (MAX & PRO only)	715003467 (MAX & PRO only)	715003467 (MAX & PRO only)	
<b>4 Underbelly Skid Plate Kit</b>						N/A
<ul style="list-style-type: none"> <li>• Ultra-durable protection for the underside of your vehicle.</li> <li>• Makes work easy in more demanding terrain.</li> <li>• Kit includes central, lateral and rear skid plates.</li> </ul>	715002446	715002446	715007982	715007982	715007982	
<b>5 Rear A-Arm Protectors</b>						715009405 (compatible with Apache XC LT Track System)
<ul style="list-style-type: none"> <li>• Extra underside protection for your vehicle's suspension (A-arm).</li> <li>• Sold in pairs.</li> <li>• Not compatible with Apache Track Systems.</li> </ul>	715002445	715006976	715002445	715004388	715006976 (2020 to 2021 only)	

# BUMPERS & GUARDS

## BUMPERS

### NEW Large Heavy-Duty Front Bumper

G2, G2 MAX

715009164

\$372.74



- 1.5" (3.8 cm) diameter steel-tube construction.
- Provides heavy-duty protection.
- Inside and outside anti-corrosion coating with durable powder coat finish.
- Integrated mounting point for SMART 10" (25 cm) LED Light Bar (715008745).
- Standard on all Lone Star and Limited Cab models.

### Front Bumper

G1, G1 MAX (2019 & prior)

715002418

\$350.99

G1, G1 MAX (2020 & up)

715005754

\$351.49



- Heavy-duty 1.5" (3.8 cm) diameter steel-tube construction.
- Provides enhanced protection.
- Inside and outside anti-corrosion coating with durable powder coat finish.
- Integrated mounting points for lights.
- Required to install the Xtreme Front Bumper Plates, Front Rack and the Front Corner Protectors.

### Xtreme Front Bumper Plates

G1, G1 MAX (2019 & prior)<sup>†</sup>

715003005

\$340.49

G1, G1 MAX (2020 & up)<sup>‡</sup>

715005777

\$320.99



- Made of high-strength heavy-gauge steel with rubber pads for increased protection.
- Inside and outside anti-corrosion coating with durable powder coat finish.
- Provide additional front-end protection.

<sup>†</sup>Require Front Bumper (715002418) for installation.

<sup>‡</sup>Require Front Bumper (715005754) for installation.

### Front Corner Protectors

G1, G1 MAX (2019 & prior)<sup>†</sup>

715002833

\$244.99

G1, G1 MAX (2020 & up)<sup>‡</sup>

715005774

\$244.99



- Heavy-duty 1.25" (3.2 cm) diameter steel-tube construction.
- Provide enhanced protection for front corners.
- Inside and outside anti-corrosion coating with durable powder coat finish.
- Sold in pairs.

<sup>†</sup>Require Front Bumper (715002418) for installation.

<sup>‡</sup>Require Front Bumper (715005754) for installation.

### Rancher Front Bumper

G1, G1 MAX

715005410

\$723.99



- The low front-end protection and plates allow you to use your vehicle within cattle herds and guard the safety of both the vehicle and the animals.
- The flat front portion facilitates gently prodding cattle or pushing light objects, e.g., closing a fence.
- The full frontage coverage extends to provide an extra layer of defense to your headlights and radiator.
- Inside and outside anti-corrosion coating with durable powder coat finish.
- Improved approach angle.
- Compatible with front rack, snow plows, tire and track kits, winches.

### XT Front Bumper

G1, G1 MAX (2019 & prior)

715004407

\$212.99



- 1.5" (3.8 cm) diameter steel-tube construction.
- Provides light-duty protection.
- Inside and outside anti-corrosion coating with durable powder coat finish.
- Light-kit compatible.
- Standard on XT and XT Cab models 2018 and 2019.
- Not compatible with Xtreme Front Bumper Plates, Front Corner Protectors or LinQ® Front Rack.

### X mr Front Bumper

G1, G1 MAX

■ 715006143 • Black

\$350.99



- Heavy-duty 1.5" (3.8 cm) diameter steel-tube construction.
- Inside and outside anti-corrosion coating with durable finish.
- Provides additional front body protection.
- Integrated winch support plate for winch relocation at a higher position for easier access in muddy conditions or for auxiliary lights.
- Includes a front tow hook.
- Standard on X mr models.
- Winch sold separately.

<b>Cargo Bed Protectors &amp; Tie Rails</b>	G1 (6x6 & PRO models only)	<b>715005415</b>	<b>\$351.49</b>
---	----------------------------	------------------	-----------------

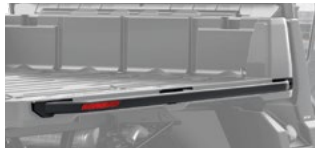

- Heavy-duty 1.5" (3.8 cm) diameter steel-tube construction.
- Reliable cargo box protection and tie-down attachment point to secure large loads.
- Anti-corrosion coating with durable powder coat finish.
- Designed to stay in place when cargo bed side walls are removed.

<b>NEW Rear Bumper</b>	G2, G2 MAX	<b>715009158</b>	<b>\$372.74</b>
------------------------	------------	------------------	-----------------



- Heavy-duty 1.5" (3.8 cm) diameter steel construction and integrated tubular design.
- Integrated lower and upper grip step for easy access to the cargo bed.
- Increased protection of rear cargo box and lower box corner while allowing normal tailgate function.
- Inside and outside anti-corrosion coating with durable powder-coat finish.

<b>Rear Bumper</b>	G1, G1 MAX	<b>715008109</b>	<b>\$319.49</b>
--------------------	------------	------------------	-----------------



- Heavy-duty 1.5" (3.8 cm) diameter steel construction and integrated tubular design.
- Increased protection of rear box and lower box corner while allowing normal tailgate function.
- Inside and outside anti-corrosion coating with durable powder-coat finish.
- Required to install Rear Body Side Protector (715003055).

<b>Rear Bumper Adapter</b> <i>(Not illustrated)</i>	G1 (6x6 & PRO models only)	<b>715006060</b>	<b>\$53.99</b>
--	----------------------------	------------------	----------------

- Required to install the Rear Bumper on Defender models with the long box.

<b>Rear Body Side Protectors</b>	G1, G1 MAX	<b>715003055</b>	<b>\$223.49</b>
----------------------------------	------------	------------------	-----------------



- Heavy-duty 1.5" (3.8 cm) diameter steel-tube construction.
- Reliable cargo box protection.
- Inside and outside anti-corrosion coating with durable powder coat finish.
- Compatible with fender flares.
- Integrated brush and low-lying branch deflector.
- Require Rear Bumper for installation.
- Sold in pairs.

## BODY SIDE PROTECTORS

<b>Front Body Side Protectors</b>	G1, G1 MAX	<b>715003450</b>	<b>\$164.99</b>
-----------------------------------	------------	------------------	-----------------



- Heavy-duty 1.25" (3.2 cm) diameter steel-tube construction.
- Front side protection for farm, ranch and forestry applications.
- Offer complete front body protection.
- Inside and outside anti-corrosion coating with durable powder coat finish.
- Sold in pairs.
- Require Front Bumper (715002418 or 715005754) with Front Corner Protectors (715002833 or 715005774) and Rock Slider (715002569 or 715003040 for MAX models) for installation.

<b>Front Rancher Body Side Protectors</b>	G1, G1 MAX	<b>715003617</b>	<b>\$209.99</b>
---	------------	------------------	-----------------



- Heavy-duty 1.25" (3.2 cm) diameter steel-tube construction.
- Front side protection for farm, ranch and forestry applications.
- Offer complete front body protection.
- Inside and outside anti-corrosion coating with durable powder coat finish.
- Sold in pairs.
- Require Rancher Bumper and Rock Sliders for installation.

## FENDER FLARES

	G1 (except 6x6 & PRO), G1 MAX	<b>715006821</b>	<b>\$287.49</b>
	G1 6x6	<b>715005409</b>	<b>\$389.99</b>
	G1 PRO	<b>715006001</b>	<b>\$340.49</b>
	G2, G2 MAX	<b>715009177</b> <b>NEW</b>	<b>\$244.94</b>

### Fender Flares



- Robust injection-molded polypropylene construction.
- Perfect for keeping mud and debris outside the vehicle.
- Include front and rear extension, and all mounting hardware.
- Ideal for track equipped vehicles.

### Sport Fender Flares

G1 (except 6x6 & PRO), G1 MAX	<b>715003898</b>	<b>\$269.99</b>
-------------------------------	------------------	-----------------



- Sleek fender flares just the right size to reduce mud and debris kick-up from your tires.
- Robust injection-molded polypropylene construction.
- Include front and rear extension, and all mounting hardware.

## ROCK SLIDERS

<b>NEW</b> X mr / Lone Star Rock Sliders	G2	<b>715009421</b>	<b>\$372.74</b>
	G2 MAX	<b>715010031</b>	<b>\$585.74</b>



- Rock sliders made of painted 2 mm steel with an integrated step for elevated cargo box access.
- Protect vehicle's sides and undercarriage against large obstacles.
- Lodge tight up against vehicle body for better clearance from obstacles.
- Standard on Defender G2 X mr and Lone Star models.
- Sold in pairs.

Rock Sliders	G1	■ <b>715006671</b> • Black	<b>\$510.99</b>
	G1 MAX, G1 PRO	■ <b>715006721</b> • Black	<b>\$745.49</b>



- Heavy-duty rock sliders made of painted 3/16" (5 mm) aluminum with an integrated step for elevated cargo box access.
- Protect vehicle's sides and undercarriage against large obstacles.
- Lodge tight up against vehicle body for better clearance from obstacles.
- Not compatible with other rock sliders.
- Sold in pairs.
- Standard on Defender X mr, Defender MAX X mr and Defender XT-P models.

Rock Sliders	G1, G1 6x6	<b>715002569</b>	<b>\$404.49</b>
	G1 MAX, G1 PRO	<b>715003040</b>	<b>\$479.49</b>



- Protect vehicle's sides and undercarriage against large obstacles.
- Made of heavy-duty 1.5" (3.8 cm) diameter steel tubing.
- Inside and outside anti-corrosion coating with durable powder coat finish.
- Integrated step for easy cargo box access.
- Sold in pairs.

## MUD FLAPS

Mud Flaps	G1, G1 MAX	<b>715003041</b>	<b>\$170.49</b>
-----------	------------	------------------	-----------------



- Keep mud and debris out of cargo area and protect trailer or vehicles behind you.
- Add aesthetic appeal to your vehicle.
- Made of EPDM rubber.
- Require Rear Bumper for installation.
- Sold in pairs.



# LINQ SYSTEM

The LinQ system offers tool-free, near-instant attachment for a wide range of accessories. Quickly adapt your side-by-side for any adventure, knowing your gear stays secure, no matter how rough the trail gets.

## OPTIMIZED STORAGE WITH DEFENDER G2

Trail-ready straight from the box, the Defender G2 Cargo Box includes strategically pre-marked mounting points for easy rig customization, no matter your chosen system.

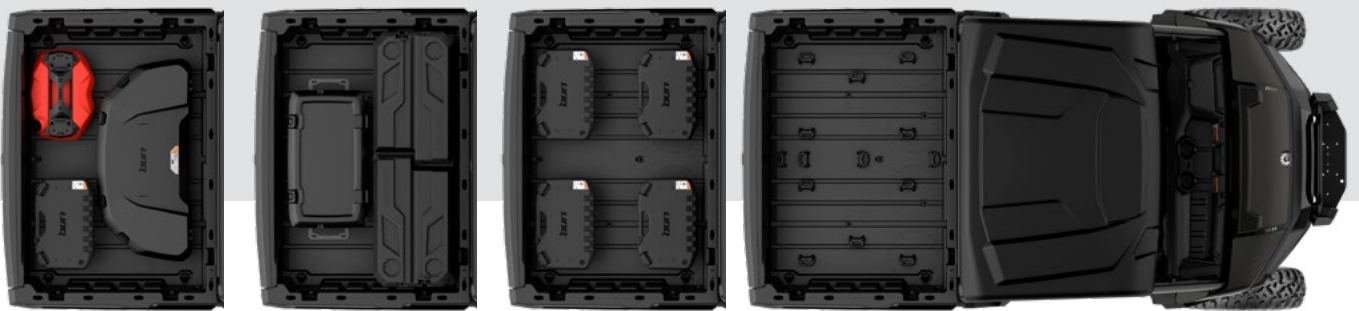

## COUNTLESS OPTIONS

**LinQ ORIGINAL SYSTEM**  
is compatible with all medium- to large-sized accessories, including 16" and 36" base units.

**LinQ LITE**  
is designed for compact, on-the-go storage (max. 4.5 lb (2 kg) per latch). It lets you mount accessories to rails or vertical surfaces.

# LINQ: EASY ON, EASY OFF CARGO

## DEFENDER LinQ ACCESSORY MOUNTING LOCATIONS AND REQUIREMENTS

<ul style="list-style-type: none"> <li>No tools needed: Quickly install and remove accessories by hand.</li> <li>Equip your Can-Am for specialized tasks in no time.</li> <li>Sturdy mounting system that holds up to the roughest terrain.</li> </ul>	DEFENDER G1				DEFENDER G2						
	Cargo Bed (long box bed LinQ) G1 6x6 & PRO	LinQ Cargo Rack 715006140	Adventure Roof Rack 715003870 / 715004391	Loadout Rack 715005447	Cargo Bed (short box bed LinQ)	Cargo Rack 715009148 / 715009170					
<b>LinQ ACCESSORIES WITH 16" BASE</b> <ul style="list-style-type: none"> <li>LinQ anchors mounted 16 inches apart, center-to-center.</li> <li>Lower loading capacity than the LinQ with 36" base accessories.</li> <li>Can be used on Can-Am ATV and SxS vehicles, Can-Am Spyder and Ryker vehicles, Sea-Doo watercraft and Ski-Doo snowmobiles.</li> </ul>											
<b>NEW LinQ Fuel Caddy 5 Gal (20 L)</b> 715007822	LinQ Base Installation Kit 715008125	No compatibility	No compatibility	LinQ Base Installation Kit 715008125	LinQ Base Installation Kit 715008125	LinQ Base Installation Kit 715008125					
<b>NEW LinQ Fuel Caddy 3.8 Gal (14.5 L)</b> 295100950		LinQ Base Installation Kit 715008125	LinQ Base Installation Kit 715008125								
<b>NEW LinQ Rigid Cooler 4.7 US Gal (18 L)</b> 715010491 - Black		No compatibility	No compatibility								
<b>NEW LinQ Cooler 5.3 Gal (20 L)</b> 295101257 - Gray		No compatibility	No compatibility								
<b>LinQ Cooler 11.4 Gal (43 L)</b> 715007825 - Black 715009276 - Gray		No compatibility	No compatibility								
<b>LinQ Tool Kit</b> 715006829		LinQ Base Installation Kit 715008125	LinQ Base Installation Kit 715008125				LinQ Base Installation Kit 715008125	LinQ Base Installation Kit 715008125	LinQ Base Installation Kit 715008125		
<b>LinQ Tool Box</b> 715008111											
<b>LinQ SR Bag 5.5 Gal (21 L)</b> 860202449											
<b>LinQ Sport Bag 4.5 Gal (17 L)</b> 860202447											
<b>LinQ Modular Box</b> 715005494 - (10 L) 715007112 - (20 L) 715006830 - (30 L)											
<b>LinQ Roll-Top Bag 10.5 Gal (40 L)</b> 715008110											
<b>LinQ Explorer Bag 26 Gal (100 L)</b> 295101016											
<b>LinQ Semi-Rigid Cooler 5.3 Gal (20 L)</b> 295101252											
<b>LinQ ACCESSORIES WITH 36" BASE</b> <ul style="list-style-type: none"> <li>Mount on LinQ racks often used by Can-Am ORV vehicles.</li> <li>Higher loading capacity than the LinQ with 16" base accessories.</li> <li>Usage is limited to Can-Am ORV vehicles.</li> </ul>	No compatibility			No further requirements	No further requirements	No further requirements				No compatibility	No compatibility
<b>LinQ Cargo Box 12 Gal (45 L)</b> 715003879											
<b>LinQ Trunk Box 23 Gal (86 L)</b> 715004923											
<b>LinQ Audio Cargo Box 11.5 Gal (43 L)</b> 715003018											
<b>LinQ Cargo Box 14 Gal (53 L)</b> 715006997											
<b>LinQ Cooler Box 8 Gal (30 L)</b> 715004778 - Black											
<b>LinQ Cooler Box 9.2 Gal (35 L)</b> 715006998 - Black											
<b>LinQ Premium Storage Bag by OGIO</b> 715002923 - Black											
<b>LinQ Heavy Duty Basket</b> 715001215											
<b>LinQ Low Profile Basket</b> 715004282											
<b>NEW LinQ Cargo Basket 23 Gal (90 L)</b> 715005274											
<b>LinQ HOLDERS</b>											
<b>LinQ Gear Grips</b> 715005340	No further requirements	No further requirements	Side wall installation LinQ Adapters 715003058	Side wall installation LinQ Adapters 715003058	No further requirements	No further requirements					
<b>LinQ Tool Holder</b> 715007358	No further requirements	No further requirements	Side wall installation LinQ Adapters 715003058	Side wall installation LinQ Adapters 715003058	No further requirements	No further requirements					

## LinQ ACCESSORIES WITH 16" BASE

**NEW LinQ 5 US Gal (20 L) Fuel Caddy** | G2, G2 MAX | **715007822** | **\$212.99**



- Quick, easy and secure LinQ system installation.
- Spill-free spout for easy use.
- 5 US gal (20 L) capacity.
- Meets new Flame Mitigation Device (FMD) standard.
- Dimensions: 12" L x 19" W x 12" H.

**NEW LinQ 3.8 US Gal (14.5 L) Fuel Caddy** | G2, G2 MAX | **295100950** | **\$276.99**



- Quickly and easy, secure installation with the LinQ accessory system.
- No-spill spout designed for easy pouring.
- 3.8 US gal (14.5 L) capacity.
- Dimensions: 13" L x 19" W x 9" H.
- Note: Fuel caddies cannot be stacked.

**NEW LinQ Rigid Cooler 4.7 US Gal (18 L)** | G1, G1 MAX, G2, G2 MAX | **715010491** | **\$394.04**



- Versatile LinQ 16" configuration fits many vehicles.
- Durable rotomolded rigid construction.
- Molded-in handles for quick installation and removal.
- High quality insulation for optimal ice retention.
- Sealed lid for airtight, weather-tight closure.
- Ergonomic and secure latch system offers excellent sealing.
- 4.7 US gal (18 L) capacity.

**NEW LinQ Cooler 5.3 US Gal (20 L)** | G1, G1 MAX, G2, G2 MAX | **295101257** | **\$409.99**



- LinQ-mounted for fast, easy and secure storage.
- Locks in place with just a quarter turn.
- High-quality insulation for optimal ice retention.
- Keeps ice cold for 5 days.
- Rotomolded construction for exceptional rigidity and durability.
- Sealed lid for airtight, weather-tight closure.
- Rigid handles make transportation easy.
- Horizontal locking handles allow for installation of LinQ Lite accessories.

- Holds thirty-four 355 ml cans.
- 5.3 US gal (20 L) capacity.
- Exterior dimensions: 21" L x 15" W x 14" H (52 cm L x 38 cm W x 35 cm H).
- Interior dimensions: 15" L x 10" W x 9" H (39 cm L x 26 cm W x 23 cm H).
- LinQ Base Installation Kit (715008125) is required for installation.

*Note: Cannot be mounted on the LinQ Stackable Fuel Caddy.*

**NEW LinQ Semi-Rigid Cooler 5.3 US Gal (20 L)** | G2, G2 MAX | **295101252** | **\$265.99**



- 5.3 US gal (20 L) of insulated, water-resistant capacity.
- Quick, easy and secure LinQ system installation.
- Attaches with one set of LinQ fasteners.
- Single day use soft cooler.
- Mesh pocket on top of the lid.

- Zippered pocket under the lid for quick and easy access.
- Removable interior for easy cleaning.
- Carry handles for easy transport.
- Can contain twelve 355 ml cans.
- Dimensions: 19" L x 13" W x 10" H.

**LinQ 11.4 US Gal (43 L) Cooler** | G1, G1 MAX, G2, G2 MAX | **715007825** - Black | **715009276** - Gray | **\$638.99**



- Versatile LinQ 16" configuration fits many vehicles.
- High quality injection-molded impact resistant polypropylene outer shell for exceptional durability.
- High quality insulation for optimal ice retention.
- Thicker insulation on bottom to isolate vehicle heat.
- 11.4 US gal (43 L) capacity.
- LinQ-mounted for fast, easy, secure storage.
- Locks in place with only a quarter turn.
- Rigid handles make transportation easy.
- Horizontal locking handles allow installation of LinQ Lite accessories.

- Dry-basket included to protect items.
- Drain plug at the bottom to evacuate water.
- New ergonomic and secure latch system offers excellent sealing.
- Possibility to lock the cooler with a padlock.
- See table for installation location and requirements.

<b>LinQ Modular Box</b>	G1, G1 MAX, G2, G2 MAX	<b>715005494</b> • (10 L)	<b>\$148.99</b>
		<b>715007112</b> • (20 L)	<b>\$170.49</b>
		<b>715006830</b> • (30 L)	<b>\$191.49</b>



- Allows stacking of other modular boxes to always have the right gear accessible.
- Always have the right box size to fit everything.
- Can be installed on any LinQ base with a 16" width.
- See table for installation location and requirements.

<b>Thermal Insert for LinQ Modular Box (10 L)</b>	Defender, Defender MAX	<b>219401110</b>	<b>\$63.99</b>
---	------------------------	------------------	----------------



- Insulated liner.
- Fits very well in the LinQ Modular Box (10 L).
- Can contain seven 355 ml cans.
- Keeps ice cold for one day.
- Interior dimensions: 9" L x 17" W x 2½" H.

<b>LinQ Tool Box</b>	G1, G1 MAX, G2, G2 MAX	<b>715008111</b>	<b>\$191.49</b>
----------------------	------------------------	------------------	-----------------



- High precision injected HDPE construction provides rigidity and durability.
- 5 gal (19 L) maximum capacity.
- Weather-resistant, sealed and lockable cover.
- Easy one-second on/off tool-less system.
- All the benefits of LinQ—simple, fast and secure.
- See table for installation location and requirements.

<b>LinQ Tool Kit</b>	G1, G1 MAX, G2, G2 MAX	<b>715006829</b>	<b>\$352.99</b>
----------------------	------------------------	------------------	-----------------



- Includes:
- Cutter pliers
  - Long-nose pliers
  - Locking pliers
  - Ratchet wrench ¾" drive
  - 6" ratchet extension
  - Integrated CVT belt storage location (belt not included)
  - Long-socket 19 mm ¾" drive – 6 pts
  - Socket 18 mm ¾" drive
  - Long-socket 17 mm ¾" drive – 6 pts
  - Socket 15 mm ¾" drive
  - Socket 13 mm ¾" drive
  - Socket 10 mm ¾" drive
  - Socket 8 mm ¾" drive
  - Socket Torx T40 ¾" drive
  - Socket Torx T30 ¾" drive
  - Socket Torx T20 ¾" drive
  - Breaker bar ¾" drive
  - Combination wrench set:
    - Wrench 19 mm
    - Wrench 18 mm
    - Wrench 15 mm
  - Wrench 13 mm
  - Wrench 10 mm
  - Wrench 8 mm
- See table for installation location and requirements.

<b>LinQ SR 5.5 Gal (21 L) Bag</b>	G1, G1 MAX, G2, G2 MAX	<b>860202449</b>	<b>\$244.99</b>
-----------------------------------	------------------------	------------------	-----------------



- Semi-rigid expandable bag.
- All the benefits of LinQ—simple, fast and secure.
- Easy one-second on/off tool-less system.
- Requires LinQ Base Installation Kit.
- 5.5 gal (21 L) capacity.
- See table for installation location and requirements.

<b>LinQ 4.5 Gal (17 L) Sport Bag</b>	G1, G1 MAX, G2, G2 MAX	<b>860202447</b>	<b>\$223.49</b>
--------------------------------------	------------------------	------------------	-----------------



- All the benefits of LinQ—simple, fast and secure.
- 4.5 US gal (17 L) capacity.
- Thermoformed bag base in HDPE (High Density Polyethylene) providing rigidity and durability.
- Rigid bottom, semi-rigid top.
- Easy one-second on/off tool-less system.
- See table for installation location and requirements.

<b>LinQ Roll-Top Bag</b>	G1, G1 MAX, G2, G2 MAX	<b>715008110</b>	<b>\$244.99</b>
--------------------------	------------------------	------------------	-----------------



- Fully waterproof roll-top dry bag will securely store and confine your equipment.
- LinQ mounted using heavy-duty rigid plastic base.
- High capacity storage solution (40 L).
- Bottom foam liner for additional equipment protection.
- Integrated handle for easy transportation on/off the vehicle.
- Dimensions: 14" L x 19" W x adjustable H.
- See table for installation location and requirements.

<b>LinQ Explorer Bag</b>	G1, G1 MAX, G2, G2 MAX	<b>295101016</b>	<b>\$478.99</b>
	<ul style="list-style-type: none"> <li>• 26 gal (100 L) of watertight storage.</li> <li>• Installs in seconds with tool-less LinQ accessory system.</li> <li>• Dedicated essentials compartment for registration, license, insurance and more.</li> <li>• Exclusive D.E.S.S. key storage.</li> <li>• External quick-access pocket for small items like keys and wallets.</li> </ul>	<ul style="list-style-type: none"> <li>• Turns into a backpack when you get off your machine.</li> <li>• Collapsible if not fully packed with straps on both sides.</li> <li>• Dimensions: 26" L x 18" W x 14" H.</li> </ul>	

## LinQ ACCESSORIES WITH 36" BASE

<b>LinQ Cargo Basket (90 L)</b>	G2, G2 MAX	<b>715005274</b>	<b>\$255.99</b>
---------------------------------	------------	------------------	-----------------



- Made of polyethylene.
- Storage capacity of 23 gal (90 L).
- Easy to install and remove with the LinQ system.
- 6 handles on the contour to easily install bungee cords.
- Ability to install Tool Holders (715008896) to the basket.

<b>LinQ 12 Gal (45 L) Cargo Box</b>	G1, G1 MAX	<b>715003879</b>	<b>\$329.99</b>
-------------------------------------	------------	------------------	-----------------



- Holds cargo safely and securely while riding.
- LinQ mounted for easy-on, easy-off installation.
- See table for installation location and requirements.

<b>LinQ 23 Gal (86 L) Trunk Box</b>	G1, G1 MAX	<b>715004923</b>	<b>\$393.99</b>
-------------------------------------	------------	------------------	-----------------



- Lockable and weather-resistant.
- Holds cargo safely and securely while riding.
- See table for installation location and requirements.

<b>LinQ 11.5 Gal (43 L) Audio Cargo Box</b>	G1, G1 MAX	<b>715003018</b>	<b>\$829.99</b>
---	------------	------------------	-----------------



- An affordable and quick solution for adding music and storage to your next ride.
- The rear installation does not use up any cab space and allows easy listening at an average speed.
- Mounts on/off easily to hold/carry cargo safely and securely.
- The Bluetooth enabled receiver and 6.5" (16.5 cm) speakers are smartly concealed and integrated in the cover.
- Automatic shut-off function protects your battery by turning the system off after 10 minutes of inactivity.
- Backlit control panel perfect for night riding.
- Water-resistant speakers.
- See table for installation location and requirements.

<b>LinQ Cargo Box (53 L)</b>	G2, G2 MAX	<b>715006997</b>	<b>\$425.99</b>
------------------------------	------------	------------------	-----------------



- Made of polyethylene.
- Storage capacity of 14 gal (53 L).
- Easy to install and remove with the LinQ system.
- New ergonomic and resistant latch system offers excellent sealing.
- Possibility to install LinQ 16" accessories on the cover and increase the cargo capacity.
- Ability to install Tool Holders (715008896) on the box.
- Lockable with a lock on the front of the box (2 keys included).

<b>LinQ 8 Gal (30 L) Cooler Box</b>	G1, G1 MAX	<b>715004778</b> • Black	<b>\$469.99</b>
-------------------------------------	------------	--------------------------	-----------------



- Installs without vehicle modification.
- Rotomolded construction provides exceptional rigidity and durability.
- Premium-quality foam insulation for optimal ice retention.
- Integrated, fully removable compartment protects food.
- Robust rubber latches keep the cover tightly closed.
- Weather-resistant.
- Convenient drain plug.
- See table for installation location and requirements.

<b>LinQ 9.2 Gal (35 L) Cooler</b>	G2, G2 MAX	<b>715006998</b>	<b>\$641.99</b>
-----------------------------------	------------	------------------	-----------------



- LinQ-mounted for efficient and secure storage, locked in place with only a quarter turn.
- Easy to install, easy to remove using the LinQ system.
- Installation in LinQ 36" configuration.
- Made of polyethylene for exceptional rigidity and durability.
- Storage capacity of 9.2 gal (35 L).
- Lock the cooler on the vehicle using the LinQ Lock (860201968).
- Premium-quality foam insulation for optimal ice retention.
- Molded-in handles for quick installation and removal.
- Option to add a 5-slot LinQ Lite Rail on the side and at the rear of the cooler.
- A dry basket is included to protect your food from water.
- Drain plug at the bottom to get rid of excess water.
- The new ergonomic and resistant latch system ensures the top is tightly sealed.
- Innovative way to hold 12 cans (355 ml).
- Cannot be installed on the front rack.

<b>LinQ Premium Storage Bag by OGIO</b>	G1, G1 MAX	■ <b>715002923</b> • Black	<b>\$532.49</b>
---	------------	----------------------------	-----------------



- Tool-less installation and removal thanks to the LinQ system.
- 17.2 gal (65 L) capacity semi-rigid cargo bag ideal for carrying anything you need on your vehicle.
- Buckle and elastic closure with a rubber seal that prevents dust from entering the bag.
- 3-section lid for partial or full access to your bag.
- Inside separators for optimal bag organization.
- See table for installation location and requirements.

<b>LinQ Heavy-Duty Basket</b>	G1, G1 MAX	<b>715001215</b>	<b>\$297.99</b>
-------------------------------	------------	------------------	-----------------



- Made of high-strength, low-alloy steel.
- See table for installation location and requirements.

<b>LinQ Low Profile Basket</b>	G1, G1 MAX	<b>715004282</b>	<b>\$223.49</b>
--------------------------------	------------	------------------	-----------------



- Low profile, open basket increases cargo space.
- Perfect for easy access to tools, rope, winch and plow accessories.
- Multiple bungee cord and tie-down anchor points.
- Made of impact-resistant injected polypropylene.
- See table for installation location and requirements.

## LinQ CARGO & RACK

<b>NEW LinQ Cargo Bed Box</b>	G2, G2 MAX	<b>715009165</b>	<b>\$532.49</b>
-------------------------------	------------	------------------	-----------------



- Large 40 gal (150 L) multifunction weather-resistant tool box designed for cargo beds.
- Rotomolded construction provides exceptional rigidity and durability.
- LinQ mounted for easy-on, easy-off installation.
- Features built-in cup holders and integrated groove for pipe or 2x4 cutting.
- Sized to give you the option of installing 2 tool boxes in the cargo bed (the tailgate extension is not compatible with two LinQ Cargo Bed Boxes).
- Double side openings with lockable covers and rubber latches.

<b>LinQ Tailgate Extension</b>	G1, G1 MAX (except 6x6 and PRO models)	<b>715002464</b>	<b>\$319.49</b>
--------------------------------	--	------------------	-----------------





- Adds rear cargo capacity when the tailgate is open.
- Steel-tubing-system-style barrier mounts on top of the bed walls using the easy, tool-less LinQ system.
- Can be mounted to serve as cargo divider at different locations along the bed wall while preventing larger items from falling off the back.
- Stores neatly out of the way and offers additional cab area protection since it can be mounted upside down on the front bed wall as a mini headache rack.
- Anti-corrosion coating with durable powder coat finish.
- Not compatible with hard rear windows on Defender MAX produced before January 2021.

<b>LinQ Tire Holder</b>	G1, G2 (except 6x6 & PRO models), G1 MAX, G2 MAX	<b>715003448</b>	<b>\$244.99</b>
-------------------------	--	------------------	-----------------





- Cargo box spare-tire holder.
- Heavy-duty steel construction.
- Inside and outside anti-corrosion coating with durable powder coat finish.
- Mounts on top of the bed walls using the easy, tool-less LinQ system.
- Compatible with Bed Wall Extender.
- Uses BRP standard wheel bolt pattern to mount tire (nuts included).
- Accommodates BRP tires up to 28" (wheel not included).
- Quickly allows installation in multiple positions thanks to the LinQ system.
- Not compatible with cargo bed winch.

<b>LinQ Cargo Rack</b>	G1, G1 MAX	<b>715006140</b>	<b>\$447.49</b>
	<ul style="list-style-type: none"> <li>• Strong, durable steel rack.</li> <li>• Easy and tool-less installation thanks to the LinQ system.</li> <li>• Allows the installation of LinQ accessories.</li> <li>• 2 racks can be installed at the same time.</li> <li>• Allows multi-level storage on cargo bed, accommodates 5 gal (19 L) bucket.</li> </ul>	<ul style="list-style-type: none"> <li>• Helps keep cargo securely in place.</li> <li>• Multiple bungee cord and tie-down anchor points.</li> <li>• Kit includes LinQ Base.</li> <li>• Provides more usable space in the cargo box.</li> </ul>	

<b>LinQ Front Rack</b>	G1, G1 MAX	<b>715006064</b>	<b>\$532.49</b>
	<ul style="list-style-type: none"> <li>• Rugged looking front rack mounts on top of vehicle hood and provides additional storage.</li> <li>• Heavy-duty 1.25" (3.2 cm) diameter steel-tube construction.</li> <li>• Inside and outside anti-corrosion coating with durable powder coat finish.</li> <li>• Flip-up configuration provides easy access to service area.</li> </ul>	<ul style="list-style-type: none"> <li>• Allows the installation of LinQ accessories (especially for use with LinQ Low Profile Basket (715004282)).</li> <li>• Kit includes LinQ Base.</li> <li>• Multiple bungee cord and tie-down anchor points.</li> <li>• Requires Rancher Bumper (715005410) or Front Bumper (715002418 or 715005754) for installation.</li> <li>• A great place to store tools while working in the field.</li> </ul>	

## LinQ HOLDERS

<b>NEW LinQ Lite Device Holder</b>	G2, G2 MAX	<b>715009201</b>	<b>\$191.99</b>
	<ul style="list-style-type: none"> <li>• Made with strong magnets that you can trust while riding through rough terrain</li> <li>• Includes everything needed for installation on your favorite electronic devices: 2 pre-assembled Can-Am plates with 3M multi-surface adhesive.</li> <li>• 360° adjustment for an improved driving experience and immersion.</li> <li>• Secure LinQ Lite attachment allows you to install/remove the holder in seconds.</li> </ul>	<ul style="list-style-type: none"> <li>• Robust plastic and aluminum construction allows for the right fit and easy installation.</li> <li>• Compatible with the Cellphone Holder (715008786).</li> <li>• Holds most tablets and smartphones measuring between 5.1" (13 cm) and 10" (25.4 cm) (with protective case).</li> </ul>	

<b>NEW LinQ Lite Action Camera Holder</b>	G2, G2 MAX	<b>295101139</b>	<b>\$51.99</b>
	<ul style="list-style-type: none"> <li>• LinQ Lite attachment system for cameras.</li> <li>• Provides great vantage points to capture photos and videos.</li> <li>• Offers 360-angle positioning for perfect filming and taking photos.</li> <li>• Designed to hold devices securely.</li> <li>• Fast, easy attachment and removal.</li> </ul>		

<b>LinQ Lite Cup</b>	G2, G2 MAX	<b>715007804</b>	<b>\$42.49</b>
	<ul style="list-style-type: none"> <li>• Keep your beverage within reach.</li> <li>• Flexible fins adjust to various beverage container sizes to hold most securely.</li> <li>• No permanent installation point means you're free to move it almost anywhere.</li> <li>• Tool-less placement, easy to move from place to place.</li> </ul>		

<b>LinQ Tool Holder</b>	G1, G1 MAX, G2, G2 MAX	<b>715007358</b>	<b>\$63.99</b>
	<ul style="list-style-type: none"> <li>• Ultra-versatile tool holder.</li> <li>• Convenient swivel-latch allows tools to be stored in any orientation.</li> <li>• Suitable for installation onto the cargo walls, Deluxe Headache Rack, Bed Wall Extender, Adventure Roof Rack and LinQ Loadout Rack.</li> <li>• If mounted on the Deluxe Headache Rack or the Bed Wall Extender, LinQ Adapter is required for installation.</li> <li>• Sold in pairs.</li> </ul>		

<b>LinQ Gear Grips</b>	G1, G1 MAX, G2, G2 MAX	<b>715005340</b>	<b>\$160.49</b>
	<ul style="list-style-type: none"> <li>• Durable and flexible grips provide a custom fit for a variety of items from 1" to 4" (2.5 cm to 10 cm) in diameter.</li> <li>• Heavy-duty design for carrying bows, fishing poles, rakes, farm tools and more.</li> <li>• Quick-release button opens grip quickly for easy access to gear.</li> <li>• Heavy-duty base system built for the toughest adventures.</li> <li>• Make transporting your tools a snap by combining the Gear Grips with the LinQ system.</li> <li>• 360° orientation.</li> <li>• Sold in pairs.</li> </ul>		

## LinQ MOUNTING

<b>LinQ Adapter</b>	G1, G1 MAX, G2, G2 MAX	<b>715003058</b>	<b>\$36.99</b>
---------------------	------------------------	------------------	----------------



- Allows the installation of the LinQ Tool Holder to the Bed Wall Extender, Adventure Roof Rack or the Deluxe Headache Rack.
- Sold in pack of 4.

<b>LinQ Lock</b>	G1, G1 MAX, G2, G2 MAX	<b>860201968</b>	<b>\$66.99</b>
------------------	------------------------	------------------	----------------



- Simple way to securely lock most LinQ accessories.
- Lock cover protects lock from the elements.
- Corrosion resistant.
- Pack of 1, includes 2 keys.
- Not compatible with LinQ 4.2 US gal (16 L) Cooler, LinQ Tool Box, LinQ Tool Holder or LinQ Gear Grips.

<b>LinQ Base Installation Kit</b>	G1, G1 MAX, G2, G2 MAX	<b>715008125</b>	<b>\$31.99</b>
-----------------------------------	------------------------	------------------	----------------



- Unique mounting fastener usable on any LinQ system accessory.
- Included: 2 LinQ Cargo Bases and hardware.

<b>LinQ Replacement Part</b>	G1, G1 MAX, G2, G2 MAX	<b>715010798</b>	<b>\$42.49</b>
------------------------------	------------------------	------------------	----------------



- Unique mounting fastener usable on any LinQ system accessory.
- Tool-less installation and removal.
- Sold in pairs.

# CARGO & STORAGE

<b>NEW Cargo Rack Multi-position</b>	G2	<b>715009148</b>	<b>\$692.24</b>
--------------------------------------	----	------------------	-----------------



- Built with heavy-duty stamped steel sheet metal with powder-coated finish.
- Loads of up to 70 lb (32 kg).
- 31" (79 cm) x 53" (135 cm) cargo basket area.
- 2 LinQ anchors on each outer side for LinQ Tool Holder (715007358).
- Many LinQ anchors can be installed at the bottom of the cargo tray to mount various LinQ accessories. 7 different positions available for LinQ 16" and 2 for LinQ 36".
- Integrated mounting points in the front for LED Light Bars (715008745 or 715008747).
- Multiple tie-down points on the sides so you can tie your gear.
- Fits on the roof with no additional requirements other than having a Sport Roof.
- Can also be installed over the cargo bed wall with the Cargo Rack Mounting Kit (715010079) or on the bed wall extenders with the Cargo Rack Mounting Kit (715010078).
- Not compatible with MAX models or Audio Roof.

<b>NEW Cargo Rack MAX</b>	G2 MAX	<b>715009170</b>	<b>\$1,011.74</b>
---------------------------	--------	------------------	-------------------



- Built with heavy-duty stamped steel sheet metal with powder-coated finish.
- Loads of up to 70 lb (32 kg).
- 61" x 53" cargo basket area.
- 4 LinQ anchors on each outer side for LinQ Tool Holder (715007358).
- Many LinQ anchors can be installed at the bottom of the cargo tray to mount various LinQ accessories. 14 different positions available for LinQ 16" and 4 for LinQ 36".
- Integrated mounting points in the front for LED Light Bars (715008745 or 715008747).
- Multiple tie down points on the sides so you can tie your gear.
- Roof mounted only.
- Installation of the Sport Roof is required.
- Not compatible with Audio Roof.

**NEW Cargo Rack Mounting Kit for Bed Wall Extender**

G2, G2 MAX

**715010078**

**\$74.54**



- Allows installation of the Cargo Rack Multi-Position (715009148) on the Low or High Bed Wall (715009590, 715010833 or 715009166).

**NEW LinQ Cargo Rack Mounting Kit for Cargo Bed**

G2, G2 MAX

**715010079**

**\$159.74**



- Allows installation of the Cargo Rack Multi-Position (715009148) on the cargo bed.
- Allows a clearance of 15" (40 cm).
- LinQ system for a fast install and removal.

**NEW Foldable Tailgate Extension**

G2, G2 MAX

**715009179**

**\$404.69**



- Foldable tailgate extension that stores on the vehicle and is always there when needed.
- Effortless installation using the tailgate striker bolts. Just unfold each side and hook them in.
- Can be quickly and completely removed from the vehicle without any tools.
- Rotomolded plastic construction for rugged durability.
- Adds rear cargo capacity when the tailgate is open.
- Not EC compliant.

**Loadout Rack**

G1, G1 MAX

**715005447**

**\$1,519.49**



- LinQ installed versatile rack that creates a second level of storage.
- Adjustable height that goes from mid cab height to roof line.
- Modular basket adapts to different cargo with folding front and rear panels.
- Multiple hooks and holes to hang items both inside and outside the rack.
- Basket accommodates multiple LinQ positions.
- Combine with cargo net to create a hanging storage net below the basket for additional space.
- 2 racks can be installed on Defender Pro and Defender 6x6.

**Hanging Storage Box Kit**

G1, G1 MAX

**715005449**

**\$176.49**



- Versatile rack designed to hold a standard storage box.
- Fully adjustable, the rack can be tailored to hold the crates in multiple positions: headache rack position, inside the box along the side wall, and outside the box along the side wall.
- Includes Can-Am branded storage box.
- Exterior Cargo Reinforcement Panel is recommended when used outside of bed wall.

**Can-Am Storage Box**

*(Not illustrated)*

G1, G1 MAX

**708303237**

**\$15.99**

- Conventional 13" x 13" plastic storage box with Can-Am branding.
- Perforated bottom allows water and debris to escape.

**Exterior Cargo Reinforcement Panel**

*(Not illustrated)*

G1, G1 MAX

**715006198**

**\$64.99**

- Plate that attaches to the bed side to further support and protect bed wall when in outward position.
- Recommended use of the hanging storage box and/or gun and tool holder when installed outside of the bed wall (except Defender 6x6 & PRO).

**NEW Headache Rack**

G2, G2 MAX (except X mr models)

**715009171**

**\$492.19**



- Protects cab components from cargo load.
- 4 LinQ anchors integrated to the frame.
- Forged steel corner where you can add tie-down to secure your material.
- Complete with wire screen design.
- Compatible with LinQ Gun Case (715009240).
- Increases box capacity when used in tandem with the Bed Wall Extender (715009590 & 715009166).
- Required to install the Bed Wall Extender - High (715009590).
- Not compatible with Snorkel Kit (715009151).

<b>Deluxe Headache Rack</b>	G1, G1 MAX	<b>715002423</b>	<b>\$491.99</b>
-----------------------------	------------	------------------	-----------------



- Protects cab components from cargo load.
- Increases box capacity when used in tandem with the Bed Wall Extender (715002421).
- Required to install the Bed Wall Extender (715002421).
- Compatible with gear rail.

<b>NEW Bed Wall Extender – Low</b>	G2, G2 MAX	<b>715009166</b>	<b>\$534.99</b>
------------------------------------	------------	------------------	-----------------



- Extend your cargo box by 16" (422 mm) with this Bed Wall Extender.
- Allows the installation of the Cargo Rack Multi-position over the bed to create a second level of storage.
- 1.25" (3.2 cm) diameter steel-tube construction.
- Inside and outside anti-corrosion coating with durable powder coat finish.
- Forged steel corner where you can add tie-downs to secure your material.
- Outer panels in robust glass-filled plastic with LinQ Nano anchors.
- 2 LinQ anchors at the ends of each panel for installing LinQ Tool Holders (715007358).
- Each upper end is equipped with a ruler to facilitate measurement.
- Quick and simple installation.
- Not compatible with Cargo Bed Winch (715009419) or Snorkel Kit (715009151).

<b>NEW Bed Wall Extender – High</b>	G2, G2 MAX	<b>715010833</b>	<b>\$695.49</b>
-------------------------------------	------------	------------------	-----------------



- Extend your cargo box by 29" (755 mm) with this Bed Wall Extender.
- Allows the installation of the Cargo Rack Multi-position over the bed to create a second level of storage.
- 1.25" (3.2 cm) diameter steel-tube construction.
- Inside and outside anti-corrosion coating with durable powder coat finish.
- Forged steel corner where you can add tie-downs to secure your material.
- Outer panels in robust glass-filled plastic with LinQ Nano anchors.
- 2 LinQ anchors at the ends of each panel for installing LinQ Tool Holders (715007358).
- Each upper end is equipped with a ruler to facilitate measurement.
- Quick and simple installation.
- Not compatible with Cargo Bed Winch (715009419) or Snorkel Kit (715009151).

<b>NEW Bed Wall Extender – High (for Headache Rack)</b>	G2, G2 MAX	<b>715009590</b>	<b>\$615.24</b>
---	------------	------------------	-----------------



- Extend your cargo box by 29" (755 mm) with this Bed Wall Extender.
- Allows the installation of the Cargo Rack Multi-position over the bed to create a second level of storage.
- 1.25" (3.2 cm) diameter steel-tube construction.
- Inside and outside anti-corrosion coating with durable powder coat finish.
- Forged steel corner where you can add tie-downs to secure your material.
- Outer panels in robust glass-filled plastic with LinQ Nano anchors.
- 2 LinQ anchors at the ends of each panel for installing LinQ Tool Holders (715007358).
- Each upper end is equipped with a ruler to facilitate measurement.
- Quick and simple installation.
- Requires Headache Rack (715009171).
- The Bed Wall Extender (715010833) can be installed without the Headache Rack.
- Not compatible with Cargo Bed Winch (715009419) or Snorkel Kit (715009151).

<b>Bed Wall Extender</b>	G1, G1 MAX (except G1 6x6 & G1 PRO)	<b>715002421</b>	<b>\$1,069.99</b>
	G1 6x6 & PRO models	<b>715005411</b>	<b>\$1,818.99</b>



- Increases box capacity.
- Quick and easy tool-less modularity.
- Easily removable rear door can be latched open.
- Variable full or half height settings.
- Foldable top panels come off in seconds.
- Requires Deluxe Headache Rack (715002423).

<b>Tonneau Cover</b>	G1 2018 & up (except Mossy Oak Break-Up Country Camo models), G1 MAX (except 6x6 and PRO models)	<b>715008306</b>	<b>\$308.99</b>
----------------------	---	------------------	-----------------



- Fitted to cover all of the items in your cargo box thoroughly.
- Prevents splash from entering the cargo box.
- Rolls up to the front.
- Easily removable for quick access.
- Not compatible with accessories that exceed the box height.

<b>Removable Storage Bin</b>	G1, G1 MAX	<b>715004344</b>	<b>\$88.99</b>
------------------------------	------------	------------------	----------------



- Handy, removable on-dash tool box will make sure you have your critical equipment where you need it.
- Provides 1.7 gal (6.3 L) of storage and clips on and off in a snap.
- Water-resistant to ensure your contents remain safe and dry.
- Standard on all models except Base and DPS.

<b>Removable Storage Bin – Passenger</b>	G1, G1 MAX, G2, G2 MAX	<b>715003314</b>	<b>\$106.49</b>
--	------------------------	------------------	-----------------



- Convenient passenger-side underseat storage.
- Polypropylene-injected 3.7 gal (14 L) storage capacity bin.
- Bin installs and removes in a snap and comes with an integrated handle.
- Water-resistant.

<b>Driver Underseat Storage Bin</b>	G1, G1 MAX	<b>715003399</b>	<b>\$138.49</b>
-------------------------------------	------------	------------------	-----------------



- Polypropylene-injected 4 gal (15 L) capacity bin fits securely under the driver's seat.
- Front opening for quick and easy access.
- Ideal for storing weather-resistant items, such as ropes, tow straps and winch accessories that are needed at a moment's notice.

<b>NEW Center Underseat Storage Bin (7 L)</b>	G2, G2 MAX	<b>715009199</b>	<b>\$85.19</b>
---	------------	------------------	----------------



- Polypropylene-injected 1.8 US Gal (7 L) capacity storage bin.
- Watertight design keeps ice and drinks cold.
- Easy to remove and wash thanks to its integrated handle.
- Designed to receive a second battery when used with the Auxiliary Battery Installation Kit (715009473).
- Integrated drain plug allows easy draining.
- Accessible by lifting center seat section.

<b>Center Underseat Storage Bin</b>	G1, G1 MAX	<b>715003446</b>	<b>\$106.49</b>
-------------------------------------	------------	------------------	-----------------



- Polypropylene-injected 2 gal (8 L) capacity storage bin.
- Watertight design keeps ice and drinks cold.
- Easy to drain and wash by removing it with integrated handle.
- Accessible by lifting center seat section.

<b>Cargo Bed Rails</b>	G1 (except 6x6 & PRO), G1 MAX	<b>715003444</b>	<b>\$148.99</b>
------------------------	-------------------------------	------------------	-----------------



- Add integrated tie-down area to your cargo box while enhancing the look.
- Added cargo box protection.
- Inside and outside anti-corrosion coating with durable powder coat finish.
- Heavy-duty 1" (2.5 cm) diameter steel-tube construction.
- Add height to the bed side wall and serve as a tie-down anchor for ropes, straps or bungees.
- Not compatible with Bed Wall Extender.
- Sold in pairs.

<b>Cargo Bed Net</b>	Defender (except 6x6 & PRO), Defender MAX	<b>715003445</b>	<b>\$88.99</b>
----------------------	---	------------------	----------------



- Solid net designed to hook to the bottom of the cargo box for secure and compact confinement of your cargo.
- Keeps items tightly against the bed floor.

<b>Dash Storage Compartment Net for Heating System</b>	G1, G1 MAX (2019 & prior)	<b>715003544</b>	<b>\$34.99</b>
--	---------------------------	------------------	----------------



- Perfect for securing items in the dash storage area.
- To be installed when Lower Dashboard for Heating System is installed.

<b>Lower Dashboard for Heating System</b>	G1, G1 MAX (2019 & prior)	<b>715003441</b>	<b>\$91.49</b>
---	---------------------------	------------------	----------------



- Replaces the dashboard that comes stock with the vehicle and features a tablet that makes it possible for driver and passenger to conveniently store small items in the dash.
- To be installed when the Defrost, Heat & Ventilation System is installed.
- Use together with the Dash Storage Compartment Net for Heating System (715003544) to prevent the items placed in the dash storage compartment from falling.

<b>Dash Storage Compartment Nets</b>	G1, G1 MAX (except Limited models)	<b>715003129</b>	<b>\$36.99</b>
--------------------------------------	------------------------------------	------------------	----------------



- Perfect for securing items in the dash storage area.
- Not compatible with Defrost, Heat & Ventilation System.
- Sold in pairs.

<b>Backrest Rear Storage</b>	G1 MAX, G2 MAX	<b>715003019</b>	<b>\$63.99</b>
------------------------------	----------------	------------------	----------------



- Netting installs easily.
- Made from polyester that won't discolor.
- Sold in pairs.

<b>Storage 2.6 Gal (10 L) Bag</b>	G1, G1 MAX, G2, G2 MAX	<b>269502121</b>	<b>\$40.49</b>
-----------------------------------	------------------------	------------------	----------------



- Roll-top dry bag for fully protecting your cargo from the elements.

<b>Passenger Storage Seat Bag</b>	G1, G1 MAX, G2, G2 MAX	<b>715008080</b>	<b>\$265.99</b>
-----------------------------------	------------------------	------------------	-----------------



- This weather-resistant bag holds your gear safely and securely while you ride.
- Bag settling on the passenger's seat to increase the vehicle's cargo capacity.
- This bag features a 14.5 gal (55 L) storage capacity and is divided into two compartments.
- The top compartment is insulated to keep your beverages cold and includes two cup holders.
- Additional pocket inside for additional storage, such as a cell phone.
- The bottom compartment is accessible from both sides and serves as a large pocket for storing various items.
- The detachable pocket at the front of the bag can be used as a garbage bag.

## RACKS & HOLDERS

<b>Rear Accessory Bar</b>	G1, G1 MAX	<b>715005450</b>	<b>\$132.99</b>
---------------------------	------------	------------------	-----------------



- Strong accessory bar allowing installation or hanging items off the back.
- Holes for carabiners, duck decoy hangers or other items.
- LinQ anchors allow installation of many LinQ accessories.

<b>Adventure Roof Rack</b>	G1 Loads of up to 71 lb (32 kg).	<b>715003870</b>	<b>\$702.49</b>
	G1 MAX Loads of up to 71 lb (32 kg).	<b>715004391</b>	<b>\$851.49</b>



- Ideal cargo solution for packing everything you need to live your off-road experience fully and completely.
- Built with heavy-duty 1.25" (3.2 cm) diameter steel tubing.
- Modular LinQ support plates allow for installation of most LinQ cargo accessories.
- Integrated mounting points for lights can hold up to 8 pod-type LED lights (6 front and 2 back) or a 39" (99 cm) LED bar (front)—see table for compatibility.
- Features anchor points for spare tire attachment.
- Spare Tire Tie-Downs sold separately.
- Add the Cargo Box Net or the Cargo Box Elastic Net to secure and confine your cargo in the rack.
- Not compatible with Bimini Roof or Audio Roof.

<b>Spare Tire Ratchet Tie-Downs</b>	G1, G1 MAX	<b>280000955</b>	<b>\$35.49</b>
-------------------------------------	------------	------------------	----------------



- 3-way ratcheting tie-down strap with loop ends.
- Designed to securely hold spare tires on accessories equipped with integrated spare tire attachment points.
- Adjustable to accommodate most common UTV tire sizes.
- Ratchet and junction ring made of durable zinc-plated steel.
- Required for spare tire attachment on Adventure Roof Rack.

<b>LinQ Tool &amp; Gun Holder</b>	G1, G1 MAX G2, G2 MAX	<b>715005466</b>	<b>\$566.99</b>
-----------------------------------	-----------------------	------------------	-----------------



- 2-in-1 holding rack can be used both on the job or on the hunt.
- Includes 5 locations to securely hold tools and guns using rubber grips and retention straps at the top and a rubber mat with gunstock shaped molding at the bottom.
- Easy to remove, install or reposition using our simple and secure LinQ system.
- Can be attached at multiple positions along the cargo bed walls, facing inside or outside the bed.
- Recommended to use with the Exterior Cargo Reinforcement Panel (715006198) when installed outside the bed wall.

<b>LinQ Gun Case</b>	G1, G1 MAX, G2, G2 MAX	<b>715009240</b>	<b>\$277.99</b>
----------------------	------------------------	------------------	-----------------



- Practical design allows you to store shotguns and rifles up to 52" (132 cm) even with most optic configurations.
- Adapts to different weapon shapes and features with foam cushions that can be repositioned.
- LinQ-mounted for efficient and secure storage, locked in place with only a quarter turn.
- LinQ Gun Case Mounting Kit (715006443) is required for installation.

<b>LinQ Gun Case Mounting Kit</b>	G1, G1 MAX, G2, G2 MAX	<b>715006443</b>	<b>\$74.99</b>
-----------------------------------	------------------------	------------------	----------------



- Required to install the LinQ Gun Case on a Defender and Defender MAX.
- Allows you to install up to two LinQ gun cases.
- Includes one pair.

<b>Gun Boot 6.0<sup>+</sup> Impact by Kolpin<sup>†</sup></b>	G1, G1 MAX	<b>715001419</b>	<b>\$114.99</b>
--	------------	------------------	-----------------



- Extra room for pistol-grip-type weapons and small bipods.
- Easily fits firearms up to 51" (1.3 m) in total length.
- Provides ample room for 2.4" (60 mm) scopes.
- Hatchback design allows easy access.
- Snap-close cover with locking capability.
- Ergonomically designed handle and molded attachment points for sling.
- Designed to accommodate left- and right-hand bolt-action rifles and shotguns.
- Requires Gear Rail and Gun Boot Mount by Kolpin for installation.
- Includes removable, shock-absorbing foam and nylon Impact liner for superior interior protection.
- Compatible for dual mount with additional Gun Boot Mount.

<b>Gun Boot Mount by Kolpin</b>	G1, G1 MAX	<b>715001420</b>	<b>\$106.99</b>
---------------------------------	------------	------------------	-----------------



- Fits one Kolpin Gun Boot 6.0 Impact.
- Lightweight and extremely durable.
- Easily adjustable without the use of any tools.
- Offers precision gun angle adjustability.
- Requires Gear Rail for installation.

<b>Dual Gun Holder</b>	G1, G1 MAX	<b>715005265</b>	<b>\$244.99</b>
------------------------	------------	------------------	-----------------



- Accommodates shotguns, rifles or muzzleloaders.
- Mounts in the cab, on floor board between driver and passenger.
- Rubber pads provide gun protection.
- Can be removed to allow a center passenger.
- Anti-corrosion coating with durable powder coat finish.
- Comes with all hardware for easy installation.
- Keeps your weapons within easy reach and protected within the cab area.
- Refer to your local regulations governing the transportation of firearms before purchase.

<b>Gear Rail</b>	G1, G1 MAX (except X mr models)	<b>715003391</b>	<b>\$352.99</b>
------------------	---------------------------------	------------------	-----------------



- Stationary rail system specially designed for your side-by-side vehicle.
- Universal mounting options for many Kolpin accessories like Gear Grips and Universal Saw Press.
- Rail is made with heavy-duty 7-gauge extruded anodized black aluminum.
- Mounts on roll bar.
- Includes one versatile Gear Rail Mount by Kolpin.
- Requires Deluxe Headache Rack (715002423) or Gear Rail Adapter (715003392).

<b>Gear Rail Adapter</b>	G1, G1 MAX (except X mr models)	<b>715003392</b>	<b>\$203.49</b>
--------------------------	---------------------------------	------------------	-----------------



- Allows the installation of gear rails directly onto the cargo box without the need for a headache rack.

<b>Gear Rail Mount by Kolpin</b>	G1, G1 MAX	<b>715001422</b>	<b>\$54.49</b>
----------------------------------	------------	------------------	----------------



- Accessory bracket for mounting additional accessories to the Gear Rail.
- Includes C-clamp and metal mounting brackets.

<b>Double Gun Bag</b>	G1 (except XT Cab, X mr models), G1 MAX (except XT Cab and Limited package)	■ <b>715003133</b> • Black	<b>\$191.49</b>
-----------------------	--	----------------------------	-----------------



- Shell constructed with heavy-duty, weather-resistant polyester to shelter guns from dust and other outdoor elements, while the thick interior padding protects the guns from shocks.
- Fits perfectly on rear cage and guns are readily accessible from both sides of vehicle.
- Design features include a removable center pocket that can be mounted on both sides of the bag and extra front storage pockets for hunting gear.
- Solid, quick installation.
- Not compatible with rear wind protection, headache racks and gear rails.
- May interfere with the tilt function of the Defender 6x6 or Defender PRO models' beds.

<b>Universal Saw Press by Kolpin</b>	G1, G1 MAX (except X mr models)	<b>715001423</b>	<b>\$154.99</b>
--------------------------------------	---------------------------------	------------------	-----------------



- Specially crafted for transporting your chainsaw securely and safely aboard your side-by-side vehicle.
- Heavy-duty, black powder-coated metal bracket designed to attach any chainsaw model with up to a 20" (51 cm) bar.
- Rubber pads provide cushion and tight fit.
- Hinged design for quick removal.
- Holds saw in vertical position or 45° angle in either direction.
- Requires Gear Rail.
- Protective sheath included.

<b>LinQ Gear Grips</b>	G1, G1 MAX, G2, G2 MAX	<b>715001421</b>	<b>\$99.49</b>
------------------------	------------------------	------------------	----------------



- Durable, flexible grips cushion and protect while providing a custom fit for a variety of items from 1" to 4" (2.5 cm to 10 cm) in diameter.
- Heavy-duty design for carrying bows, fishing poles, rakes, farm tools and more.
- Quick-release button opens grip quickly for easy access to gear.
- Heavy-duty base system built for the toughest adventures.
- Easy installation on tubular racks, extension racks, brackets or bumpers.
- Sold in pairs.



# SMART ACCESSORIES

Powered by the ACM, SMART Accessories respond automatically to speed, steering, and other sensor data, adjusting light output, behavior, and function in real time.

## A RESPONSE SYSTEM THAT TAKES TECH TO THE NEXT LEVEL.

### ACM

This is the brain of the SMART Ecosystem. It reads multiple sensors on the vehicle and translates the reading into actions for the accessories.



### 10.25" TOUCHSCREEN DISPLAY

When your vehicle is equipped with the 10.25" touchscreen display, it allows you to control up to 19 accessories at the same time.



### SMART CONTROL CENTER

Allows you to quickly access SMART Accessories (can be used with or without the 10.25" touchscreen display).



### SMART ACCESSORIES

Accessories designed to execute multiple functions depending on the input from the ACM.



# ACM & SMART ACCESSORIES

<b>NEW Accessory Control Module</b>	G2, G2 MAX	<b>715009121</b>	<b>\$593.99</b>
-------------------------------------	------------	------------------	-----------------



- Bringing the SMART innovation to accessories using live vehicle ECU information to maximize your accessory experience.
- Connect your accessories to the 10.25" Color Touchscreen Display (if equipped).
- Easy accessory installation (plug and play).
- Creates an ecosystem that makes installing accessories quicker and easier.
- Includes ACM Front Harness and Roof Harness to connect front-mounted SMART accessories to the Accessory Control Module (five auxiliary connectors available).
- Accessory Control Center (715010834) required for models without the 10.25" Color Touchscreen Display.

<b>NEW SMART Control Center for ACM</b>	G2, G2 MAX	<b>715010834</b>	<b>\$534.99</b>
---	------------	------------------	-----------------



- Control the accessories with the selection of different modes, the illuminated halo around the button indicates the active mode.
- Icons illuminate when accessories are activated.
- Make accessory control changes without having to take your eyes off the trail by choosing the accessory button required (quick access).
- All Front LED Off button to turn off all front lights with one click. Remembers the last programmed setups when this button is pressed again.
- 6 pre-programmed buttons and 10 programmable buttons to customize according to the accessories installed.

<b>NEW SMART 10" (25 cm) LED Light Bar</b>	G1, G1 MAX, G2, G2 MAX	<b>715008745</b>	<b>\$374.49</b>
--	------------------------	------------------	-----------------



- The perfect combination of powerful white and selective yellow LEDs.
- The selective yellow LEDs are ideal for driving in low visibility conditions.
- The light is composed of 16 white LEDs and 8 yellow LEDs.
- Spot and Flood combo beam.
- The side lens design provides highly effective wide-angle illumination.
- The white LEDs produce 8,100 raw lumens and the selective yellow 2,640 raw lumens, delivering stunning lighting performance.
- The lens is made from hard-coated polycarbonate.
- IP67 and IP69k submersible and pressure washer safe.
- Switch options: Off, Low and High. Color change by flicking the switch quickly.
- SMART options: Off, Low, High, color change and SMART Automatic Mode.
- SMART MODE: Intensity increases or decreases and Spot/Flood ratio varies according to the speed of the vehicle with the installation of the Accessory Control Module (ACM).
- Accessory Control Module (715009121) is required for SMART functionality.
- Lights Wiring Harness (715009886) is required for on/off function when ACM is not installed. Sold separately.
- Just a heads-up, you'll need a bumper for this.

<b>NEW SMART 40" (102 cm) LED Light Bar</b>	G2, G2 MAX	<b>715008747</b>	<b>\$1,069.99</b>
---	------------	------------------	-------------------



- The perfect combination of powerful white or selective yellow LEDs.
- The selective yellow LEDs are ideal for driving in low visibility conditions.
- The light is composed of 64 white LEDs and 32 yellow LEDs.
- Spot and Flood combo beam.
- The side lens design provides highly effective wide-angle illumination.
- The white LEDs produce 32,000 raw lumens and the selective yellow 10,560 raw lumens, delivering stunning lighting performance.
- The lens is made from hard-coated polycarbonate.
- IP67 and IP69k submersible and pressure washer safe.
- Switch options: Off, Low and High. Color change by flicking the switch quickly.
- SMART options: Off, Low, High, color change and SMART Automatic Mode.
- SMART MODE: Intensity increases or decreases and Spot/Flood ratio varies according to the speed of the vehicle with the installation of the Accessory Control Module (ACM).
- Accessory Control Module (715009121) is required for SMART functionality.
- Wiring Harness (715009930) is required for on/off function when ACM is not installed. Sold separately.
- Requires LED Light Bar Mounts (715009261) or mounts directly to some Can-Am audio roofs.
- See table for installation location and requirements.

<b>NEW SMART LED Hood Light</b>	G2, G2 MAX	<b>715009299</b>	<b>\$342.49</b>
---------------------------------	------------	------------------	-----------------



- Mounted seamlessly on the hood, it doesn't require a bumper or brackets.
- Both ends feature angled LEDs for a wider light spread.
- Integrated signature light enhances your vehicle look and makes it instantly recognizable.
- Good option for X mr models where the bumper mounting plate is used for the winch or any other models with a relocated winch.
- Mounted higher up so less likely to be blocked by another accessory.
- 10,500 raw lumens for exceptional brightness.
- The lens is made from hard-coated polycarbonate.
- IP67 and IP69k submersible and pressure washer safe.
- Switch options: Off, Low and High.
- SMART options: Off, Low, High and SMART Automatic Mode.
- SMART MODE: It's got a unique startup light sequence that adds a touch of style every time you power up your vehicle. Intensity increases or decreases and Spot/Flood ratio varies according to the speed of the vehicle with the installation of the Accessory Control Module (ACM).
- Accessory Control Module (715009121) is required for SMART functionality.
- Lights Wiring Harness (715009886) is required when ACM is not installed. Sold separately.

**NEW SMART Intermittent Wiper & Washer Kit**

G2, G2 MAX

715009441

\$719.99



- An ideal way to keep your windshield clear in rain, or while riding through mud and water.
- Includes single-speed wiper, washer fluid dispenser and windshield frame mount.
- Automatic speed variation mode and intermittent wiper speed features available when the kit is installed in combination with ACM and that varies with vehicle speed.
- Must be used with the Glass Windshield (715010876) or Flip Glass Windshield (715009225).
- Requires Wiper and Power Cables when ACM is not installed:
  - If equipped with the Sport Roof, Power Cables (715010489 & 715009756) are required.
  - If equipped with the Audio Roof, Power Cables (715010324) is required.
- Included with Flip Glass Windshield with SMART Intermittent Wiper & Washer Kit (715009890).



# LIGHTS

## CAN-AM LIGHTS — DEFENDER G1

1 CHOOSE YOUR MOUNT POINT	2 FIND YOUR PLATFORM	3 CHOOSE YOUR LIGHTS					
		10" (25 cm) Double Stacked LED Bar 715002933	15" (38 cm) Double Stacked LED Bar 715002934	SMART 10" (25 cm) LED Light Bar 715008745	39" (99 cm) Double Stacked LED Bar 715004007	4" (10 cm) Round LED LIGHTS (sold in pairs) 715002935	3.5" (9 cm) LED Flood Lights (sold in pairs) 715009774 & 715009775
<b>Front Bumper Rancher Bumper XT Front Bumper X mr Front Bumper (w/o winch) X-TP Front Bumper</b>	Defender Defender MAX 2019 & prior	715002454 (Light Power Cable)	715002454 (Light Power Cable)	715009886 (Lights Wiring Harness)	No compatibility	715002454 (Light Power Cable) (1 harness can support 2 lights)	
	Defender Defender MAX 2020 & up	715006034 (Light Power Cable)	715006034 (Light Power Cable)	715009886 (Lights Wiring Harness)		715006034 (Light Power Cable) (1 harness can support lights)	
<b>Light Rack or Light Bars</b>  *Roof Power Cable and Front Roof Liner may not be required if already installed with other accessories	Defender & Defender MAX (except XT CAB)	715002456 (Light Rack) + 715003094 (Roof Power Cable) + 715008226 (Front Roof Liner)	715002456 (Light Rack) + 715003094 (Roof Power Cable) + 715008226 (Front Roof Liner)	715002456 (Light Rack) + 715003094 (Roof Power Cable) + 715008226 (Front Roof Liner) + 715009886 (Lights Wiring Harness)	715006226 (Light Bar Support) + 715005822 (Power Cable) + 715008226 (Front Roof Liner)	715009301 (Spotlight Support Bar) (only for 3.5" lights) + 715003094 (Roof Power Cable) + 715008226 (Front Roof Liner)	
	Defender Defender MAX XT CAB Limited	No requirements	No requirements	No compatibility	715006226 (Light Bar Support) + 715005822 (Power Cable)	No requirements	
<b>Adventure Roof Rack</b>  *Roof Power Cable may not be required if already installed with other accessories.	Defender & Defender MAX (except XT CAB Limited)	N/A	Front only: 715003417 (Power Cable) + 715003094 (Roof Power Cable) + 715008226 (Front Roof Liner)	N/A	Front only: 715005822 (Power Cable) + 715003094 (Roof Power Cable) + 715008226 (Front Roof Liner)	Front or Rear: 715002935 (4" Round), 715009774 (3.5" Flood) or 715009775 (3.5" Spot) + 715003417 (Power Cable) & 715003094 (Roof Power Cable) & 715008226 (Front Roof Liner)	
	Defender, Defender MAX XT CAB Limited		Front only: 715003417 (Power Cable)		Front only: 715005822 (Power Cable)	Front or Rear: 715003417 (Power Cable)	

**4 ORDER** **ORDER ALL PART NUMBERS IN INTERSECTING BOX**  
 \*Note: When installing more than one light kit, additional light power cable or mounting kit is required.

# CAN-AM LIGHTS – DEFENDER G2

## CAN-AM LIGHTS WITH ACM

	1 CHOOSE YOUR MOUNT POINT	2 CHOOSE YOUR LIGHTS				
		SMART 40" (102 cm) LED Light Bar 715008747	SMART 10" (25 cm) LED Light Bar 715008745	SMART LED Hood Light 715009299	3.5" (9 cm) LED Flood Lights (2 X 14 W) 715010093	3.5" (9 cm) LED Driving Lights (2 X 14 W) 715010094
SMART FUNCTIONALITY	Vehicle Integrated	No compatibility	No compatibility	Accessory Control Module 715009121	No compatibility	No compatibility
	Audio Roof 715009224/ 715009223	Accessory Control Module 715009121		No compatibility		
	LED Light Bar Mounts 715009261	No compatibility	No compatibility			
	Spotlight Support Bar 715009301	No compatibility		Accessory Control Module 715009121 + Round Lights ACM Wiring Harness 715009855 (1 harness can support 4 lights)		
	Cargo Rack Multi-position 715009148/ 715009170	Accessory Control Module 715009121	Accessory Control Module 715009121			
	Large Heavy-Duty Front Bumper 715009164	No compatibility				

## CAN-AM LIGHTS WITHOUT ACM

	1 CHOOSE YOUR MOUNT POINT	2 CHOOSE YOUR LIGHTS				
		SMART 40" (102 cm) LED Light Bar 715008747	SMART 10" (25 cm) LED Light Bar 715008745	SMART LED Hood Light 715009299	3.5" (9 cm) LED Flood Lights (2 X 14 W) 715010093	3.5" (9 cm) LED Driving Lights (2 X 14 W) 715010094
ON/OFF FUNCTIONALITY	Vehicle Integrated	No compatibility	No compatibility	Lights Wiring Harness 715009886	No compatibility	No compatibility
	Audio Roof 715009224/ 715009223	SMART 40" (102 cm) LED Light Bar Harness 715009930**	No compatibility	No compatibility		
	LED Light Bar Mounts 715009261				Lights Wiring Harness 715009886	
	Spotlight Support Bar 715009301	No compatibility	Light Kit Power Cable 715006034 (1 harness can support 2 lights)			
	Cargo Rack Multi-position 715009148/ 715009170	SMART 40" (102 cm) LED Light Bar Harness 715009930		Lights Wiring Harness 715009886		
	Large Heavy-Duty Front Bumper 715009164	No compatibility				

### 3 ORDER

### ORDER ALL PART NUMBERS IN INTERSECTING BOX

\*Note: When installing more than one light kit, additional light power cable or mounting kit is required.

\*\*Requires Front Roof Liner (715009196) for installation.

### NEW Cable Cover and Roof Power Cable Kit

G2, G2 MAX (models without Cab)

715010489

\$239.61



- Designed to organize cables and provide a safe environment by covering exposed cables.
- Required for installation of some electrical accessories.
- Brings power from the battery.
- Cable cover is made from injected plastic.
- Roof power cable included.
- Combined with the Front Roof Liner (715009196) for optimum integration.

<b>Roof Power Cable</b> <i>(Not illustrated)</i>	G1, G1 MAX	<b>715003094</b>	<b>\$63.99</b>
---	------------	------------------	----------------

- Required for installation of some electrical accessories.
- Brings power from the battery.

<b>Light Kit Power Cable</b> <i>(Not illustrated)</i>	G1, G1 MAX (2019 & prior)	<b>715002454</b>	<b>\$63.99</b>
	G1, G1 MAX (2020 & up), G2, G2 MAX	<b>715006034</b>	<b>\$52.99</b>

- Power cable for installation of compatible Can-Am light kits at front bumper location.

<b>NEW Rear LED Light</b>	G1, G1 MAX, G2, G2 MAX	<b>715008236</b>	<b>\$240.74</b>
---------------------------	------------------------	------------------	-----------------



- This high performance LED light provides full illumination for your cargo box and the surrounding area.
- Convenient front liner switch with 2 modes, High & Low.
- High beam mode illuminates up to 50 ft. (15 m) at the rear of the vehicle. Perfect for those moments when you're reversing.
- Low beam mode illuminates your cargo area to ensure easy loading without the harsh glare.
- Sport Roof, Deluxe Sport Roof, Sport Roof for MAX or Audio Roof is required for installation.
- EC compliant.
- Requires Lights Wiring Harness (715009886) and Roof Power Cable and Cable Cover Kit (715010489) & Front Roof Liner (715009196) for vehicles not already equipped.

<b>10" (25 cm) Double Stacked LED Light Bar (60 W)</b>	G1, G1 MAX, G2, G2 MAX	<b>715002933</b>	<b>\$395.49</b>
--	------------------------	------------------	-----------------

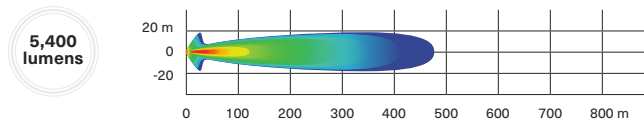

- Equipped with twelve 5 W Cree LEDs.
- 5,400 lumens.
- Packs a big punch for its size.
- Rugged and waterproof.
- Can be installed on front bumpers, Sport Roof and Bimini Roof with sun visor.
- Requires light power cable for installation.
- Lights up to more than 1,500 ft (460 m) in front of the vehicle and around 65 ft (20 m) wide on each side.
- EC compliant.
- See table for installation location and requirements.

<b>15" (38 cm) Double Stacked LED Light Bar (90 W)</b>	G1, G1 MAX, G2, G2 MAX	<b>715002934</b>	<b>\$480.99</b>
--	------------------------	------------------	-----------------

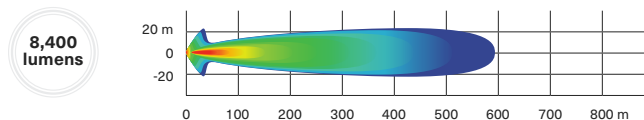

- Equipped with 18 5 W Cree LEDs.
- 8,400 lumens.
- Complements the Light Racks and most bumpers.
- Rugged and waterproof.
- Lights up to more than 1,900 ft (580 m) in front of the vehicle and around 65 ft (20 m) wide on each side.
- EC compliant.
- See table for installation location and requirements.

<b>39" (99 cm) Double Stacked LED Light Bar (270 W)</b>	G1, G1 MAX	<b>715004007</b>	<b>\$940.99</b>
---	------------	------------------	-----------------

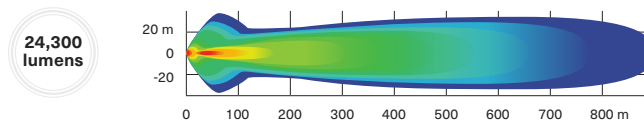

- Equipped with 54 5 W Cree LEDs.
- 24,300 lumens.
- Lights up to more than 2,900 ft (900 m) in front of the vehicle and around 115 ft (35 m) wide on each side.
- Compatible with the Adventure Roof Rack.
- Compatible with Flip Windshields and Full Windshields.
- See table for installation location and requirements.

<b>4" (10 cm) Round LED Lights (2 x 25 W)</b>	G1, G1 MAX	<b>715002935</b>	<b>\$480.99</b>
---	------------	------------------	-----------------

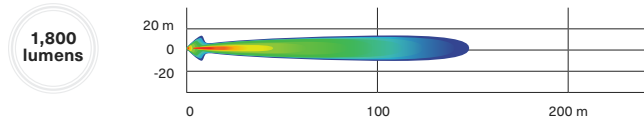

- 25 W LED spotlights.
- 1,800 lumens.
- Rugged and waterproof.
- Includes basic wiring and switch.
- Can-Am branded grill.
- Requires light power cable.
- Sold in pairs.
- Not EC compliant.
- See table for installation location and requirements.

<b>3.5" (9 cm) LED Driving Lights (2 x 14 W)</b>	G1, G1 MAX	<b>715009775</b>	<b>\$283.49</b>
	G2, G2 MAX	<b>715010094</b>	<b>\$272.84</b>

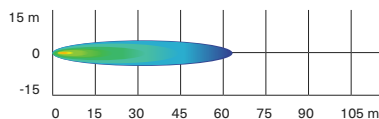

- 14 W LED lights producing 1,260 lumens each.
- Spot lens for a narrow and long light beam spread, ideal when driving at higher speeds.
- Equipped with six high-power LEDs in a heavy-duty die-cast aluminum housing.
- Features two attachment points. If one attachment point fails due to a collision, rotate to the next channel point and remount the light.
- Sold in pairs.
- EC compliant.
- See table for installation location and requirements.

<b>3.5" (9 cm) LED Flood Lights (2 x 14 W)</b>	G1, G1 MAX	<b>715009774</b>	<b>\$283.49</b>
	G2, G2 MAX	<b>715010093</b>	<b>\$272.84</b>

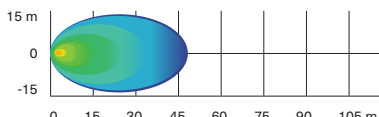

- 14 W LED lights producing 1,260 lumens each.
- Flood lens for a wide light beam spread, ideal for working applications like plowing or cornering. Suitable for dusty or foggy riding conditions.
- Equipped with six high-power LEDs in a heavy-duty die-cast aluminum housing.
- Features two attachment points. If one attachment point fails due to a collision, rotate to the next channel point and remount the light.
- Sold in pairs.
- EC compliant.
- See table for installation location and requirements.

<b>NEW LED Light Bar Mounts</b>	G2, G2 MAX	<b>715009261</b>	<b>\$85.59</b>
---------------------------------	------------	------------------	----------------



- Black cast-aluminum construction.
- Optimized Led Light Bar positioning to work with Can-Am flip windshields.
- Can be installed with or without roof.
- Required for SMART LED Light Bar 40" (715008747) or SMART LED Light Bar 10" (715008745).

<b>NEW Spotlight Support Bar</b>	G1, G1 MAX, G2, G2 MAX	<b>715009301</b>	<b>\$171.19</b>
----------------------------------	------------------------	------------------	-----------------



- Black cast-aluminum construction and aluminum extrusion providing a mounting point for lights.
- Can be installed with or without roof.
- Required to install the 3.5" Round Lights on the roof.

<b>Light Bar Support</b>	G1, G1 MAX	<b>715006226</b>	<b>\$148.99</b>
--------------------------	------------	------------------	-----------------



- Mounting bracket that allows the installation of the Can-Am 39" Lightbar (715004007).
- Low and forward mounting position for a sleek look.
- Compatible with all windshields, roofs and doors.
- This accessory is not compatible with the Can-Am Audio Roof (715005206) or Can-Am Max Audio Roof (715006879).

<b>Light Rack</b>	G1, G1 MAX	<b>715002456</b>	<b>\$208.49</b>
-------------------	------------	------------------	-----------------



- Rugged steel construction serves as both mount and protection for accessory light systems.
- Lights not included.
- Front Roof Liner is required for installation on the roof (except Cab models or with Deluxe Sport Roof).
- Power Cable, Sport Roof, Deluxe Sport Roof or Sport Roof for MAX required for installation.
- Integrates elegantly and seamlessly into our roof products.

<b>Rear Cargo Light</b>	G1, G1 MAX	<b>715007077</b>	<b>\$203.49</b>
-------------------------	------------	------------------	-----------------



- Powerful 55 W H3 illumination for rear cargo area.
- Convenient in-dash switch.
- Wiring included.
- Sport Roof (715002430) or Sport Roof for MAX (715003038) is required for installation.
- Not EC compliant.
- Not compatible with headache rack on Defender Pro and Defender 6x6.

<b>RAM<sup>+</sup> LED Spotlight</b>	G1, G1 MAX	<b>710005423</b>	<b>\$174.99</b>
--------------------------------------	------------	------------------	-----------------



- 540 lumen (9 watt) heavy-duty LED spotlight standard-equipped with 1" (2.5 cm) diameter rubber-coated double ball and socket system.

<b>NEW Dome Light</b>	G1, G1 MAX, G2, G2 MAX	<b>715009228</b>	<b>\$96.49</b>
-----------------------	------------------------	------------------	----------------



- Offers an optimal visibility in the cab and integrates perfectly with the vehicle.
- 160 lumens of soft white light ensure clear visibility of the surroundings.
- Built in on/off button on the light.
- Wiring included.
- Can be installed on cage or Sport Roof.
- Not compatible with the Defender Audio Roofs.

<b>LED Signature Lights</b>	G1, G1 MAX	<b>715006896</b>	<b>\$271.49</b>
-----------------------------	------------	------------------	-----------------



- The stylish LED set puts the finishing touch to your Defender, accentuating its aggressive stance.
- Included on Limited and Lone Star models.

<b>NEW Round Lights ACM Wiring Harness</b>	G2, G2 MAX	<b>715009855</b>	<b>\$96.29</b>
--	------------	------------------	----------------



- Required to connect the 3.5" (9 cm) LED Flood and LED Driving Lights (715010093 & 715010094) to the ACM Harness.

<b>NEW Lights Wiring Harness</b>	G1, G1 MAX, G2, G2 MAX	<b>715009886</b>	<b>\$85.59</b>
----------------------------------	------------------------	------------------	----------------



- Power cable for installation of compatible SMART LED Hood Light (715009299), SMART 10" (25 cm) LED Light Bar (715008745) or Rear LED Light (715008236).

<b>NEW SMART 40" (102 cm) LED Light Bar Harness</b>	G2, G2 MAX	<b>715009930</b>	<b>\$96.29</b>
---	------------	------------------	----------------



- Required to install the SMART 40" (102 cm) LED Light Bar (715008747) if the ACM is not installed.



Treat yourself to exceptional sound on the move. Expertly tuned and DSP-calibrated, Can-Am's JL Audio-powered systems deliver precise equalization, time alignment, crossover filtering, bass boost, and more—fine-tuning every note for high-impact sound, no matter how remote the ride.

## LEVEL UP YOUR SOUND

Choose the audio setup that matches your style.



### LEVEL 1

Wet Sounds Stealth XT 6 Can-Am Edition Sound Bar Level



### LEVEL 2

This option\* includes two 6.5" (165 mm) speakers and Frontliner PLUS, the Can-Am JL Audio Amplifier



### LEVEL 3

This option includes four 6.5" (165 mm) speakers (two dash and two surround speakers) PLUS the Can-Am JL Audio Amplifier



### LEVEL 4

This option includes a full roof with four or six 8" speakers, one 400 RMS, and an 800 peak watt amplifier supplied by Rockford Fosgate audio.

## CRANK IT UP WITH UPGRADES

Defender rigs equipped with levels 2–4 can be upgraded with an amplifier, rear speakers, or a subwoofer, so you can build the ultimate setup for every ride.

\*Two different options depending on whether there is a 10.25" touchscreen display or not.

# AUDIO & COMMUNICATION SYSTEMS

<b>NEW Can-Am JL Audio System – Level 2</b>	G2, G2 MAX	<b>715009192</b>	<b>\$1,504.99</b>
---	------------	------------------	-------------------



- Made using premium JL Audio components, including two 6.5" (165 mm) speakers and Front Liner.
- Control your music with Bluetooth connectivity.
- Can-Am JL Audio Amplifier included (715009229) with 280 watts.
- Compatible with the pre-wired Can-Am JL Audio Subwoofer & Amplifier Kit (715008094) for quick, easy installation.

- Rear Speaker Kvit (715009193) and Audio Roof can be added to deliver superior performance.
- Requires the Can-Am JL Audio Source Unit (715010002) for vehicles without 10.25" Color Touchscreen Display, installed in the center dashboard for a car-like experience.
- Requires the Cable Cover and Roof Power Cable Kit (715010489) for installation.

<b>NEW Can-Am JL Audio System – Level 2 (with Source Unit)</b> <i>(Not illustrated)</i>	G2, G2 MAX	<b>715009194</b>	<b>\$1,504.99</b>
--	------------	------------------	-------------------

- Made using premium JL Audio components, including two 6.5" (165 mm) speakers.
- Included weatherproof marine source unit with full color LCD display and integrated 100 watt amplifier.
- Add the 280 W Amplifier (715009229) for superior sound levels and to allow the installation of the Subwoofer & Amplifier Kit (715008094).

- Rear Speaker Kit (715009193) added to deliver superior performance.
- Not compatible with Wetsound Stealth XT 6 Can-Am Edition Sound Bar (715008282).
- Requires the Cable Cover and Roof Power Cable Kit (715010489) for installation.

<b>NEW Can-Am JL Audio Rear Speaker Kit</b>	G2, G2 MAX	<b>715009193</b>	<b>\$829.99</b>
---	------------	------------------	-----------------



- Made using premium JL Audio components, including two 6.5" (165 mm) speakers.
- Including the black speaker boxes and wiring harnesses.
- Add these to Can-Am JL Audio System – Level 2 (715009192 or 715009194) to enhance performance.

<b>NEW Can-Am JL Audio System – Level 3</b>	G2, G2 MAX	<b>715009197</b>	<b>\$2,364.99</b>
---	------------	------------------	-------------------



- Made using premium JL Audio components, including four 6.5" (165 mm) speakers (two dash and two surround speakers).
- Control your music with Bluetooth connectivity.
- Can-Am JL Audio Amplifier included (715009229) with 280 watts.
- Compatible with the pre-wired Can-Am JL Audio Subwoofer & Amplifier Kit (715008094) for quick, easy installation.

- Add the Can-Am JL Audio Roof (715009224 or 715009223) to enhance performance.
- Requires the Can-Am JL Audio Source Unit (715010002) for vehicles without 10.25" Color Touchscreen Display, installed in the center dashboard for a car-like experience.
- Requires the Cable Cover and Roof Power Cable Kit (715010489) for installation.

<b>NEW Can-Am JL Audio Roof – Level 4</b>	G2	<b>715009224</b>	<b>\$3,353.99</b>
	G2 MAX	<b>715009223</b>	<b>\$4,428.99</b>



- Full roof with premium JL Audio System.
- Weatherproof components include four (or six for MAX) 7.7" coaxial speakers and a 500-watt amplifier (MX500/4).
- Speakers include an adjustable RGB LED cone illumination, controlled via an app on your smartphone.
- Controlled by the 10.25" Color Touchscreen Display.
- Easy to install and connect.
- Included a Dome light. If you have an ACM installed, smart mode enables automatic on/off functions of the light.
- Compatible with the pre-wired Can-Am JL Audio Subwoofer & Amplifier Kit (715008094) for quick, easy installation.

- When combined with the Can-Am Audio System – Level 3 (715009197), it provides the ultimate sound experience.
- Requires the Can-Am JL Audio Source Unit (715010002) for vehicles without 10.25" Color Touchscreen Display, installed in the center dashboard for a car-like experience.
- Requires the Cable Cover and Roof Power Cable Kit (715010489) for installation.
- Not compatible with the Cargo Rack Multi-position (715009148) or Cargo Rack MAX (715009170).

<b>NEW Can-Am JL Audio Subwoofer &amp; Amplifier Kit</b>	G2, G2 MAX	<b>715008094</b>	<b>\$1,339.99</b>
--	------------	------------------	-------------------



- Orchestrated for outstanding sound quality and calibrated to enhance your audio experience.
- Makes installation a breeze by running on vehicle-specific plug-and-play wiring.
- Includes the MX300/1 amplifier fixed on the subwoofer to ease the installation.
- Designed to be tough in the most demanding riding conditions with an IP166.
- This 10" (254 mm) 300 watt under-seat subwoofer enhances both the driver's and the passenger's experience.

- Can be installed only under the passenger's seat.
- Combines with JL Audio sound system Level 2 to 4 to create the ultimate sound experience.
- Defender MAX only: A second subwoofer can be added by using the Dual Subwoofer Harness (715010858).
- Not compatible with Can-Am JL Audio System – Level 2 (with Source Unit) (715009194).

<b>NEW Can-Am JL Audio Amplifier</b>	G2, G2 MAX	<b>715009229</b>	<b>\$829.99</b>
--------------------------------------	------------	------------------	-----------------



- This is a premium JL Audio MX280/4 amplifier that is used to upgrade your Can-Am JL Audio System – Level 2 (with Source Unit) (715009194) to a 280 W system.
- Designed to be Can-Am tough in the most demanding riding conditions.
- To add a subwoofer to the Can-Am JL Audio System – Level 2 (with Source Unit) (715009194), this item is required.
- Easy to install, mounting support included.
- We've got the perfect vehicle fit for seamless integration.

<b>NEW Can-Am JL Audio Source Unit</b>	G2, G2 MAX (without touchscreen display)	<b>715010002</b>	<b>\$784.74</b>
--	--	------------------	-----------------



- Weatherproof Source Unit with Full-Color LCD Display.
- Includes a Digital AM/FM Tuner, Bluetooth® connectivity.
- The tough case (which is rated IP67) houses a 2.8-inch full-color LCD display.
- Day/Night mode to help visibility, even when it is bright outside.
- The audio output options include a strong amplifier that is built into the device. This amplifier can power your speakers with 100 watts.
- Required most Can-Am Audio JL levels installed on vehicles without 10.25" Color Touchscreen Display.

<b>NEW Dual Subwoofer Harness</b> <i>(Not illustrated)</i>	G2 MAX	<b>715010858</b>	<b>\$85.59</b>
---	--------	------------------	----------------

- Required when installing a second subwoofer (715008094) for Defender MAX.

<b>Can-Am JL Audio Roof – Level 4</b>	G1	<b>715005206</b>	<b>\$3,709.99</b>
---------------------------------------	----	------------------	-------------------



- Full roof with sleek built-in audio.
- Fully sealed and waterproof.
- Easy to install: one wire connects the roof to the vehicle's electronics.
- Four 7.7" speakers, one 280 watt amplifier, and one weatherproof source unit supplied by JL Audio¹.
- Speakers include LED lighting integrated into the grille, designed to uniformly illuminate with an RGB glow.
- A 3" full-color LCD display, with separate day/night lighting themes for visibility, even in bright sunshine.
- AM/FM tuner.
- To install the Audio Roof with the following accessories, the Power Harnesses 715003094 and 715008781 are required: Flip Glass Windshield with Wiper and Washer Kit (715002441), Windshield Wiper and Washer Kit (715001638), Front Deluxe Full Doors (715009906), Rear Deluxe Full Doors (715009907).
- Not compatible with Adventure Roof Rack or Headache Rack.
- Not compatible with 39 in. (99 cm) Double Stacked LED Light Bar (270 W) (715004007) and Light Bar Support (715006226).

<b>Can-Am JL Audio Roof – Level 4 (MAX)</b>	G1 MAX	<b>715006879</b>	<b>\$4,739.99</b>
---	--------	------------------	-------------------



- Full roof with premium JL Audio system for Defender MAX.
- Fully sealed and waterproofed components and construction.
- Simple to install: one connector connects the roof to the vehicle's electrical system.
- Weatherproof components: six 7.7" coaxial speakers, 280 watt amplifier and 70 watt Mediamaster® source unit.
- AM/FM tuner.
- Expertly tuned for exceptional sound on the move in your Defender MAX.
- Speakers include adjustable RGB LED cone illumination, controlled via an app on your smartphone.
- Mediamaster® source unit equipped with 3" full-color LCD display, with day/night lighting modes.
- Designed to not drain the battery.
- Specific to the type of riding.
- To install the Audio Roof with the following accessories, the Power Harnesses 715003094 & 715008781 are required: Flip Glass Windshield with Wiper & Washer Kit (715002441), Windshield Wiper & Washer Kit (715001638), Front Deluxe Full Doors (715009906), Rear Deluxe Full Doors (715009907).
- Not compatible with Adventure Roof Rack.
- Not compatible with 39 in. (99 cm) Double Stacked LED Light Bar (270 W) (715004007) & Light Bar Support (715006226).

### Overhead Audio System



- Rugged waterproof Jensen¹ Bluetooth Stereo Audio System offers multi-source input: AM/FM/WB and USB (iPod® and iPhone® ready).
- Convenient white LED-backlit LCD display and buttons.
- Stream from any Bluetooth-enabled device (smartphone, MP3 player).
- Powerful 4 x 40 W amplifier with remote turn-on.
- Voice-control of AVRCP-active device.
- 30 programmable AM/FM stations with auto-store/pre-set scan.
- Separate RCA audio output and input.
- UV-resistant finish/corrosion-resistant components.
- Requires Sport Roof (715002430) or Front Roof Liner (715008226) and Power Cable (715003094).

<b>Complete Overhead Audio System</b>	G1, G1 MAX	<b>715009764</b>	<b>\$1,149.99</b>
---------------------------------------	------------	------------------	-------------------

- Complete with 4 ultra-sturdy outdoor speakers (2 front and 2 rear) and 4 black speaker boxes.

<b>Overhead Front Audio System</b>	G1, G1 MAX	<b>715009765</b>	<b>\$959.99</b>
------------------------------------	------------	------------------	-----------------

- Complete with 2 ultra-sturdy front outdoor speakers and black speaker box.

<b>Wetsound Stealth XT 6 Can-Am Edition Sound Bar</b>	G1, G1 MAX, G2, G2 MAX	<b>715008282</b>	<b>\$823.99</b>
---	------------------------	------------------	-----------------



- Built-in Bluetooth connectivity with source control.
- Built-in Broadcast mode.
- Backlit control panel with Integrated LED RGB cabin lights.
- Integrated LED Dome.
- IP67 rated RF wireless remote control.
- 3.5 aux input/output.
- Built-in 300 W Class D amplifier.
- 4 marine-rated 3" full range drivers.
- 2 marine-rated 1" tweeters.
- Operating voltage: 12 V.
- IP rated: IP67.
- Length: 21.31"
- Width: 4.04"
- Height: 3.85"
- Sound Bar Mounting Kit required for installation.

<b>Can-Am JL Audio Subwoofer &amp; Amplifier Kit</b>	G1, G1 MAX	<b>715010050</b>	<b>\$1,749.99</b>
		<b>715010342</b> · Sub only	<b>\$779.99</b>



- Orchestrated for outstanding sound quality and calibrated to enhance your audio experience.
- Designed to be tough in the most demanding riding conditions.
- Easy to install, this 10" (254 mm) under-seat 250 W subwoofer enhances both the driver's and the passenger's experience.
- Includes the MX 500/1 amplifier with 715010050.
- When combined with the Can-Am Audio Roof (715005206) or with the Can-Am Audio Roof MAX (715006879), this premium JL Audio component creates the ultimate sound experience (only compatible with JL Audio Roofs).

<b>Can-Am Audio Roof Flip Kit</b>	G1, G1 MAX, G2, G2 MAX	<b>715007133</b>	<b>\$491.99</b>
-----------------------------------	------------------------	------------------	-----------------



- Combines with Can-Am Audio Roofs (715005206 & 715006879) for Flip option.
- Not compatible with the Roof Rack.

<b>Sound Bar Mounting Kit</b>	G1, G1 MAX, G2, G2 MAX	<b>715007840</b>	<b>\$52.99</b>
-------------------------------	------------------------	------------------	----------------



- Required to install the Wetsound Stealth XT 6 Can-Am Edition Sound Bar on a Defender and Defender MAX.

## ELECTRONIC ACCESSORIES

<b>NEW Front View Camera</b>	G2, G2 MAX	<b>715009408</b>	<b>\$127.79</b>
------------------------------	------------	------------------	-----------------



- Allowing clear visibility of the conditions near the front wheels.
- Helpful for avoiding obstacles before descending steep hills, when plowing or maneuvering in tight spaces.
- Offers a 170-degree viewing angle.
- Relays an image to the Touchscreen Display.
- Requires the Rear View Camera & Monitor (715009407) with models without Touchscreen Display.

<b>NEW Rear View Camera &amp; Monitor</b>	G2, G2 MAX (without touchscreen display)	<b>715009407</b>	<b>\$577.79</b>
---	--	------------------	-----------------



- Fully waterproof rearview mirror and monitor kit.
- See exactly what you need to see with the multiple camera feeds from the rear view camera.
- This unit is designed as a direct replacement for vehicles that come with a stock rearview mirror (the screen is integrated in the unit's replacement rearview mirror).
- The camera uses infrared light for night vision capabilities.
- Provides a 170-degree viewing angle.
- Designed only for models without Touchscreen Display.
- Possibility of adding the Front View Camera (715009408) for optimal vision around the vehicle.

<b>Rear View Mirror &amp; Camera Monitor</b>	G1, G1 MAX	<b>715009410</b>	<b>\$534.99</b>
--	------------	------------------	-----------------



- Fully waterproof rearview mirror and monitor kit.
- See exactly what you need to see with the multiple camera feeds from the rear view camera.
- This unit replaces the stock rearview mirror (the screen is integrated into the unit's replacement rearview mirror).
- The camera uses infrared light for night vision capabilities.

<b>NEW Power Tilt Bed</b>	G2, G2 MAX	<b>715009452</b>	<b>\$1,283.99</b>
---------------------------	------------	------------------	-------------------



- Powerful cargo box tilter with dash-integrated switch.
- Load capacity of 1,000 lb.
- Electrical actuated hydraulics for a strong and quick tilting system.

**Power Tilt Bed**

G1 (except 6x6), G1 MAX (2020 & up), G1 PRO  
G1 6x6

**715007096**

**\$1,283.99**

**715007204**

**\$1,283.99**



- Powerful cargo box tilter with dash-integrated switch.
- Electrical actuated hydraulics for a strong and quick tilting system.

**Quick Connect Battery Cable**

**715005408**

**\$11.07**



- Quickly and easily connect and charge different batteries with your charger.
- Included in the Battery Charger/Maintainer.
- Sold individually.

**Quick Connect Cable with Battery Indicator**

**715006055**

**\$23.99**



- Quickly and easily connect and charge different batteries with your charger.
- 3-color LED indicator provides constant battery health indication.
- Sold individually.

**Cellphone Holder**

G1, G1 MAX, G2, G2 MAX

**715008786**

**\$106.99**



- Water resistant door allows for perfect phone positioning.
- Features capacitive and resistive touch screen technology.
- Spring system in back plate automatically adjusts for thickness.
- Fits all cellphones within 7.2" (185 mm) x 3.3" (85 mm) x 0.6" (15 mm) dimensions.
- Works with almost all charger wires.
- Does not include cellphone or charging wires.
- Requires the RAM GPS Mount (715003325) bolted directly on the dashboard for the Cellphone Holder to be supported. Can be installed with the LinQ Lite Device Holder (715009201).

**RAM GPS Mount**

G1, G1 MAX, G2, G2 MAX

**715003325**

**\$70.99**



- Allows for GPS integration onto vehicle.
- Standard AMPS hole pattern for Garmin Cradle.

**Digitally Encoded Security System (D.E.S.S.™) Keys**

G1, G1 MAX (2023 & prior), G1, G1 MAX (2024 & up with HD9 & HD10 engine)

**715002458**

**\$84.99**



- Top-security anti-theft protection for your vehicle.
  - Encrypted chip technology restricts access to your vehicle's electronic ignition system.
  - One vehicle/one code.
  - A vibration/shock-resistant ball-and-socket design that ensures a reliable connection.
- 3 programmable modes:
- Work mode: configurable vehicle speed limit between 20 km/h (13 mph) and 100 km/h (60 mph) that does not limit engine torque (G1 HD7, HD8). Limits vehicle speed to 40 km/h (25 mph) but does not limit engine torque (G1 HD9, HD10).
  - Normal mode: configurable, limits vehicle speed to 70 km/h (44 mph) and may have torque reduction.
  - Performance mode: No restrictions.

<b>Digitally Encoded Security System (D.E.S.S.) Keys</b>	G1 (2024 & up with HD7 engine)	<b>715009300</b>	<b>\$84.99</b>
--	--------------------------------	------------------	----------------



- Top-security anti-theft protection for Can-Am vehicles.
  - The encrypted chip technology restricts access to the unit's electronic ignition system.
  - One code per vehicle.
  - Features a vibration/shock-resistant ball-and-socket design that ensures a reliable connection.
- Comes with three programmable keys, including:
    - Work key: configurable vehicle speed limit between 20 km/h (13 mph) and 100 km/h (60 mph) that does not limit engine torque.
    - Normal key: configurable, limits vehicle speed to 70 km/h (44 mph) and may have torque reduction.
    - Performance key: no restrictions.

<b>Digitally Encoded Security System (D.E.S.S.) Green Key</b>	G2, G2 MAX	<b>710005232</b>	<b>\$63.49</b>
---	------------	------------------	----------------



- Top-security anti-theft protection for your vehicle.
  - Encrypted chip technology restricts access to your vehicle's electronic ignition system.
  - One vehicle/one code.
  - A vibration/shock-resistant ball-and-socket design that ensures a reliable connection.
- 3 programmable modes:
    - Work mode: configurable vehicle speed limit between 20 km/h (13 mph) and 100 km/h (60 mph) that does not limit engine torque.
    - Normal mode: configurable, limits vehicle speed to 70 km/h (44 mph) and may have torque reduction.
    - Performance mode: no restrictions.

<b>NEW Auxiliary Battery Installation Kit</b>	G2, G2 MAX	<b>715009473</b>	<b>\$246.09</b>
---	------------	------------------	-----------------



- Allows you to add a second 32 Ah battery for a dual battery setup that will give you the extra juice you need to power auxiliary electrical components like a sound system or winch.
- Kit includes all necessary wiring and the battery holder.
- Additional battery sold separately (710008836).
- Requires Center Underseat Storage Bin (715009199).

<b>Auxiliary Battery Installation Kit</b>	G1, G1 MAX (2020 & up)	<b>715006035</b>	<b>\$417.49</b>
---	------------------------	------------------	-----------------



- Allows you to add a second 30 Ah battery for a dual battery setup that will give you the extra juice you need to power auxiliary electrical components like a sound system or winch.
  - Additional battery sold separately (515176151).
- Equipped with an integrated smart battery isolator that will prevent your auxiliary electrical components from draining your starting battery.
  - Kit includes an additional battery junction block, all necessary wiring and the battery holder.

<b>USB Power Outlet Kit</b>	G1, G1 MAX (2020 & up)	<b>219400510</b>	<b>\$42.99</b>
-----------------------------	------------------------	------------------	----------------



- Recharges your electronic devices while riding\* (smartphone, MP3, heating gear, etc.).
- Dual port USB connectors.

*\*The power outlet is not capable of recharging all device types while riding.*

<b>NEW Defrost, Heat &amp; Ventilation System</b>	G2, G2 MAX	Coming Soon
---	------------	-------------



- Ventilation system design and vehicle integration have been rethought to significantly improve installation time.
  - Best integrated in-dash system on the market with 3 fan speeds and adjustable temperature.
  - Mode dial lets you choose between 5 airflow selections.
  - Adjustable/directional vents can be closed to concentrate heat toward specific areas.
  - A total of 10 vents specially positioned for windshield, window defrost and occupant heating.
- Easy-to-service air filter.
  - Includes the replacement lower dashboard compatible with the heating system.
  - For MAX models, you can add the Rear Passenger Heater Vents for rear passengers' comfort.
  - If the vehicle is not already equipped with a cab, Cable Cover and Roof Power Cable Kit (715010489) is required for window defrost.

<b>NEW Rear Passenger Heater Vents</b>	G2 MAX	Coming Soon
--	--------	-------------



- Situated on the floor to allow the heated air to circulate effectively to the rear seats.
- Adjustable/directional vents can be closed to concentrate heat toward specific areas.
- There are two vents that are designed to help keep rear passengers cozy.
- Requires the Defrost, Heat & Ventilation System.

<b>Defrost, Heat &amp; Ventilation System</b>	G1, G1 MAX 2019 & prior (not compatible with HD5 Motorization)	<b>715004917</b>	<b>\$1,625.99</b>
---	---	------------------	-------------------

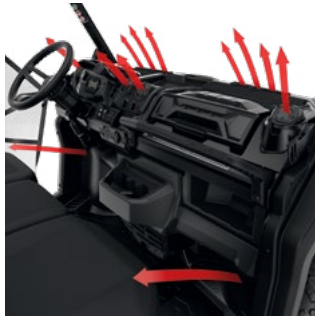

- Best integrated system on the market with 3-ventilation speeds and in-dash adjustable temperature.
- Adjustable/directional vents.
- 10 vents specially positioned for better windshield and side window defrosting/deicing, foot and hand heat.
- Easy-service air filter.
- Once installed, you might want to add storage space with the Lower Dashboard for Heating System and Dash Storage Compartment Net for Heating System.

G1, G1 MAX 2020 (except G1 PRO & HD5 models)	<b>715005904</b>	<b>\$1,741.49</b>
G1, G1 MAX (2021 & up)	<b>715008093</b>	<b>\$1,762.99</b>

- Best integrated in-dash system on the market with 3 fan speeds and adjustable temperature.
- Adjustable/directional vents can be closed to concentrate heat at specific areas.
- A total of 8 vents specially positioned for windshield and occupant heating.
- Easy-to-service air filter.
- Includes the replacement lower dashboard compartment for the heating system.
- Dash Storage Compartment Net for Heating System is recommended.

<b>Heated Seat</b>	G1, G1 MAX, G2, G2 MAX	<b>715006112</b>	<b>\$144.99</b>
--------------------	------------------------	------------------	-----------------

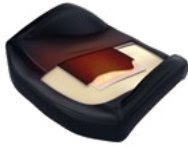

- 25 W seat heater delivers chill-free riding comfort.
- High/low temperature settings allow you to control the desired degree of warmth.
- This kit includes one carbon fiber seat heater, foam sheet and in-dash switch.
- Installs directly in the original seat cushion.
- Heated Accessories Wiring Harness ( 710005757 or 710006036) is required for installation on front seat.
- Heated Accessories Wiring Harness (715006004) is required for installation on rear seats on MAX models.

<b>Heated Seat Harness for Front Seat</b> <i>(Not illustrated)</i>	G1, G1 MAX (models with Defrost, Heat & Ventilation System), All Defender PRO models	<b>710006036</b>	N/A
	G1, G1 MAX (models without Defrost, Heat & Ventilation System), G2, G2 MAX	<b>710005757</b>	<b>\$127.99</b>

- Electric harness required to hook up and operate heated accessories.
- Powers up to 4 accessories: 2 hand accessories (grab bar/steering wheel) and 2 seat covers.

<b>Heated Seat Harness for Rear Seat</b> <i>(Not illustrated)</i>	G1 MAX, G2 MAX	<b>715006004</b>	<b>\$189.99</b>
--	----------------	------------------	-----------------

- Electric harness required to hook up and operate rear heated seats.

<b>Heated Visor Outlet</b>	G1, G1 MAX	<b>715001246</b>	<b>\$60.99</b>
----------------------------	------------	------------------	----------------



- Strategically positioned on vehicle to maintain your agility.
- Optional visor outlet that delivers fog-free riding.
- Quick and easy installation.
- Sold individually.
- Heated Visor not included.

# WINCHES & HITCHES

## CAN-AM HD WINCHES

<b>Can-Am HD 4500 Winch</b>	G1, G1 MAX, G2, G2 MAX	<b>715006416</b>	<b>\$384.99</b>
-----------------------------	------------------------	------------------	-----------------



- Ergonomic clutch handle.
- Rugged all-steel gears and bushings for more torque and durability.
- Automatic 100% load-holding brake.
- Sealed solenoid for all-weather protection.
- Weather sealed corded remote and dash mounted switch.
- EC compliant.
- Pulling strength capability of 4,500 lb (2,041 kg).
- 43' of 1/8" (13.1 m of 6.3 mm) steel wire cable.
- Heavy-duty 4-way roller fairlead.
- Winch Electrical Harness (715007078) is required for installation on a Defender 2021 and prior. Winch Electrical Harness (715008152) is required for installation on a Defender Base and DPS™ 2022 and up.

<b>Can-Am HD 4500-S Winch</b>	G1, G1 MAX, G2, G2 MAX	<b>715006417</b>	<b>\$513.49</b>
-------------------------------	------------------------	------------------	-----------------



- Ergonomic clutch handle.
- Rugged all-steel gears and bushings for more torque and durability.
- Automatic 100% load-holding brake.
- Sealed solenoid for all-weather protection.
- Weather sealed corded remote and dash mounted switch.
- Pulling strength capability of 4,500 lb (2,041 kg).
- 50' of 1/4" (15.2 m of 6.35 mm) synthetic rope.
- Corrosion-proof aluminum Hawse fairlead.
- Winch Electrical Harness (715007078) is required for installation on a Defender 2021 and prior. Winch Electrical Harness (715008152) is required for installation on a Defender Base, DPS, DPS Cab 2022 and up.

<b>Cargo Bed Winch</b>	G2, G2 MAX	<b>715009419 NEW</b>	<b>\$834.59</b>
	G1, G1 MAX	<b>715006355</b>	<b>\$716.99</b>



- Allows you to pull heavy loads into the cargo box easily.
- Perfect for hunting applications when it comes to loading game.
- Includes support base made of heavy-duty 2" (5 cm) steel tubing, winch and weather-sealed corded remote.
- 750 lb (340 kg) maximum pulling capacity.
- Electronic security module to prevent vehicle damage that could occur if loaded vehicle exceeds manufacturer's gross weight rating.
- Adapter Kit (715004709) is required for installation with Gear Rail Adapter (715003392).
- Defender 6x6 and PRO: Requires Power Tilt Bed (715009338).

<b>NEW Winch Cable Stopper</b>	All Can-Am HD Winches	<b>715009921</b>	<b>\$21.29</b>
--------------------------------	-----------------------	------------------	----------------



- Made of EPDM, a highly durable synthetic rubber.
- The Winch Cable Stopper isn't just for looks. It helps extend the life of the winch, rope, hook, and fairlead.
- In addition, the split design makes it easy to install.

<b>Synthetic Winch Cable*</b>	Can-Am HD Winch	<b>715006430</b>	<b>\$158.99</b>
	WARN Winch	<b>715007783</b>	<b>\$169.99</b>



- 50' of 1/4" (15.2 m of 6.35 mm) synthetic cable for WARN winch.
- WARN Hawse Fairlead is required when upgrading to a synthetic cable to avoid damage and premature wear of the cable.

*\*Ask your dealer or visit [canamoffroad.com](http://canamoffroad.com) for price details.*

<b>Replacement Wire Rope*</b>	Can-Am HD Winch	<b>705014978</b>	<b>\$23.99</b>
	WARN Winch	<b>715006699</b>	<b>\$82.99</b>



- 43' of 1/8" (13.1 m of 6.3 mm) wire rope.
- 4,500 lb (2,041 kg) pulling strength.

*\*Ask your dealer or visit [canamoffroad.com](http://canamoffroad.com) for price details.*

<b>Synthetic Cable Extension</b>		<b>715001120</b>	<b>\$174.99</b>
----------------------------------	--	------------------	-----------------



- Lightweight 1/4" (6.35 mm) diameter, easy to handle and won't rattle in cargo box.
- Easily attaches to winch cable to provide additional 50' (15.2 m) of distance.
- 4,500 lb (2,041 kg) single line capacity.

<b>WARN Hawse Fairlead*</b>	With WARN winch	<b>715007785</b>	<b>\$114.99</b>
	<ul style="list-style-type: none"> <li>• Double-powder-coated construction.</li> <li>• Required to use the Synthetic Winch Cable (715007783) on WARN winches.</li> <li>• To be used with synthetic winch cables only.</li> </ul>		
<b>Can-Am HD Hawse Fairlead</b>	With Can-Am HD winch	<b>715006426</b>	<b>\$61.49</b>
	<ul style="list-style-type: none"> <li>• A must when upgrading your winch with a synthetic cable, this corrosion-proof aluminum Hawse fairlead will prevent the cable from snapping in a corner of a roller fairlead and from wearing prematurely due to the rough surface of the worn roller guide.</li> <li>• Must be used with synthetic cables only.</li> </ul>		
<b>Roller Fairlead</b>	With Can-Am HD winch	<b>710007082</b>	<b>\$59.49</b>
	<ul style="list-style-type: none"> <li>• Suggested when changing the wire rope.</li> <li>• Heavy-duty replacement fairlead for winches.</li> </ul>		
<b>NEW Wireless Winch Remote</b>	With Can-Am HD Winch	<b>715008286</b>	<b>\$159.74</b>
	<ul style="list-style-type: none"> <li>• On/Off and Winch In / Winch Out buttons with LED indicator light.</li> <li>• Large Winch In / Winch Out buttons for easy activation with gloves.</li> <li>• Ergonomic remote handle shape with a trigger-like holding protrusion.</li> <li>• Quick and easy to install, thanks to a wiring harness with an integrated antenna and all necessary mounting hardware.</li> <li>• Allows you to operate your winch from anywhere within a 50' (15.2 m) radius, increasing your recovery options.</li> <li>• All components are IP67 sealing rated.</li> <li>• The remote also floats in case it's dropped during a deep water recovery.</li> <li>• Dash and handlebar mounting options.</li> <li>• Compatible with all Can-Am HD winches.</li> </ul>		
<b>Wired Remote Control</b>	With Can-Am HD winch	<b>715006504</b>	<b>\$26.49</b>
	<ul style="list-style-type: none"> <li>• This kit allows winch owners to add the hand-held remote to vehicles with a stock winch.</li> <li>• Works in conjunction with the mini-rocker switch.</li> <li>• Remote control and connection socket are included with Can-Am HD winch.</li> <li>• EC compliant.</li> </ul>		
<b>NEW Trailer Hitch Ball Mount</b>	G1, G1 MAX, G2, G2 MAX	<b>715010023</b>	<b>\$85.19</b>
	<ul style="list-style-type: none"> <li>• Designed to fit trailer hitches with a 2" x 2" (5 cm x 5 cm) receiver tube opening.</li> <li>• It offers 3,500 lb (1,590 kg) of towing capacity.</li> <li>• Solid forged steel construction.</li> <li>• Equipped with a hole to accept a 3/4" (1.9 cm) ball shank.</li> <li>• 1" (2.5 cm) raised or 2" (5 cm) lowered for precise trailer leveling.</li> <li>• Hitch ball not included.</li> </ul>		
<b>Lower Front Receiver Hitch</b>	G1, G1 MAX	<b>715002519</b>	<b>\$127.49</b>
	<ul style="list-style-type: none"> <li>• Heavy-duty 1,500 lb (680 kg) towing capacity, 2" (5 cm) receiver hitch.</li> <li>• Expand and enhance functionality by pairing it with Higher Front Receiver Hitch and Removable Winch Mounting Kit (need to relocate winch from its standard mounting position).</li> </ul>		
<b>Higher Front Receiver Hitch</b>	G1, G1 MAX (except Limited models)	<b>715003109</b>	<b>\$138.49</b>
	<ul style="list-style-type: none"> <li>• Heavy-duty 1,500 lb (680 kg) towing capacity, 2" (5 cm) receiver hitch.</li> <li>• No need to relocate winch from its standard mounting position.</li> </ul>		

<b>Winch Electrical Harness</b> <i>(Not illustrated)</i>	G1, G1 MAX (2019 & prior)	<b>715003093</b>	<b>\$61.99</b>
	G1, G1 MAX (2020 & 2021)	<b>715007078</b>	<b>\$127.99</b>
	G1, G1 MAX 2022	<b>715008152</b>	<b>\$117.49</b>

- Required to install a winch on a Defender without a factory-installed winch.

<b>Rubber Receiver Plug</b>	<b>705204503</b>	<b>\$13.81</b>
-----------------------------	------------------	----------------



- Rubber cap for 2" (5 cm) Receiver Hitch.

# PERFORMANCE

<b>Performance Half Shaft</b>	G1, G1 MAX (2019 & prior – except X mr, XT-P and XT CAB 2018-2019)	<b>705402353</b>	<b>\$243.99</b>
	G1, G1 MAX XT Cab 2018-2019, Lone Star Edition 2019 & prior	<b>705402575</b>	<b>\$243.99</b>



- High-performance design ideal for off-road use, with superior wheel power and acceleration for racing, dunes and desert riding.
- Includes CVs, shaft and boots with the best suited geometry for your Can-Am vehicle.

<b>Brake Holding Mechanism</b>	G1, G1 MAX	<b>715004733</b>	<b>\$180.99</b>
--------------------------------	------------	------------------	-----------------



- Maintains constant pressure on the brake pedal to keep the vehicle from moving on sloped terrain, without having to put the transmission in P (park).

<b>Heavy-Duty Spring Kit</b>	G1, G1 MAX 62" with Double A-Arm Front Suspension	<b>715005084</b>	<b>\$308.99</b>
------------------------------	---	------------------	-----------------



- This set of heavy-duty springs will stiffen your suspension.
- Perfect for reducing overall vehicle sag when shocks are under heavy demand: heavy loading and hauling or for snow clearing.
- Complete kit of 4 springs.
- Not compatible with Defender HD5, HD10, XT CAB, Mossy Oak Edition & X mr models and Defender MAX.

<b>NEW Magneto Stator Kit (1,700 Watt)</b>	G2, G2 MAX (with HD11 engine only)	<b>715009450</b>	<b>\$1,612.49</b>
--	------------------------------------	------------------	-------------------



- Increases the magneto output to 1,700 W.
- Includes rotor, stator and regulator.
- Improves charging when several accessories are installed.
- Standard on HVAC models.

<b>850 W Magneto Kit</b>	G1, G1 MAX (2020 & up except HD5 & HD7)	<b>715007122</b>	<b>\$798.49</b>
--------------------------	---	------------------	-----------------



- Increases the magneto output to 850 W.
- Includes rotor, stator and regulator.

<b>Emergency Kit</b>	<b>715006102</b>	<b>\$170.49</b>
----------------------	------------------	-----------------



- Complete emergency kit provides all essential equipment and supplies to get out of most unfavorable situations powersport enthusiasts can find themselves in.
- Includes: jumper cables, air compressor, tire repair kit, first aid kit, ratchet tie-down, duct tape, 3,300 lb (1,500 kg) tow strap, zip ties, cloth rags.

## AIR INTAKES

<b>NEW Snorkel Kit</b> <i>(Not illustrated)</i>	G2, G2 MAX	<b>715009151</b>	<b>\$638.99</b>
--	------------	------------------	-----------------

- Raises point of engine and CVT air intakes so vehicle can be semi-submersed in water/mud without taking in water to the engine.
- Not compatible with Rear Glass Window (715007079), Rear Glass Window with Sliding Panel (715007080), Headache Rack (715009171), Bed Wall Extender (715009166, 715009590 & 715010833).
- Standard on Defender X mr models.
- Not compatible with cab models.

<b>Snorkel Kit</b>	G1, G1 MAX 2018 & up (except HD5, HD7, Limited and PRO)	<b>715003727</b>	<b>\$787.49</b>
--------------------	---	------------------	-----------------



- Raises point of engine and CVT air intakes so vehicle can be semi-submersed in water/mud without taking in water to the engine.
- Not compatible with Headache Racks, Gear Rail equipment, DragonFire Cargo Bed Roll Bar and Windshield Wiper & Washer Kit.
- Snorkel Extension Kit is available for roof level air intake and CVT exhaust.
- Standard on Defender X mr models.

<b>Sealed Air Box</b> <i>(Not illustrated)</i>	G1, G1 MAX (2017 & prior)	<b>707801033</b>	<b>\$184.99</b>
---	---------------------------	------------------	-----------------

- Required when installing the Snorkel Kit (715003727) on Defender and Defender MAX 2017 and prior models.
- Standard on Defender 2018 and up models.

<b>Snorkel Pre-Filter</b>	G1, G1 MAX (except PRO models)	<b>715005597</b>	<b>\$104.99</b>
---------------------------	--------------------------------	------------------	-----------------



- Pre-filter specifically for snorkels.
- Adds extra protection to your engine in harsh riding conditions.
- Helps keep air filter cleaner.
- Filter blocks particles larger than 0.005" (0.13 mm).
- Necessary to maintain vehicle warranty when tracks are installed for winter use.
- For Defender HD10 models 2020 & up: Replace CVT intake of snorkel kit with CVT relocation kit 715008651 or 703501211.

<b>Air Intake Pre-Filter</b>	G1 (except X mr models), G1 MAX	<b>715003483</b>	<b>\$54.99</b>
------------------------------	---------------------------------	------------------	----------------



- Adds extra protection to your engine in harsh riding conditions.
- Helps keep air filter cleaner.
- Filter blocks particles larger than 0.007" (0.19 mm).
- Easy, tool-less installation.
- Necessary to maintain vehicle warranty when tracks are installed.
- Required to install the Apache and Backcountry Track Systems.
- Not compatible with Snorkel Kit.

<b>Foam Air Filter by Twin AIR<sup>†</sup></b>	G1, G1 MAX	<b>715003630</b>	<b>\$126.99</b>
--	------------	------------------	-----------------



- The best choice for the harshest conditions.
- Multiple staged oiled filtering foam for superior dust retaining capacity with high air flow.
- Washable and reusable.

<b>CVT Auxiliary Intake &amp; Pre-Filter Kit</b>	G1, G1 MAX (without Snorkel Kit)	<b>703501210</b>	<b>\$204.99</b>
	G1, G1 MAX (X mr models or models with Snorkel Kit)	<b>703501211**</b>	<b>\$196.99</b>



- The CVT Auxiliary Intake & Pre-Filter Kit is MANDATORY for track-equipped 2020 to 2022 and some 2023<sup>†</sup> Defender HD10 models used in snow conditions and highly recommended for other models.
- This kit is sold separately.

<sup>†</sup>Comes from the factory on some MY23; inspect the vehicle to confirm.

Mandatory on all MY20 and up Defender HD10 models equipped with a snorkel.

\*\*When installed on X mr models or models with Snorkel Kit, it temporarily relocates CVT air intake to the standard factory location.

No traction? No problem. Apache XC Tracks are built for serious terrain. With improved flotation and stability, they tackle deep snow, mud, and everything in between. Engineered for optimized attack angles, reduced noise, and unmatched durability, this system means all-season dominance.

# DESIGNED FOR PEAK PERFORMANCE

Aggressive lugs deliver max traction without sacrificing handling. A reinforced steel frame boosts strength, while the center slide improves alignment and reduces de-tracking. Reduced NVH levels and the wheel placement ensure smooth, quiet power delivery. Plus, wheel longevity is increased with replaceable wheel bearings.



## APACHE TRACK SYSTEMS

### APACHE XC LT LIMITED WARRANTY\*

<b>Apache XC LT Track System</b>	G1, G1 MAX, G2, G2 MAX (except 6x6)	<b>715007719</b>	<b>\$6,899.99</b>
----------------------------------	-------------------------------------	------------------	-------------------



- Long Track version.
- Brand-new track design to optimize driving off-road and in deep snow conditions.
- Reduction in steering effort thanks to the 4-wheel tandem.
- Improved steering precision from optimized wheel and track rolling band alignment.
- 1.25" (3.175 cm) lugs in the front and in the back for better traction and lateral stability.
- Track width: front 12.5" and rear 15".
- Adds 3" (7.62 cm) of ground clearance versus 27" tires.
- Additional shaft dampers, tandem dampers, track design and wheel layout significantly reduce NVH (noise vibration harshness).
- Central guide for optimized track alignment and reduced occurrences of detracking.
- Optimized track layout with increased angle of attack for better obstacle crossing and snow performance.
- Stamped and welded steel frame for improved strength and durability.
- Easy maintenance with replaceable hub and wheel bearings.
- Main hub has oil bath and 3 bearings for consistent lubrication and improved durability.
- Mounting kit sold separately.
- See table for fit, compatibility and requirements.

<b>Apache XC LT Mounting Kit</b>		<b>715006891</b>	<b>\$701.99</b>
	G1, G1 MAX (except 6x6)	<b>715008612</b>	<b>\$701.99</b>
	G2, G2 MAX (except 6x6)	<b>715009252 NEW</b>	<b>\$794.23</b>



- Required for installation of the Apache XC LT Track System.
- DPS module and Engine Pre-Filter not included.
- The CVT Auxiliary Intake & Pre-Filter Kit is MANDATORY for track-equipped 2020 and up Defender HD10 models used in snow conditions and highly recommended for other models.\*
- This kit is sold separately.
- See table for fit, compatibility and requirements.

\*Comes from the factory on some 2023 and up models, inspect the vehicle to confirm. Mandatory on all 2020 and up Defender HD10 models equipped with a snorkel.

\*The limited warranty is subject to the exclusions, limitations of liabilities and all other terms and conditions of BRP's standard limited warranty.

## APACHE BACKCOUNTRY

## LIMITED WARRANTY\*

### Apache Backcountry LT Track Kit

G1, G1 MAX (except 6x6)

**715005891**

**\$8,549.99**

G2, G2 MAX (except 6x6)

**715004734**

**\$8,549.99**



- Tracks designed to deliver the best snow performance on the market with unmatched flotation level and traction on snow surface.
- Large contact patch, 37% bigger than the Apache 360 LT.
- Impressive added ground clearance of 7" (18 cm) helps keep the vehicle over the snow.
- Lightweight snowmobile-inspired rail design.
- Aggressive track design with 2" (5 cm) lug height for maximum traction on snow.
- Apache Backcountry LT Mounting Kit, Track DPS Module and Engine Pre-Filter are required and sold separately.

- The CVT Auxiliary Intake & Pre-Filter Kit is MANDATORY for track-equipped 2020 to 2022 and some 2023' Defender HD10 models and highly recommended for other models. This kit is sold separately.
- For winter use only.
- Track installation will affect vehicle width and length.
- Fine-tune your track system using extra Idler Wheels, Sliders with Vespel Inserts and Rail Ice Scratcher.

*\*Comes from the factory on some MY23, inspect the vehicle to confirm.*

*Mandatory on all MY20 and up Defender HD10 models equipped with a snorkel.*

### Apache Backcountry LT Mount Kit

(Not illustrated)

See table for fit, compatibility and requirements.

**715009932 NEW**

**\$842.39**

**715005888**

N/A

**715005493**

**\$593.49**

**715006196**

N/A

- Required for installation of the Apache Backcountry Track LT System.
- DPS Module and Engine Pre-Filter are required and sold separately.
- The CVT Auxiliary Intake & Pre-Filter Kit is MANDATORY for track-equipped 2020 to 2022 and some 2023' Defender HD10 models and highly recommended for other models. This kit is sold separately.

*\*Comes from the factory on some MY23, inspect the vehicle to confirm.*

*Mandatory on all MY20 and up Defender HD10 models equipped with a snorkel.*

## APACHE 360

## LIMITED WARRANTY\*

### Apache 360 LT Track System

Defender, Defender MAX (except 6x6)

**715005103**

**\$6,729.99**



- Multifunctional tracks designed to support heavy loads and to fit on most Can-Am off-road vehicles.
- Extra contact patch adjustment for better performance over rough terrain.
- Contact patch is 7 to 9% bigger than the Apache 360's.
- Average ground clearance of 16" (41 cm). 1" (2.5 cm) lugs in the front and 1.25" (3.2 cm) in the back.
- EC compliant.
- Apache 360 LT Mounting Kit, Track DPS Module and Engine Pre-Filter Kit are required and sold separately.

- The CVT Auxiliary Intake & Pre-Filter Kit is MANDATORY for track-equipped 2020 to 2022 and some 2023' Defender HD10 models used in snow conditions and highly recommended for other models. This kit is sold separately.

*\*Comes from the factory on some MY23, inspect the vehicle to confirm.*

*Mandatory on all MY20 and up Defender HD10 models equipped with a snorkel.*

### Apache 360 LT Mounting Kit

(Not illustrated)

See table for fit, compatibility and requirements.

**715004832**

**\$506.99**

- Required for installation of the Apache 360 LT Track System.
- DPS module and Engine Pre-Filter not included.
- The CVT Auxiliary Intake & Pre-Filter Kit is MANDATORY for track-equipped 2020 to 2022 and some 2023' Defender HD10 models used in snow conditions and highly recommended for other models.

- This kit is sold separately.

*\*Comes from the factory on some MY23, inspect the vehicle to confirm.*

*Mandatory on all MY20 and up Defender HD10 models equipped with a snorkel.*

## APACHE ACCESSORIES

### Track DPS Module

(Not illustrated)

See table for fit, compatibility and requirements.

**715006266**

**\$111.49**

**715007338**

**\$111.49**

- An innovative DPS module that ensures speedometer accuracy and optimized steering assist, which make for perfect track control and riding ease.
- Required to install the Apache and Backcountry Track Systems.

### Rail Ice Scratchers

Apache Backcountry and Backcountry LT Track Systems

**860201728**

**\$127.99**



- Provide additional lubrication in hard and icy conditions and extend slider life.
- Rail mounted, small, light.
- Design expands on coil concept to allow reversing without damage.
- Easily stored when not in use.



- Additional wheel kit for Backcountry LT rear tracks.
- Reduces drag and rolling resistance in hard snow conditions or when transporting heavier loads.
- Extends slider life in hard snow conditions.
- Includes two wheels, cross shaft and mounting hardware per kit to service one track corner.
- Up to two kits per rear track can be installed.

## APACHE TRACK SYSTEMS FITTING GUIDE

### APACHE XC LT

Model Year	Generation	Front Suspension Type	Track	Track Mount	Track DPS Module	CVT Pre-Filter	Engine Pre-Filter
2024 & Prior	G1	Double A-Arm	715007719	715006891	715007338	703501210 (w/o Snorkel Kit) 703501211 (w/ Snorkel Kit)	715003483 (w/o Snorkel Kit) 715005597 (w/ Snorkel Kit)
2020 to 2022	G1	Arched Double A-Arm without Swaybar		715008612			
2023 & Up	G1	Arched Double A-Arm with and without Swaybar					
2024 & Up	G1	Double A-Arm		715006891	715006266		
2026	G2	Arched Double A-Arm with Swaybar		715009252		Not Required	Not Required

### APACHE BACKCOUNTRY LT

Model Year	Generation	Front Suspension Type	Track	Track Mount	Track DPS Module	CVT Pre-Filter	Engine Pre-Filter
2024 & Prior	G1	Double A-Arm	715005891	715005888	715007338	703501210 (w/o Snorkel Kit) 703501211 (w/ Snorkel Kit)	715003483 (w/o Snorkel Kit) 715005597 (w/ Snorkel Kit)
2025 & Prior	G1	Arched Double A-Arm with Swaybar		715006196			
2020 & Up	G1	Arched Double A-Arm without Swaybar		715005493			
2024 & Up	G1	Double A-Arm		715005888	715006266		
2026	G2	Arched Double A-Arm with Swaybar		715004734		715009932	Not required

### APACHE 360 LT

Model Year	Generation	Front Suspension Type	Track	Track Mount	Track DPS Module	CVT Pre-Filter	Engine Pre-Filter
2018 to 2022	G1	Arched Double A-Arm with Swaybar	715005103	715004832	715007338	703501210 (w/o Snorkel Kit) 703501211 (w/ Snorkel Kit)	715003483 (w/o Snorkel Kit) 715005597 (w/ Snorkel Kit)

\*The limited warranty is subject to the exclusions, limitations of liabilities and all other terms and conditions of BRP's standard limited warranty.

Defender G2 models now come plow-ready, no mounting plate required. The push frame mounts directly to the chassis for quick setup and maximum pushing power. From the season's first snowfall to the last cleanup, they're designed to deliver powerful, precise performance every time.

# DEFENDER G2: READY TO PLOW AND PUSH HARD

Start with a blade and push frame, then dial it in with accessories like edge markers, a plow angling system, and drift cutters. Easy to install, engineered to last, and tough enough for winter jobs—this lineup covers every plowing need.



## PROMOUNT PLOWS

### CAN-AM ProMount FLEX2 PLOW KIT

Can-Am ProMount Flex2 72" (183 cm) Blade Plow Kit	G1, G1 MAX	715008170	\$1,465.97
	G2, G2 MAX	715009134 <b>NEW</b>	N/A



- These kits include:
  - Can-Am ProMount Flex2 Blade.
  - Push Frame with Quick-Attach System.
  - Mounting Plate (G1 models only).

### CAN-AM ProMount FLEX2 BLADES

Can-Am ProMount Flex2 66" (168 cm) Blade	Fits ProMount Push Frame	715009883	\$598.99
--	--------------------------	-----------	----------



- Plow blade made of UHMWPE, flexible and impact absorbing material prevents damaging your plow when accidental impact occurs.
- Replaceable wear blade.
- Large pin designed for easy blade rotation to eliminate snow buildup at pivot point.
- Blade design provides best snow roll-off at any angle.
- Clears 60" (152 cm) when plow is fully angled.
- Blade height of 17" (43 cm).
- Compatible with Can-Am ProMount Blade accessories to further enhance plow versatility.

Can-Am ProMount Flex2 72" (183 cm) Blade	Fits ProMount Push Frame	715009868	\$684.99
--	--------------------------	-----------	----------



- Plow blade made of UHMWPE, flexible and impact absorbing material prevents damaging your plow when accidental impact occurs.
- Replaceable wear blade.
- Large pin designed for easy blade rotation to eliminate snow buildup at pivot point.
- Blade design provides best snow roll-off at any angle.
- Clears 66" (168 cm) when plow is fully angled.
- Blade height of 17" (43 cm).
- Compatible with Can-Am ProMount Blade accessories to further enhance plow versatility.

## CAN-AM ProMount STEEL PLOW KIT

Can-Am ProMount Steel 72" (183 cm) Blade Plow Kit	G1, G1 MAX	■ 715008172	\$1,390.97
	G2, G2 MAX	■ 715009135 <b>NEW</b>	N/A



- These kits include:
  - Can-Am ProMount Steel Blade
  - Push Frame with Quick-Attach System
  - Mounting Plate (G1 models only).

## CAN-AM ProMount STEEL BLADES

Can-Am ProMount Steel 66" (168 cm) Blade	Fits ProMount Push Frame	■ 715009881 • Black	\$534.99
--	--------------------------	---------------------	----------



- Plow blade made from 12-gauge steel.
- Replaceable wear blade.
- Large pin designed for easy blade rotation to eliminate snow buildup at pivot point.
- Blade design provides best snow roll-off at any angle.
- Clears 60" (152 cm) when plow is fully angled.
- Blade height of 17" (43 cm).
- Compatible with Can-Am ProMount Blade accessories to further enhance plow versatility.
- Not compatible with S3 High Clearance Front A-Arm.

Can-Am ProMount Steel 72" (183 cm) Blade	Fits ProMount Push Frame	■ 715009877 • Black	\$609.99
--	--------------------------	---------------------	----------



- Plow blade made from 12-gauge steel.
- Replaceable wear blade.
- Large pin designed for easy blade rotation to eliminate snow buildup at pivot point.
- Blade design provides best snow roll-off at any angle.
- Clears 66" (168 cm) when plow is fully angled.
- Blade height of 17" (43 cm).
- Compatible with Can-Am ProMount Blade accessories to further enhance plow versatility.
- Not compatible with S3 High Clearance Front A-Arm.

## ProMount PLOW KITS – REFERENCE CHARTS

	DEFENDER G1				DEFENDER G2	
	66" Black Steel	66" Flex2	72" Black Steel	72" Flex2	72" Flex2	72" Black Steel
Plow Kit	-	-	715008172	715008170	715009134	715009135
Blade	715009881	715009883	715009877	715009868	715009868	715009877
Push Frame	715008116	715008116	715008116	715008116	715008888	715008888
Mounting Plate	715007745	715007745	715007745	715007745	-	-

## CAN-AM ProMount ANGLE PLOWS

Can-Am ProMount 66" (168 cm) Steel Oneway State Blade	Fits ProMount Push Frame	715007263	\$619.99
---	--------------------------	-----------	----------



- Make the job easier with the right tools, clear long alleys and make the task easier by sending the snow further out of the way.
- Wing end of plow measures 26" (67 cm) high and tapers down to 16" (41 cm).
- One-way "winged" state plow designed to throw snow higher.
- Rubber Flap (715007299) designed to keep snow away from the driver is offered as accessory (sold separately).
- Can-Am branded.

Can-Am ProMount 72" (183 cm) Steel Oneway State Blade	Fits ProMount Push Frame	715009879	\$705.99
---	--------------------------	-----------	----------



- Make the job easier with the right tools, clear long alleys and make the task easier by sending the snow further out of the way.
- Wing end of plow measures 26" (67 cm) high and tapers down to 16" (41 cm).
- One-way "winged" state plow designed to throw snow higher.
- Rubber flap (715007299) designed to keep snow away from the driver is offered as accessory (sold separately).
- Can-Am branded.

## CAN-AM ProMount PLOW ACCESSORIES

### NEW Can-Am ProMount Push Frame with Quick-Attach System

G2, G2 MAX

715008888

\$855.99



- New platform offering a plow ready vehicle frame with an integrated lead-in designed to receive the plow push frame hooks—no mounting plate needed!
- Adjustable roller and gas strut to support the front hooks at the appropriate height for your vehicle—no need to lift the plow push frame to hook it.
- Precise location of the rear hooks allows to clip with confidence each time.
- Attaches directly to the vehicle for quick installation—no mounting plate needed!
- Heavy-duty steel tubes designed to withstand the roughest use.
- Mount location provides ultimate push strength and traction.
- Designed for maximum plow lift height.
- Features a self-aligning quick-attach system, an easy foot-release pedal and an ergonomic handle for plow angle adjustment.
- Allows blade to swivel left or right, five positions.
- Compatible with all Can-Am ProMount blades.
- Plow Limit Switch recommended to extend winch cable lifespan.
- Plow Roller Fairlead included.
- Requires winch.

### Can-Am ProMount Edge Markers

Fits ProMount Plow Blades

715004206

\$48.99



- Help locate the edges of your plow.
- Height: 24" (60 cm).
- Sold in pairs.
- Compatible with Can-Am ProMount Steel and Flex2 blades with or without Blade Extensions (except for the Can-Am ProMount Steel 54" (137 cm) Blades).

### Can-Am ProMount 66" (168 cm) Plastic Wear Blade

Fits ProMount Plow Blades

715004482

\$192.49

### Can-Am ProMount 72" (183 cm) Plastic Wear Blade

Fits ProMount Plow Blades

715004483

\$213.99



- To help prevent scratches on smooth driveways and markable surfaces.

### Can-Am ProMount Drift Cutters

Fits ProMount Plow Blades

715006258

\$170.99



- Help keep snow in the plow.
- Dimensions: 17" x 13" (43.2 cm x 33 cm).
- Sold in pairs.
- Compatible with Can-Am ProMount Steel and Flex2 blades with or without Blade Extensions (except for the Can-Am ProMount Steel 54" (137 cm) Blades).

### Back Drag Blade

(Not illustrated)

Fits ProMount Plows (60" and more)

715007794

\$299.49

- ¼ thick steel swivel scraper.
- Lifts up when the vehicle is moving forward so as not to affect the scraping.
- Increased capacity to pull snow.
- More aggressive scraping in reverse mode.
- Lifts the scraper off the ground so that it scrapes evenly.
- Adjustable in length for compatibility with 60", 66" and 72" blades.
- Compatible with ProMount blades (Flex and Steel).

### Can-Am ProMount Push Frame with Quick-Attach System

G1, G1 MAX

715008116

\$598.99



- Heavy-duty steel tubes designed to withstand the roughest use.
- Mid-mount carriage provides ultimate push strength and traction.
- Designed for maximum plow lift height.
- Features a self-aligning quick-attach system, an easy foot release pedal and an ergonomic handle for plow angle adjustment.
- Plow Limit Switch recommended to extend winch cable lifespan.
- Can-Am ProMount Mounting Plate required for installation.
- Blade swivels left or right, 5 positions.
- Large pin designed for easy blade rotation to eliminate dirt and snow buildup at pivot point.

### NEW Can-Am ProMount Push Frame Extension

G2, G2 MAX

715009461

\$256.79



- Improved angle for a better ground contact.
- 13.5" (35 cm) push frame extension required when plow is installed with Apache Track systems.
- Compatible with the Can-Am ProMount Push Frame with Quick-Attach System (715008888).

<b>Can-Am ProMount Push Frame Extension</b>	G1, G1 MAX	<b>715006257</b>	<b>\$186.99</b>
---	------------	------------------	-----------------



- 12" (30 cm) push frame extension required when plow is installed with Apache Track Systems.
- Compatible with the Can-Am ProMount Push Frame with Quick-Attach System (715008116).

<b>Can-Am ProMount Mounting Plate</b>	G1, G1 MAX (2021 & prior)	<b>715007743</b>	<b>\$176.49</b>
---------------------------------------	---------------------------	------------------	-----------------



- Required to install the Can-Am ProMount Push Frame with Quick-Attach System.
- Mounting plate precision-designed to stay on year round without compromising ground clearance.
- Not compatible with S3 Front High Clearance A-Arm (715003784).

<b>Can-Am ProMount Mounting Plate</b>	G1, G1 MAX (2022 & up)	<b>715007745</b>	<b>\$181.99</b>
---------------------------------------	------------------------	------------------	-----------------



- Required to install the Can-Am ProMount Push Frame with Quick-Attach System.
- Mounting plate precision-designed to stay on year round without compromising ground clearance.
- Comes with the Plow Roller Fairlead.
- Not compatible with S3 Front High Clearance A-Arm (715003784).

<b>NEW Can-Am ProMount Plow Angling System</b>	G2, G2 MAX	<b>715009133</b>	<b>\$1,182.49</b>
--	------------	------------------	-------------------



- Improved operation speed for quicker plow angle adjustments.
- Converts your plow system into an easy-to-control accessory from the driver's seat.
- Allows you to have full up/down and left/right plow control at your fingertips with the supplied joystick.
- Using one hand to control all plow motions allows you to easily concentrate and manage your plowing tasks with ease.
- Compatible with the SSV ProMount Push Frame (715008888 or 715008116) and Blades.
- Not compatible with Apache Backcountry LT Track System.
- Winch and plow system sold separately.

<b>Can-Am ProMount Plow Angling System</b>	G1, G1 MAX	<b>715009241</b>	<b>\$1,182.49</b>
--	------------	------------------	-------------------



- Converts your plow system into an easy-to-control unit from the driver's seat.
- Allows you to have full up/down and left/right plow control at your fingertips with the supplied joystick.
- Using one hand to control all plow motions allows you to easily concentrate and manage your plowing tasks.
- Compatible with the SxS ProMount Push Frame and Blade.
- Not compatible with Apache Backcountry LT Track System.
- Push Frame Extension (715006257) is required for installation with the Front Rancher Bumper.
- Winch and plow sold separately.

<b>NEW Plow Quick Adjust Blade Shoes</b>	ProMount Steel & Flex2 Blades 60" (all years), 66" & 72" (2025 & prior)	<b>715009751</b>	<b>\$106.99</b>
--	---	------------------	-----------------



- Zinc-plated steel construction for corrosion resistance.
- Easy and quick tool-free adjustment.
- Pre-set adjustment for different heights.
- Larger shoe diameter for greater ground contact.
- Improved shoe design for better flotation.

<b>ProMount Plow Limit Switch</b> <i>(Not illustrated)</i>	G1, G1 MAX	<b>715006259</b>	<b>\$144.49</b>
---	------------	------------------	-----------------



- For controlling the cable tension when over-raising your plow system.
- Prevents winch, plow push frame and vehicle damage.
- Sensor relocated for optimal lift height.

<b>Plow Roller Fairlead</b>	G1, G1 MAX, G2, G2 MAX	<b>715001223</b>	<b>\$87.49</b>
-----------------------------	------------------------	------------------	----------------



- Cylindrical roller fairlead.
- Larger diameter lower roller reduces wear on wire rope for plow application.
- Can be used with all ProMount plows.

## SUPER-DUTY PLOW SYSTEM

<b>Super-Duty 72" (183 cm) Blade Plow Kits</b>	G1, G1 MAX	<b>715003416</b>	<b>\$2,059.97</b>
	<ul style="list-style-type: none"> <li>• A comprehensive plow system with manual lift and angling.</li> <li>• Ultra-durable 72" (183 cm) blade made of 12-gauge steel with integrated reinforcement and heavy-duty push tubes to tackle the most demanding jobs.</li> <li>• Requires a winch for raising and lowering.</li> <li>• Convenient disconnect system for quick and easy installation or removal.</li> <li>• Front mount provides minimum 11" (28 cm) lift distance.</li> <li>• Not compatible with Apache XC LT Tracks.</li> </ul> <p>This kit includes:</p> <ul style="list-style-type: none"> <li>- 72" (183 cm) Super-Duty Plow.</li> <li>- Super-Duty Plow Push Frame.</li> <li>- Super-Duty Plow Mounting Kit.</li> </ul>		
<b>Super-Duty Plow Hydraulic Angling Kit</b>	G1, G1 MAX (2019 & prior)	<b>715002840</b>	<b>\$1,668.99</b>
	G1, G1 MAX (2020 & up)	<b>715006038</b>	<b>\$1,676.99</b>
<ul style="list-style-type: none"> <li>• Allows you to have full up/down and left/right plow control at your fingertips.</li> <li>• Pre-assembled, it comes with everything you need to turn your Super-Duty Plow into a quick, easy-to-control unit from the driver's seat.</li> <li>• Using one hand to control all plow motions with the supplied joystick will allow you to easily concentrate and manage your plowing tasks.</li> <li>• With this commercial grade kit, you will reliably send snow exactly where you want all winter long.</li> <li>• Winch and plow sold separately.</li> </ul>			
<b>Super-Duty Plow Push Frame Extension</b>	Super-Duty Plow	<b>715001221</b>	<b>\$384.99</b>
<i>(Not illustrated)</i>	<ul style="list-style-type: none"> <li>• Extension to use the Super-Duty Plow with the Apache 360 LT Track System.</li> <li>• Comes with Plow Magnetic Switch and Plow Pulley.</li> <li>• Requires Front Bumper or Front Accessory Bar for installation.</li> <li>• Not compatible with Apache XC LT Tracks.</li> </ul>		
<b>Plow Blade Extensions</b>	Super-Duty Plow	<b>715001217</b>	<b>\$352.99</b>
	<ul style="list-style-type: none"> <li>• Side extensions for widening your plow blade by 6" (15 cm) on each side.</li> <li>• Include rubber flaps for extension parts.</li> <li>• Sold in pairs.</li> </ul>		
<b>Plow Edge Markers</b>	Super-Duty Plow	<b>715001216</b>	<b>\$50.49</b>
<i>(Not illustrated)</i>	<ul style="list-style-type: none"> <li>• For a more accurate view of the width of your plow.</li> <li>• Allows you to work closely around objects.</li> </ul>		
<b>Plow Drift Cutter</b>	Super-Duty Plow	<b>715001218</b>	<b>\$122.99</b>
<i>(Not illustrated)</i>	<ul style="list-style-type: none"> <li>• Keeps snow securely in the plow.</li> <li>• Allows you to cut a cleaner pass.</li> <li>• Sold individually.</li> </ul>		
<b>Plow Limit Switch</b>	G1, G1 MAX	<b>715006259</b>	<b>\$144.49</b>
	G2, G2 MAX	<b>715009894 NEW</b>	<b>\$160.49</b>
	<ul style="list-style-type: none"> <li>• For controlling the cable tension when over-raising your plow system.</li> <li>• Prevents winch, plow push frame and vehicle damage.</li> </ul>		
<b>Plow Rubber Flap</b>	Super-Duty Plow	<b>715001219</b>	<b>\$122.99</b>
<i>(Not illustrated)</i>	<ul style="list-style-type: none"> <li>• Keeps snow away from the driver and helps snow to roll in front of the plow.</li> </ul>		
<b>Plow Pulley</b>	Super-Duty Plow	<b>715002042</b>	<b>\$58.99</b>
<i>(Not illustrated)</i>	<ul style="list-style-type: none"> <li>• For use with the Super-Duty Plow.</li> <li>• Helps winching efficiency.</li> <li>• Requires Front XT Bumper.</li> </ul>		

## Plow Magnetic Switch

(Not illustrated)

Super-Duty Plow

715001995

\$138.99

- Magnetic switch that stops the winch to prevent cable, winch and frame damage.
- For use with Super-Duty Plow.

# COVERS & ADD-ONS

Trailer Cover	G1	715004453	\$340.49
	G1 MAX	715004454	\$542.99



- Heavy-duty canvas made of UV-resistant solution-dyed polyester.
- Inner soft liner protects windshield and colored panels from abrasion.
- All high-abrasion areas are reinforced with a double canvas layer.
- Weather-resistant trailering cover protects your vehicle during storage and transportation.
- Opening for fuel cap.
- Quick and easy installation.
- Designed to perfectly fit your vehicle with or without Can-Am accessories.
- Does not fit with Adventure Roof Rack (715003870).

Bolt-On <sup>†</sup> Retractable Ratcheting Tie-Downs	295101072	\$38.49
---	-----------	---------



- Perfect for transporting your powersport vehicle or securing loads.
- Mount easily: Bolt on any flat surface (e.g., truck bed or frame).
- 1" x 6' (2.5 cm x 1.8 m) tie-down strap with heavy-duty stitching that delivers a 500 lb (226 kg) working load strength and 1,500 lb (680 kg) break strength.
- Convenient retractable push button automatically slackens, spools and stores away strap, while the ratchet mechanism tightens the strap snugly to secure your vehicle or load into place.
- Rubber ratcheting handle provides firm grip, and the hook is vinyl coated to protect whatever surface it hooks into.
- Sold in pairs.

Ratchet Tie-Downs	715008309 - Black/Gray	\$31.99
-------------------	------------------------	---------



- 400 lb (181 kg) safe working load.
- 1" x 10' (2.5 cm x 3 m) strap with Sea-Doo, Ski-Doo and Can-Am logos.
- Deluxe ratchet with rubber handle.
- Coated S hooks.
- Pack of 2.

Heavy-Duty Ratchet Tie-Down	715008308	\$47.99
-----------------------------	-----------	---------



- 1,000 lb (454 kg) safe working load.
- 1.5" x 6' (38 mm x 1.8 m) strap with BRP brands.
- Deluxe ratchet with rubber handle.
- Black-coated clip hooks.
- 12" (300 mm) webbing included.
- Pack of two.

# CAN-AM MAVERICK R



# CAN-AM MAVERICK R

CAN-AM MAVERICK R



## **COMPARATIVE CHART** 82

## **ACCESSORIES** 85



Roofs	85
Windshields & Wind Protection	85
Mirrors	87
Doors	87
HMWPE Skid Plates	88
Bumpers & Protection	89
LinQ: Easy On, Easy Off Cargo	91
Racks & Storage	96
ACM & SMART Accessories	99
Lights	102
Audio Systems	107
Electrical & Electronic Accessories	108
Winches	109
Performance	110





				
	MAVERICK R X***	MAVERICK R X RS***	MAVERICK R X RC***	
<b>COLOR OPTIONS</b>	Legion Red	Triple Black Dusty Navy	Loft Green Satin	
<b>ENGINES</b>	<b>Type</b>	999T DCT  240 hp, Rotax® 999T engine, 999 cc turbocharged triple-cylinder engine, liquid-cooled with integrated intercooler and high-performance air filter	999T DCT  240 hp, Rotax® 999T engine, 999 cc turbocharged triple-cylinder engine, liquid-cooled with integrated intercooler and high-performance air filter	999T DCT  240 hp, Rotax® 999T engine, 999cc turbocharged triple-cylinder engine, liquid-cooled with integrated intercooler and high-performance air filter and launch control
	<b>Fuel Delivery System</b>	Intelligent Throttle Control (iTC™) with Electronic Fuel Injection (EFI)	Intelligent Throttle Control (iTC™) with Electronic Fuel Injection (EFI)	Intelligent Throttle Control (iTC™) with Electronic Fuel Injection (EFI)
	<b>Transmission</b>	Rotax® DCT, 7-speed with High & Low range	Rotax® DCT, 7-speed with High & Low range	Rotax® DCT, 7-speed with High & Extra Low range
	<b>Drive Train</b>	Lockable front differential with exclusive Smart-Lok™ True 2WD / 4WD with front diff. lock / 4WD TRAIL ACTIV / 4WD TRAIL	Lockable front differential with exclusive Smart-Lok™ True 2WD / 4WD with front diff. lock / 4WD TRAIL ACTIV / 4WD TRAIL	Lockable front differential with exclusive Smart-Lok™ True 2WD / 4WD with front diff. lock / 4WD TRAIL ACTIV / 4WD TRAIL / 4WD ROCK
	<b>Power Steering</b>	High torque Gen 2 Tri-Mode DPS™	High torque Gen 2 Tri-Mode DPS™	High torque Gen 2 Tri-Mode DPS™
	<b>SUSPENSIONS</b>	<b>Front Suspension</b>	Forged aluminum heavy-duty tall knuckle Double A-arm with sway bar / 25 in. (63.5 cm) suspension travel	Forged aluminum heavy-duty tall knuckle Double A-arm with sway bar / 25 in. (63.5 cm) suspension travel
<b>Front Shocks</b>		FOX® 2.5 PODIUM Piggyback with QS3® compression adjustment	FOX® 2.5 PODIUM RC2¹ Piggyback with bypass, dual speed compression and rebound adjustments OR FOX® 2.5 PODIUM¹ Piggyback with bypass and Smart-Shox technology featuring Live Valve Gen 3 (Dual Valve compression & rebound)	FOX® 2.5 PODIUM RC2¹ Piggyback with bypass, dual speed compression and rebound adjustments OR FOX® 2.5 PODIUM¹ Piggyback with bypass and Smart-Shox technology featuring Live Valve Gen 3 (Dual Valve compression & rebound)
<b>Rear Suspension</b>		4-link trailing arm with forged aluminum heavy-duty tall knuckle / 25 in. (63.5 cm) suspension travel	4-link trailing arm with forged aluminum heavy-duty tall knuckle / 25.5 in. (64.8 cm) suspension travel	4-link trailing arm with forged aluminum heavy-duty tall knuckle / 26 in. (66 cm) suspension travel
<b>Rear Shocks</b>		FOX® 2.5 PODIUM Piggyback with QS3® compression adjustment and bottom-out control	FOX® 3.0 PODIUM RC2¹ Piggyback with bypass, dual speed compression and rebound adjustments OR FOX® 3.0 PODIUM¹ Piggyback with bypass and Smart-Shox technology featuring Live Valve Gen 3 (Dual Valve compression & rebound)	FOX® 3.0 PODIUM RC2¹ Piggyback with bypass, dual speed compression and rebound adjustments OR FOX® 3.0 PODIUM¹ Piggyback with bypass and Smart-Shox technology featuring Live Valve Gen 3 (Dual Valve compression & rebound)
<b>TIRES/WHEELS</b>	<b>Front/Rear Tires</b> ITP XNR Tenacity 32 x 10 x 16 in. 16 in. aluminum flow formed	ITP XNR Tenacity 32 x 10 x 16 in. 16 in. aluminum flow formed beadlock	XPS Hammer King 35 x 10 x 16 in. 16 in. aluminum flow formed beadlock	
<b>BRAKES</b>	<b>Front</b>	32 mm hydraulic triple-piston calipers with a 265 mm disc	32 mm hydraulic triple-piston calipers with a 265 mm disc	32 mm hydraulic triple-piston calipers with a 265 mm disc
	<b>Rear</b>	30 mm hydraulic twin-piston calipers with a 255 mm disc	30 mm hydraulic twin-piston calipers with a 255 mm disc	32 mm hydraulic twin-piston calipers with a 255 mm disc
<b>DIMENSIONS / CAPACITIES</b>	<b>Estimated Dry Weight</b>	2,254 lb (1,024 kg)	2,274 lb (1,031 kg) 2,284 lb (1,035 kg) with Smart-Shox	2,462 lb (1,119 kg) 2,472 lb (1,123 kg) with Smart-Shox
	<b>Chassis / Cage</b>	High strength (dual phase) steel tubing and stampings	High strength (dual phase) steel tubing and stampings	High strength (dual phase) steel tubing and stampings
	<b>L x W x H</b>	138.7 x 78.1 x 70.4 in. (352.2 x 198.5 x 177.8 cm)	140 x 78.1 x 71.5 in. (355.6 x 198.5 x 181.5 cm)	147.4 x 78.1 x 72.6 in. (374.3 x 198.4 x 184.5 cm)
	<b>Wheelbase</b>	108 in. (274.3 cm)	108 in. (274.3 cm)	110 in. (279.1 cm)
	<b>Ground Clearance</b>	17 in. (43.2 cm)	17 in. (43.2 cm)	18 in. (45.7 cm)
	<b>Rack Capacity</b>	200 lb (90 kg)	200 lb (90 kg)	200 lb (90 kg)
	<b>Fuel Capacity</b>	Total: 2.1 gal (8.1 L) 13.2 gal (50 L)	Total: 2.1 gal (8.1 L) 13.2 gal (50 L)	Total: 2.1 gal (8.1 L) 13.2 gal (50 L)
<b>FEATURES</b>	<b>Gauge</b>	4.5 in. wide digital display with keypad & 10.25 in. touchscreen display	4.5 in. wide digital display with keypad & 10.25 in. touchscreen display	4.5 in. wide digital display with keypad & 10.25 in. touchscreen display
	<b>Instrumentation</b>	USB-A (2 charging ports & 1 communication port) DC outlet (10 A)	USB-A (2 charging ports & 1 communication port) DC outlet (10 A)	USB-A (charging port & communication port) DC outlet (10 A)
	<b>Anti-theft System</b>	RF Digitally Encoded Security System (D.E.S.S.™) with Start/Stop button	RF Digitally Encoded Security System (D.E.S.S.™) with Start/Stop button	RF Digitally Encoded Security System (D.E.S.S.™) with Start/Stop button
	<b>Lighting</b>	Premium high-performance LED headlights Can-Am LED signature	Premium high-performance LED headlights Can-Am LED signature	Premium high-performance LED headlights Can-Am LED signature with start-up animation
	<b>Winch</b>	Winch-ready bumper (4,500 lb / 2,041 kg winch not installed)	Winch-ready bumper (4,500 lb / 2,041 kg winch not installed)	4,500 lb (2,041 kg) winch with synthetic cable and roller fairlead
	<b>Magneto</b>	1,700 W	1,700 W	1,700 W
	<b>Protection</b>	Full hard roof Premium half doors Front lower deflector Front / rear anchor Full plastic skid plate	Full hard roof Premium half doors Front lower deflector Front / rear anchor Full plastic skid plate	Full hard roof Premium half doors Front lower deflector Front / rear anchor Full HD HMW plastic skid plate Front bumper Front intrusion bar Rock slider (UHMWPE) Rock guard

\*Smart-Lok was developed in conjunction with TEAM Industries, a market leader in the drive train industry.  
\*\*Smart-Shox was developed in conjunction with Tractive Industries, a market leader in the suspension industry.  
\*\*\*1-year BRP limited warranty. B.E.S.T. term available up to 30 months.

				
	<b>MAVERICK R MAX X***</b>	<b>MAVERICK R MAX X RS***</b>	<b>MAVERICK R MAX X RC***</b>	
<b>COLOR OPTIONS</b>	Legion Red	Triple Black Dusty Navy	Loft Green Satin	
<b>ENGINES</b>	<b>Type</b>	999T DCT  240 hp, Rotax® 999T engine, 999 cc turbocharged triple-cylinder engine, liquid-cooled with integrated intercooler and high-performance air filter	999T DCT  240 hp, Rotax® 999T engine, 999 cc turbocharged triple-cylinder engine, liquid-cooled with integrated intercooler and high-performance air filter	999T DCT  240 hp, Rotax® 999T engine, 999 cc turbocharged triple-cylinder engine, liquid-cooled with integrated intercooler and high-performance air filter and launch control
	<b>Fuel Delivery System</b>	Intelligent Throttle Control (ITC™) with Electronic Fuel Injection (EFI)	Intelligent Throttle Control (ITC™) with Electronic Fuel Injection (EFI)	Intelligent Throttle Control (ITC™) with Electronic Fuel Injection (EFI)
	<b>Transmission</b>	Rotax® DCT, 7-speed with High & Extra Low range	Rotax® DCT, 7-speed with High & Extra Low range	Rotax® DCT, 7-speed with High & Extra Low range
	<b>Drive Train</b>	Lockable front differential with exclusive Smart-Lok™ True 2WD / 4WD with front diff. lock / 4WD TRAIL ACTIV / 4WD TRAIL	Lockable front differential with exclusive Smart-Lok™ True 2WD / 4WD with front diff. lock / 4WD TRAIL ACTIV / 4WD TRAIL	Lockable front differential with exclusive Smart-Lok™ True 2WD / 4WD with front diff. lock / 4WD TRAIL ACTIV / 4WD TRAIL / 4WD ROCK
	<b>Power Steering</b>	High torque Gen 2 Tri-Mode DPS™	High torque Gen 2 Tri-Mode DPS™	High torque Gen 2 Tri-Mode DPS™
	<b>Front Suspension</b>	Forged aluminum heavy-duty tall knuckle Double A-arm with sway bar / 24 in. (61 cm) suspension travel	Forged aluminum heavy-duty tall knuckle Double A-arm with sway bar / 24 in. (61 cm) suspension travel	Forged aluminum heavy-duty tall knuckle Double A-arm with sway bar / 25 in. (63.5 cm) suspension travel
<b>SUSPENSIONS</b>	<b>Front Shocks</b>	FOX® 2.5 PODIUM Piggyback with QS3® compression adjustment	FOX® 2.5 PODIUM RC2¹ Piggyback with bypass, dual speed compression and rebound adjustments OR FOX® 2.5 PODIUM¹ Piggyback with bypass and Smart-Shox technology featuring Live Valve Gen 3 (Dual Valve compression & rebound)	FOX® 2.5 PODIUM RC2¹ Piggyback with bypass, dual speed compression and rebound adjustments OR FOX® 2.5 PODIUM¹ Piggyback with bypass and Smart-Shox technology featuring Live Valve Gen 3 (Dual Valve compression & rebound)
	<b>Rear Suspension</b>	4-link trailing arm with forged aluminum heavy-duty tall knuckle / 24 in. (61 cm) suspension travel	4-link trailing arm with forged aluminum heavy-duty tall knuckle / 24 in. (61 cm) suspension travel	4-link trailing arm with forged aluminum heavy-duty tall knuckle / 25 in. (63.5 cm) suspension travel
	<b>Rear Shocks</b>	FOX® 2.5 PODIUM Piggyback with QS3® compression adjustment and bottom-out control	FOX® 3.0 PODIUM RC2¹ Piggyback with bypass, dual speed compression and rebound adjustments OR FOX® 3.0 PODIUM¹ Piggyback with bypass and Smart-Shox Technology featuring Live Valve Gen 3 (Dual Valve compression & rebound)	FOX® 3.0 PODIUM RC2¹ Piggyback with bypass, dual speed compression and rebound adjustments OR FOX® 3.0 PODIUM¹ Piggyback with bypass and Smart-Shox technology featuring Live Valve Gen 3 (Dual Valve compression & rebound)
<b>TIRES/ WHEELS</b>	<b>Front/Rear Tires</b> ITP XNR Tenacity 32 x 10 x 16 in. 16 in. aluminum flow formed	<b>Front/Rear Tires</b> ITP XNR Tenacity 32 x 10 x 16 in. 16 in. aluminum flow formed beadlock	<b>Front/Rear Tires</b> XPS Hammer King 35 x 10 x 16 in. 16 in. aluminum flow formed beadlock	
<b>BRAKES</b>	<b>Front</b>	32 mm hydraulic triple-piston calipers with a 265 mm disc	32 mm hydraulic triple-piston calipers with a 265 mm disc	32 mm hydraulic triple-piston calipers with a 265 mm disc
	<b>Rear</b>	32 mm hydraulic twin-piston calipers with a 255 mm disc	32 mm hydraulic twin-piston calipers with a 255 mm disc	30 mm hydraulic twin-piston calipers with a 255 mm disc
<b>DIMENSIONS / CAPACITIES</b>	<b>Estimated Dry Weight</b>	2,648 lb (1,204 kg)	2,658 lb (1,209 kg) 2,668 lb (1,214 kg) with Smart-Shox	2,818 lb (1,281 kg) 2,828 lb (1,285 kg) with Smart-Shox
	<b>Chassis / Cage</b>	High strength (dual phase) steel tubing and stampings	High strength (dual phase) steel tubing and stampings	High strength (dual phase) steel tubing and stampings
	<b>L x W x H</b>	175 x 78.1 x 69.2 in. (444.7 x 198.4 x 175.7 cm)	175 x 78.1 x 69.2 in. (444.7 x 198.4 x 175.7 cm)	180 x 78.1 x 72.6 in. (457.1 x 198.4 x 184.5 cm)
	<b>Wheelbase</b>	142.5 in. (365 cm)	142.5 in. (365 cm)	142.5 in. (365 cm)
	<b>Ground Clearance</b>	17 in. (43.2 cm)	17 in. (43.2 cm)	18 in. (45.7 cm)
	<b>Rack Capacity</b>	200 lb (90 kg)	200 lb (90 kg)	200 lb (90 kg)
	<b>Storage Capacity</b>	Total: 2.1 gal (8.1 L)	Total: 2.1 gal (8.1 L)	Total: 2.1 gal (8.1 L)
	<b>Fuel Capacity</b>	13.2 gal (50 L)	13.2 gal (50 L)	13.2 gal (50 L)
<b>FEATURES</b>	<b>Gauge</b>	4.5 in. wide digital display with keypad & 10.25 in. touchscreen display	4.5 in. wide digital display with keypad & 10.25 in. touchscreen display	4.5 in. wide digital display with keypad & 10.25 in. touchscreen display
	<b>Instrumentation</b>	USB-A (2 charging ports & 1 communication port) DC outlet (10 A)	USB-A (2 charging ports & 1 communication port) DC outlet (10 A)	USB-A (charging port & communication port) DC outlet (10 A)
	<b>Anti-theft System</b>	RF Digitally Encoded Security System (D.E.S.S.™) with Start/Stop button	RF Digitally Encoded Security System (D.E.S.S.™) with Start/Stop button	RF Digitally Encoded Security System (D.E.S.S.™) with Start/Stop button
	<b>Lighting</b>	Premium high-performance LED headlights Can-Am LED signature	Premium high-performance LED headlights Can-Am LED signature	Premium high-performance LED headlights Can-Am LED signature with start-up animation
	<b>Winch</b>	Winch-ready bumper (4,500 lb / 2,041 kg winch not installed)	Winch-ready bumper (4,500 lb / 2,041 kg winch not installed)	4,500 lb (2,041 kg) winch with synthetic cable and roller fairlead
	<b>Magneto</b>	1,700 W	1,700 W	1,700 W
	<b>Protection</b>	Full hard roof Premium half doors Front lower deflector Front / rear anchor 3/8" full HD HMW plastic skid plate Rock guard	Full hard roof Premium half doors Front lower deflector Front / rear anchor 3/8" full HD HMW plastic skid plate Rock guard	Full hard roof Premium half doors Front lower deflector Front / rear anchor Full HD HMW plastic skid plate Front bumper Front intrusion bar Rock slider (UHMWPE) Rock guard

\*Smart-Lok was developed in conjunction with TEAM Industries, a market leader in the drive train industry.  
\*\*Smart-Shox was developed in conjunction with Tractive Industries, a market leader in the suspension industry.  
\*\*\*1-year BRP limited warranty. B.E.S.T. term available up to 30 months.



# ROOFS

<b>Sport Roof</b>	Maverick R	<b>715007364</b>	<b>\$519.99</b>
	Maverick R MAX	<b>715008074</b>	<b>\$889.99</b>

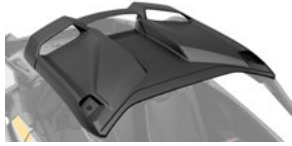

- Impact-resistant injected polypropylene.
- Provides excellent protection from the elements and downhill visibility.
- Designed to work with the Cold Air Roof Scoop.
- Windshield compatible.

<b>Cold Air Roof Scoop</b>	Maverick R	<b>715008280</b>	<b>\$534.99</b>
	Maverick R MAX	<b>715008301</b>	<b>\$748.99</b>



- Feeds fresh air to the engine compartment.
- Sleek design for a sleek racing look.
- Increases cold air to the intake to prevent power loss.
- Required when using a full windshield.
- Requires a Sport Roof or Can-Am JL Audio Roof – Level 4.
- Not compatible with the Audio Roof Flip Kit.

# WINDSHIELDS & WIND PROTECTION

## WINDSHIELDS

<b>Powerflip Windshield</b>	Maverick R, Maverick R MAX	<b>715009900</b>	<b>\$1,799.99</b>
-----------------------------	----------------------------	------------------	-------------------



- The PowerFlip Windshield is equipped with electric cylinders that allow the rider to adjust the windshield opening at the touch of a button.
- High-impact-resistant Quantum<sup>1</sup> hardcoated polycarbonate full windshield with a rubber seal contour and a tinted top section.
- Allows you to quickly adapt to changing conditions by adjusting the windshield as you go.
- Can be fully opened for optimal visibility and ventilation, fully closed for maximum protection from the elements, or somewhere in between.
- You have an infinite number of opening possibilities depending on your protection, visibility and airflow preferences.
- Requires a Cold Air Roof Scoop (715008280 or 715008301).
- Needs Accessory Control Module (ACM) (715010097) or Powerflip Windshield Harness (715008854) for installation.
- Not compatible with SMART Integrated LED Roof Light (715007322) and Audio Roof Flip Kit (715008164).

<b>Glass Windshield</b>	Maverick R, Maverick R MAX	<b>715010203</b>	<b>\$1,259.99</b>
-------------------------	----------------------------	------------------	-------------------



- Curved and laminated glass full windshield.
- Seals firmly against the cage and protects both the rider and the passenger from the elements.
- Provides maximum optical clarity and abrasion resistance.
- Must be used with the Wiper & Washer Kit for clear visibility during severe riding conditions, including mud riding.
- Use with rear wind protection to maximize passenger comfort.
- Must be used with the Cold Air Roof Scoop (715008280 or 715008301).
- Compatible with the SMART Integrated Roof LED Light.
- Not compatible with the Audio Roof Flip Kit (715008164).

<b>Full Windshield – Hardcoated</b>	Maverick R, Maverick R MAX	<b>715007321</b>	<b>\$899.99</b>
-------------------------------------	----------------------------	------------------	-----------------



- Highly impact-resistant Quantum<sup>1</sup> hardcoated polycarbonate full windshield.
- Formed polycarbonate construction for enhanced rigidity.
- Provides excellent optical clarity and better abrasion resistance.
- Protects the driver and the passenger from the elements.
- Quick and easy tool-less removal.
- Use with rear wind protection to maximize comfort for the passenger.
- Can be used with the Windshield Wiper & Washer Kit (715007173) (light-duty usage only).
- Compatible with SMART Integrated Roof LED Light.
- Must be used with the Cold Air Roof Scoop (715008280 or 715008301).
- Not compatible with the Audio Roof Flip Kit (715008164).

<b>SMART PowerFlip Intermittent Windshield Wiper &amp; Washer Kit</b>	Maverick R, Maverick R MAX	<b>715008555</b>	<b>\$748.99</b>
---	----------------------------	------------------	-----------------



- Washer fluid dispenser is perfectly concealed on the vehicle.
- Must be installed with the PowerFlip Windshield (715009900) (sold separately).
- SMART and fixed intermittence wiper speed feature available when the kit is installed in combination with ACM.
- Electric harness required (715008855) to hook up and operate the SMART PowerFlip Intermittent Windshield Wiper & Washer Kit in ON/OFF functionality when the ACM is not installed (sold separately).

<b>Powerflip Windshield Harness</b>	Maverick R, Maverick R MAX	<b>715008854</b>	<b>\$139.49</b>
-------------------------------------	----------------------------	------------------	-----------------



- Electric harness required to hook up and operate the Powerflip Windshield (715009900) for on/off function when ACM is not installed.

<b>SMART Intermittent Wiper &amp; Washer Kit</b>	Maverick R, Maverick R MAX	<b>715007173</b>	<b>\$745.49</b>
--	----------------------------	------------------	-----------------



- An ideal way to keep your windshield clear in the rain, or while riding through mud and water.
- The wiper mechanism and washer fluid dispenser are perfectly concealed on the vehicle.
- The wiper and washer fluid dispenser installs at the bottom of the windshield for maximum visibility.
- For use on glass or hardcoated windshields.
- SMART and fixed intermittence wiper speed feature available when the kit is installed in combination with ACM.
- Electric harness required (715008855) to hook up and operate the SMART Intermittent Windshield Wiper & Washer Kit in ON/OFF functionality when the ACM is not installed (sold separately).

<b>Wiper &amp; Washer Kit Wiring Harness</b>	Maverick R, Maverick R MAX	<b>715008855</b>	<b>\$107.49</b>
--	----------------------------	------------------	-----------------



- Electric harness required to hook up and operate in ON/OFF functionality the SMART PowerFlip Intermittent Windshield Wiper & Washer Kit and the SMART Intermittent Windshield Wiper & Washer Kit.

<b>Manual Wiper Kit</b>	Maverick R, Maverick R MAX	<b>715009424</b>	<b>\$127.99</b>
-------------------------	----------------------------	------------------	-----------------



- Single manual wiper that can be used to clear windshield of debris.
- Easy to install system that requires no electrical hookup.
- Large ergonomic handle provides a good grip over the entire sweeping surface.
- Compatible with glass and hardcoated windshields that use top mounted wipers.

## REAR WIND PROTECTION

<b>Rear Polycarbonate Window</b>	Maverick R, Maverick R MAX	<b>715007315</b>	<b>\$457.99</b>
----------------------------------	----------------------------	------------------	-----------------



- High impact-resistant polycarbonate window.
- Reduces windshield backdraft and stops dust and rain from entering the cabin for added comfort.
- Quick and easy installation.
- Designed to work with Can-Am's JL Audio Level – 3 and 5 rear speakers, and all roofs.

<b>Rear Wind Screen for Speakers</b>	Maverick R, Maverick R MAX	<b>715009175</b>	<b>\$148.99</b>
--------------------------------------	----------------------------	------------------	-----------------



- Full rear mesh screen reduces windshield backdraft for added cabin comfort.
- Installs quickly and easily on roll cage.
- Holes allowing the clearance of audio surround speakers.

<b>Rear Wind Screen</b>	Maverick R, Maverick R MAX	<b>715007317</b>	<b>\$148.99</b>
-------------------------	----------------------------	------------------	-----------------

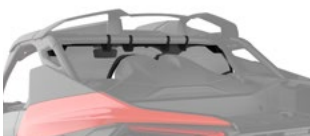

- Full rear mesh screen reduces windshield backdraft for added cabin comfort.
- Installs quickly and easily on roll cage.
- Not compatible with Can-Am JL Audio System – Level 3 (715007954) and Level 5 (715007957).

# MIRRORS

<b>Aluminum Side Mirrors</b>	Maverick R, Maverick R MAX	<b>715007363</b>	<b>\$351.49</b>
------------------------------	----------------------------	------------------	-----------------



- Sleek design.
- High-quality black molded aluminum for extreme durability.
- The convex surface provides a wider field of view and better visibility around the unit.
- Can be installed at any height on the cage A-pillar for optimized rider vision.
- Possibility to install the Integrated LED Side Mirror Lights (715007185).
- Adjustable ball-joint mirrors.
- Possibility to fold down the mirrors (fold-away mechanism).
- Compatible with windshields and upper door net.
- Sold in pairs.

<b>Side Mirrors</b>	Maverick R, Maverick R MAX	<b>715007188</b>	<b>\$212.99</b>
---------------------	----------------------------	------------------	-----------------



- Sleek design.
- High-impact resistant plastic mirrors.
- The convex surface provides a wider field of view and better visibility around the unit. Can be installed at any height on the cage A-pillar for optimized rider vision.
- Adjustable ball-joint mirrors.
- Possibility to fold down the mirrors (fold-away mechanism).
- Compatible with windshields and upper door net.
- Sold in pairs.

<b>Rear View Mirror and Camera Monitor</b>	Maverick R, Maverick R MAX	<b>715009410</b>	<b>\$534.99</b>
--	----------------------------	------------------	-----------------



- Fully waterproof rearview mirror and monitor kit.
- See exactly what you need to see with the multiple camera feeds from the rear view camera.
- This unit replaces the stock rearview mirror (the screen is integrated in the unit's replacement rearview mirror).
- The camera uses infrared light for night vision capabilities.

# DOORS

<b>NEW Soft Upper Door Panels</b>	Maverick R	<b>715007432</b> • 2 doors	<b>\$1,155.49</b>
	Maverick R MAX	<b>715007894</b> • 4 doors	<b>\$2,059.99</b>



- Weather-resistant panels reinforced with aluminum frame offer good protection from the elements.
- This extension is an excellent addition to the half-door, providing full coverage.
- Made of heavy-duty UV-resistant solution-dyed polyester canvas for excellent resistance to tear and abrasion.
- Zip-down windows made of clear vinyl for added ventilation with heavy duty zippers.
- Ensures high sealing edge performance.
- Easy to use, it follows the door's movements, facilitating ingress and egress.

<b>Upper Wind Nets</b>	Maverick R	<b>715007376</b>	<b>\$564.49</b>
	Maverick R MAX	<b>715007962</b> <b>NEW</b>	<b>\$1,069.99</b>



- Complete mesh screen net with a steel frame attaches to the doors of the vehicle for added protection from the wind and mud.
- Easy to use, it follows the door's movements, facilitating ingress and egress.
- Net zips up and down for added ventilation when required.
- The window can be rolled down and attached with a strap to hold it in position.

# HMWPE SKID PLATES

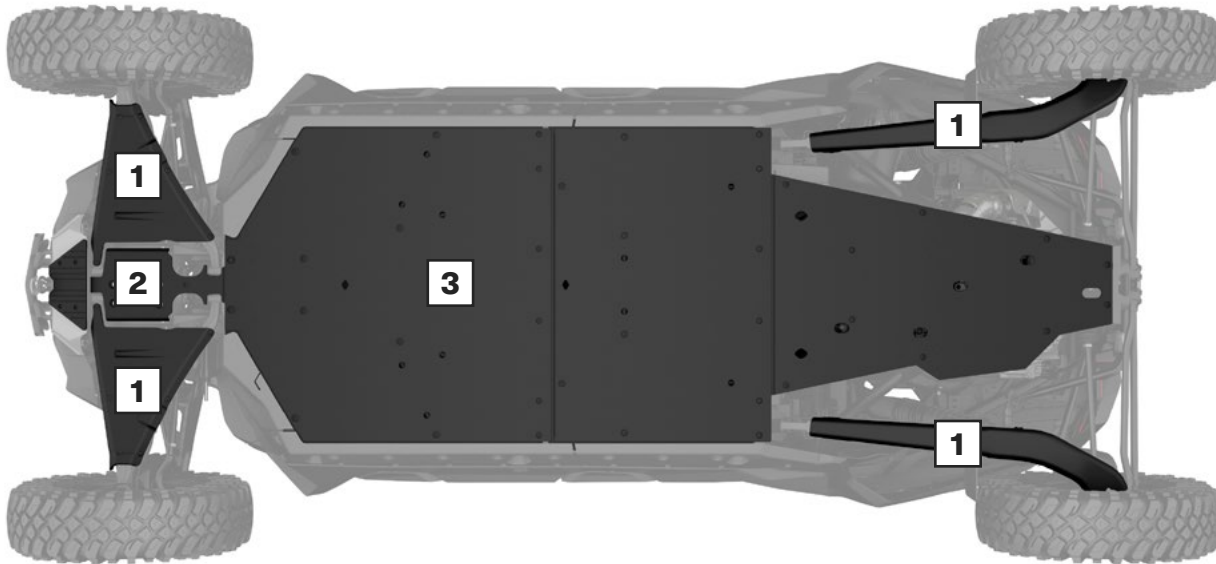

Our plastic plates glide smoothly and silently over obstacles, offering great protection in rough terrain. Made of abrasion-resistant thermoformed  $\frac{3}{8}$ " (10 mm) thick High Molecular Weight Polyethylene (HMWPE).

- Lighter than aluminum.
- Superior stress crack resistance.
- High-impact strength.

## MAVERICK R

## MAVERICK R MAX

### HMWPE SKID PLATE PROTECTION KIT

715007373

-

### INDIVIDUAL HMWPE SKID PLATES

<b>1</b>	HMWPE Front A-Arm and Trailing Arm Protectors	715007183	715007183
<b>2</b>	HMWPE Front Skid Plate	715007313	715007313
<b>3</b>	HMWPE Underbelly Plate	715007314	-
<b>4</b>	HMWPE Front (Nose) Skid Plate	715010009	715010009

# BUMPERS & PROTECTION

## BUMPERS

### NEW Front Bumper X rc

Maverick R, Maverick R MAX

■ 715010008 • Black

**\$372.74**



- Sleek and rugged design.
- Provides added protection without sacrificing the agility and performance of the vehicle.
- Made of heavy-duty steel tubing to protect the front of the unit.
- Inside and outside anti-corrosion coating with durable powder coat finish.
- Combine with the Rock Sliders and Rear Bumper for ultimate protection.
- Requires Front Bumper X rc Light Support (715010532) installation of lights.
- Winch compatible.

### Trail Front Bumpers

Maverick R, Maverick R MAX

■ 715010071 • Black  
 ■ 715010072 • Yellow  
 ■ 715009925 • Legion Red

**\$660.49**



- Can-Am's largest front bumper protects the headlights and radiator area of the unit.
- Added heavy-duty protection in extreme driving conditions.
- Made of 1.5" (3.8 cm) diameter steel tubing.
- Anti-corrosion coating with durable powder coat finish.
- Combine with the Rock Sliders and Rear Bumper for ultimate protection.
- Features integrated mounting points for lights.
- Winch compatible.

### Desert Front Bumpers

Maverick R, Maverick R MAX

■ 715007311 • Black  
 ■ 715007691 • Yellow  
 ■ 715009926 • Legion Red

**\$457.99**



- Sleek and rugged design.
- Provides added protection without sacrificing the agility and performance of the vehicle.
- Made of heavy-duty steel profiled tubing to protect the front of the unit.
- Inside and outside anti-corrosion coating with durable powder coat finish.
- Combine with the Rock Sliders and Rear Bumper for ultimate protection.
- Features integrated mounting points for lights.
- Winch compatible.

### Dune Front Bumpers

Maverick R, Maverick R MAX

■ 715007169 • Black  
 ■ 715007305 • Raw Metal

**\$468.49**



- Highly integrated bumper that creates a more pronounced attack angle and provides added protection to the vehicle.
- Allows for better ground clearance.
- The sleek design gives the unit a sportier look.
- Made of heavy-duty steel with a 1/8" (3 mm) aluminum plate.
- Inside and outside anti-corrosion coating with durable powder coat finish.
- Features an integrated Tow Hook.
- Not winch compatible.

### Desert Rear Bumpers

Maverick R, Maverick R MAX

■ 715007172 • Black  
 ■ 715007694 • Yellow  
 ■ 715009924 • Legion Red

**\$489.99**



- Rugged design.
- Provides added protection to the rear of the unit without sacrificing the agility and performance of the vehicle.
- Gives riders extra grip on the bumper and improves accessibility to rear cargo.
- Made of heavy-duty steel profiled tubing.
- Inside and outside anti-corrosion coating with durable powder coat finish.
- Combine with the Rock Sliders and Front Bumper for ultimate protection.

## ROCK SLIDERS

	Maverick R	<ul style="list-style-type: none"> <li>■ 715007170 • Black</li> <li>■ 715007693 • Yellow</li> <li>■ 715009923 • Legion Red</li> </ul>	<b>\$588.49</b>
<b>Rock Sliders</b>	Maverick R MAX	<ul style="list-style-type: none"> <li>■ 715007922 • Black</li> <li>■ 715007923 • Yellow</li> <li>■ 715009922 • Legion Red</li> </ul>	<b>\$962.99</b>

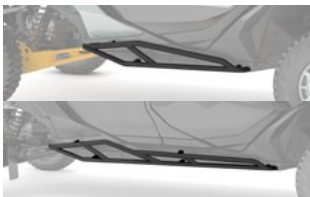

- Protect the vehicle's sides against obstacles.
- With added grip on top to improve accessibility of the roof cargo.
- Made of unique heavy-duty steel profiled tubing.
- Inside and outside anti-corrosion coating with durable powder coat finish.
- Combine with the Front and Rear Bumpers for ultimate protection.
- Sold in pairs.

## HMW-HDPE Rock Sliders

	Maverick R	<b>715008142</b>	<b>\$383.49</b>
--	------------	------------------	-----------------



- The sleek design gives the vehicle a sportier look.
- Tight integration with the unit's body to provide maximum obstacle clearance and outstanding protection.
- Made of combination of HMWPE and HDPE for extra durability.
- Add the Dune Front Bumper for ultimate protection and integrated lights for optimal visibility.
- Sold in pairs.

## INTRUSION BAR

### Front Intrusion Bar

	Maverick R, Maverick R MAX	■ 715007312 • Black	<b>\$478.99</b>
--	----------------------------	---------------------	-----------------



- The steel intrusion bar matches the vehicle's styling and enhances its visual impact.
- The tube's design doesn't obstruct the rider's line of sight and reduces blind spots for increased visibility.
- Inside and outside anti-corrosion coating with durable powder coat finish.
- Compatible with the 40" (102 cm) Baja Designs OnX6 Arc LED Light Bar (710006818) and SMART Integrated LED Roof Light (715007322).
- Compatible with all windshields.



# LINQ: EASY ON, EASY OFF CARGO



## MAVERICK R'S LINQ ACCESSORIES

### MOUNTING LOCATION AND REQUIREMENTS

<ul style="list-style-type: none"> <li>• No tools needed: Quickly install and remove accessories by hand</li> <li>• Equip your Can-Am for specialized tasks in no time</li> <li>• Sturdy mounting system that holds up to the roughest terrain</li> </ul>	Standard Cargo Bed	LinQ® Pivoting Rack <b>715009465</b>	Adventure Roof Rack <b>715007186</b>
<b>LinQ ACCESSORIES WITH 16" BASE</b> <ul style="list-style-type: none"> <li>• LinQ anchors mounted 16 inches apart, center-to-center.</li> <li>• Lower loading capacity than the LinQ with 36" base accessories.</li> <li>• Can be used on Can-Am ATV and SxS vehicles, Can-Am Spyder and Ryker vehicles, Sea-Doo watercraft and Ski-Doo snowmobiles.</li> </ul>			
<b>NEW LinQ Rigid Cooler 4.7 US Gal (18 L)</b> 715010491	Central position: No further requirements	LinQ Base Installation Kit <b>715008125</b> (1 set needed/accessory)	LinQ Base Installation Kit <b>715008125</b> (1 set needed/accessory)
<b>NEW LinQ Cooler 5.3 US Gal (20 L)</b> 295101257 • Gray	Other positions: LinQ Base Installation Kit <b>715008125</b> (1 set needed/accessory)		
<b>LinQ 11.4 US Gal (43 L) Cooler</b> 715007825 • Black 715009276 • Gray	Central position: No further requirements	No compatibility	No compatibility
<b>LinQ 4.2 Gal Cooler</b> 295100698 • White 219400964 • Black	Central position: No further requirements (fit on stock mounted LinQ anchors)  Other positions: LinQ Base Installation Kit <b>715008125</b> (1 set needed/accessory)	LinQ Base Installation Kit <b>715008125</b> (1 set needed/accessory)	LinQ Base Installation Kit <b>715008125</b> (1 set needed/accessory)
<b>LinQ Tool Kit</b> 715006829			
<b>LinQ Tool Box</b> 715008111			
<b>LinQ SR 5.5 Gal (21 L) Bag</b> 860202449			
<b>LinQ 4.5 Gal (17 L) Sport Bag</b> 860202447			
<b>LinQ Modular Box</b> 715005494 • (10 L) 715007112 • (20 L) 715006830 • (30 L)			
<b>LinQ Roll-Top Bag</b> 715008110			
<b>LinQ 26 US Gal (100 L) Explorer Bag</b> 295101016			
<b>LinQ 5.3 US Gal (20 L) Semi-Rigid Cooler</b> 295101252			
<b>LinQ ACCESSORIES WITH 36" BASE</b> <ul style="list-style-type: none"> <li>• Mount on LinQ racks often used by Can-Am ORV vehicles.</li> <li>• Higher loading capacity than the LinQ with 16" base accessories.</li> <li>• Usage is limited to Can-Am ORV vehicles.</li> </ul>			
<b>LinQ Trunk Box (87 L) – G3L</b> 715009312	No further requirements (fit on stock mounted LinQ anchors)	LinQ Base Installation Kit <b>715008125</b> (2 sets needed/accessory)	LinQ Base Installation Kit <b>715008125</b> (2 sets needed/accessory)
<b>LinQ Cargo Box (53 L)</b> 715006997			
<b>LinQ Low Profile Box (63 L)</b> 715007827			
<b>LinQ Cargo Basket (90 L)</b> 715005274			
<b>LinQ 9.2 Gal (35 L) Cooler</b> 715006998			
<b>LinQ CARGO ACCESSORIES</b>			
<b>LinQ Trunk Box (96 L)</b> 715007182	No further requirements (fit on stock mounted LinQ anchors)	No compatibility	No compatibility
<b>LinQ Side Cargo Boxes (13.5 L)</b> 715007372			
<b>LinQ HOLDERS</b>			
<b>LinQ Gear Grips</b> 715005340	No further requirements	LinQ Base Installation Kit <b>715008125</b> (1 set needed)	Side wall installation LinQ Adapters <b>715003058</b>
<b>LinQ Tool Holder</b> 715007358			

The LinQ system is BRP's game-changing, tool-free cargo solution. Snap gear on or off in seconds. No fuss, no rattle, just rock-solid mounting on any terrain.

# LINQ SYSTEM ADVANTAGE

## ORIGINAL LinQ SYSTEM

Handles medium- to large-sized gear with two anchor setups: the 16" base for standard accessories and the 36" base for racks and serious payloads.

## LinQ LITE

Made for smaller items, lightweight gear you can hang from rails or vertical mounts.



## LINQ ACCESSORIES WITH 16" BASE

### NEW LinQ Rigid Cooler 4.7 US Gal (18 L)

Maverick R, Maverick R MAX

■ 715010491 • Black

\$394.04



- Versatile LinQ 16" configuration fits many vehicles.
- Durable rotomolded rigid construction.
- Molded-in handles for quick installation and removal.
- High quality insulation for optimal ice retention.
- Sealed lid for airtight, weather-tight closure.
- Ergonomic and secure latch system offers excellent sealing.
- 4.7 US gal (18 L) capacity.
- See table for installation location and requirements.

### NEW LinQ Cooler 5.3 US Gal (20 L)

Maverick R, Maverick R MAX

■ 295101257 • Gray

\$409.99



- LinQ-mounted for fast, easy and secure storage.
- Locks in place with just a quarter turn.
- High-quality insulation for optimal ice retention.
- Keeps ice cold for 5 days.
- Rotomolded construction for exceptional rigidity and durability.
- Sealed lid for airtight, weather-tight closure.
- Rigid handles make transportation easy.
- Horizontal locking handles allow for installation of LinQ Lite accessories.
- Holds thirty-four 355 ml cans.
- 5.3 US gal (20 L) capacity.
- Exterior dimensions: 21" L x 15" W x 14" H (52 cm L x 38 cm W x 35 cm H).
- Interior dimensions: 15" L x 10" W x 9" H (39 cm L x 26 cm W x 23 cm H).
- LinQ Base Installation Kit (715008125) is required for installation.
- See table for installation location and requirements.

### NEW LinQ 5.3 US Gal (20 L) Semi-Rigid Cooler

Maverick R, Maverick R MAX

■ 295101252

\$265.99



- 5.3 US gal (20 L) of insulated, water-resistant capacity.
- Quick, easy and secure LinQ system installation.
- Attaches with one set of LinQ fasteners.
- Single-day-use soft cooler.
- Mesh pocket on top of the lid.
- Zippered pocket under the lid for quick and easy access.
- Removable interior for easy cleaning.
- Carry handles for easy transport.
- Can contain twelve 355 ml cans.
- Dimensions: 19" L x 13" W x 10" H.
- See table for installation location and requirements.

<b>LinQ 11.4 US Gal (43 L) Cooler</b>	Maverick R, Maverick R MAX	<ul style="list-style-type: none"> <li>■ <b>715007825</b> - Black</li> <li>■ <b>715009276</b> - Gray</li> </ul>	<b>\$638.99</b>
---------------------------------------	----------------------------	---	-----------------



- Versatile LinQ 16" configuration fits many vehicles.
- High quality injection-molded impact resistant polypropylene outer shell for exceptional durability.
- High quality insulation for optimal ice retention.
- Thicker insulation on bottom to isolate vehicle heat.
- 11.4 US gal (43 L) capacity.
- LinQ-mounted for fast, easy, secure storage.
- Locks in place with only a quarter turn.
- Rigid handles make transportation easy.
- Horizontal locking handles allow installation of LinQ Lite accessories.
- Dry-basket included to protect items.
- Drain plug at the bottom to evacuate water.
- New ergonomic and secure latch system offers excellent sealing.
- Possibility to lock the cooler with a padlock.
- See table for installation location and requirements.

<b>LinQ Modular Box</b>	Maverick R, Maverick R MAX	<ul style="list-style-type: none"> <li><b>715005494</b> - (10 L)</li> <li><b>715007112</b> - (20 L)</li> <li><b>715006830</b> - (30 L)</li> </ul>	<ul style="list-style-type: none"> <li><b>\$148.99</b></li> <li><b>\$170.49</b></li> <li><b>\$191.49</b></li> </ul>
-------------------------	----------------------------	---	---



- Allows stacking of other modular boxes to always have the right gear accessible.
- Always have the right box size to fit everything.
- Can be installed on any LinQ base with a 16" width.
- See table for installation location and requirements.

<b>Thermal Insert for LinQ Modular Box (10 L)</b>	Maverick R, Maverick R MAX	<b>219401110</b>	<b>\$63.99</b>
---	----------------------------	------------------	----------------



- Insulated liner.
- Fits very well in the LinQ Modular Box (10 L).
- Can contain seven 355 ml cans.
- Keeps ice cold for one day.
- Interior dimensions: 9" L x 17" W x 2½" H.

<b>LinQ Tool Box</b>	Maverick R, Maverick R MAX	<b>715008111</b>	<b>\$191.49</b>
----------------------	----------------------------	------------------	-----------------



- High precision injected HDPE construction provides rigidity and durability.
- 5 gal (19 L) maximum capacity.
- Weather-resistant, sealed and lockable cover.
- Easy one-second on/off tool-less system.
- All the benefits of LinQ—simple, fast and secure.
- See table for installation location and requirements.

<b>LinQ Tool Kit</b>	Maverick R, Maverick R MAX	<b>715006829</b>	<b>\$352.99</b>
----------------------	----------------------------	------------------	-----------------



- Includes:
  - Cutter pliers
  - Long-nose pliers
  - Locking pliers
  - Ratchet wrench ¾" drive
  - 6" ratchet extension
  - Integrated CVT belt storage location (belt not included)
  - Long-socket 19 mm ¾" drive - 6 pts
  - Socket 18 mm ¾" drive
  - Long-socket 17 mm ¾" drive - 6 pts
  - Socket 15 mm ¾" drive
  - Socket 13 mm ¾" drive
  - Socket 10 mm ¾" drive
  - Socket 8 mm ¾" drive
  - Socket Torx T40 ¾" drive
  - Socket Torx T30 ¾" drive
  - Socket Torx T20 ¾" drive
  - Breaker bar ¾" drive
  - Combination Wrench set:
    - Wrench 19 mm
    - Wrench 18 mm
    - Wrench 15 mm
  - Wrench 13 mm
  - Wrench 10 mm
  - Wrench 8 mm
- See table for installation location and requirements.

<b>LinQ 4.5 Gal (17 L) Sport Bag</b>	Maverick R, Maverick R MAX	<b>860202447</b>	<b>\$223.49</b>
--------------------------------------	----------------------------	------------------	-----------------



- All the benefits of LinQ—simple, fast and secure.
- 17 liter (4.5 US gallon) capacity.
- Thermoformed bag base in HDPE (High Density Polyethylene) providing rigidity and durability.
- Rigid bottom, semi-rigid top.
- Easy one-second on/off tool-less system.
- See table for installation location and requirements.

<b>SR 5.5 Gal (21 L) LinQ Bag</b>	Maverick R, Maverick R MAX	<b>860202449</b>	<b>\$244.99</b>
-----------------------------------	----------------------------	------------------	-----------------



- All the benefits of LinQ—simple, fast and secure.
- Semi-rigid expandable bag.
- 5.5 gal (21 L) capacity.
- Utilizes LinQ mounting system (Patent US 8777531 and US 8875830).
- Easy one-second on/off tool-less system.
- See table for installation location and requirements.

<b>LinQ Roll-Top Bag</b>	Maverick R, Maverick R MAX	<b>715008110</b>	<b>\$244.99</b>
--------------------------	----------------------------	------------------	-----------------



- Fully waterproof roll-top dry bag will securely store and confine your equipment.
- LinQ mounted using heavy-duty rigid plastic base.
- High capacity storage solution (40 L).
- Bottom foam liner for additional equipment protection.
- Integrated handle for easy transportation on/off the vehicle.
- Dimensions: 14" L x 19" W x adjustable H.
- See table for installation location and requirements.

<b>LinQ Explorer Bag</b>	Maverick R, Maverick R MAX	<b>295101016</b>	<b>\$478.99</b>
--------------------------	----------------------------	------------------	-----------------



- 26 gal (100 L) of watertight storage.
- Installs in seconds with tool-less LinQ accessory system.
- Dedicated essentials compartment for registration, license, insurance and more.
- Exclusive D.E.S.S.™ key storage.
- External quick-access pocket for small items like keys and wallets.
- Turns into a backpack when you get off your machine.
- Collapsible if not fully packed with straps on both sides.
- Dimensions: 26" L x 18" W x 14" H.

## LinQ ACCESSORIES WITH 36" BASE

<b>LinQ Trunk Box (87 L) – G3L</b>	Maverick R, Maverick R MAX	<b>715009312</b>	<b>\$564.49</b>
------------------------------------	----------------------------	------------------	-----------------



- Weatherproof polyethylene rear cargo box compatible on the rear rack.
- Storage capacity of 23 gal (87 L).
- Optimized shape of the cargo box base to fit the G3L rear rack perfectly.
- Lockable with a lock on the front of the box (2 keys included).
- Easy to install, easy to remove using the LinQ system.
- Installation in LinQ 36" configuration.
- Requires the installation of the Stopper Kit 715008895 included with the accessory.
- See table for installation location and requirements.

<b>LinQ 9.2 Gal (35 L) Cooler</b>	Maverick R, Maverick R MAX	<b>715006998</b>	<b>\$641.99</b>
-----------------------------------	----------------------------	------------------	-----------------



- LinQ-mounted for efficient and secure storage, locked in place with only a quarter turn.
- Easy to install, easy to remove using the LinQ system.
- Installation in LinQ 36" configuration.
- Made of polyethylene for exceptional rigidity and durability.
- Storage capacity of 35 L.
- Lock the cooler on the vehicle using the LinQ Lock (860201968).
- Premium-quality foam insulation for optimal ice retention.
- Option to add a 5-slot LinQ Lite Rail on the side and at the rear of the cooler.
- A dry basket is included to protect your food from water.
- Drain plug at the bottom to get rid of excess water.
- The new ergonomic and resistant latch system ensures the top is tightly sealed.
- Innovative way to hold 12 cans (355 ml).
- Molded-in handles for quick installation and removal.
- See table for installation location and requirements.

<b>LinQ Cargo Box (53 L)</b>	Maverick R, Maverick R MAX	<b>715006997</b>	<b>\$425.99</b>
------------------------------	----------------------------	------------------	-----------------



- Made of polyethylene.
- Storage capacity of 14 gal (53 L).
- Easy to install and remove with the LinQ system.
- New ergonomic and resistant latch system offers excellent sealing.
- Possibility to install LinQ 16" accessories on the cover and increase the cargo capacity.
- Ability to install Tool Holders (715008896) on the box.
- Lockable with a lock on the front of the box (2 keys included).
- See table for installation location and requirements.

<b>LinQ Low Profile Box (63 L)</b>	Maverick R, Maverick R MAX	<b>715007827</b>	<b>\$425.99</b>
------------------------------------	----------------------------	------------------	-----------------



- Made of impact-resistant injected polypropylene and weatherproof, this box has a storage capacity of 63 L.
- LinQ-mounted for efficient and secure storage, it is locked in place with only a quarter turn. Easy to install, easy to remove using the LinQ system.
- Can be installed in several 16" configurations, or in a 36" configuration.
- LinQ 16" accessories can be installed on the cover to increase cargo capacity.
- Easily carried with the rigid handle. The anti-vibration system prevents the handle from moving while riding.
- Support feet at hinge level so the box can stand on its own.
- The compact design allows for maximum rear field of vision.
- Features a lock on the front of the box (two keys included).
- See table for installation location and requirements.

<b>LinQ Cargo Basket (90 L)</b>	Maverick R, Maverick R MAX	<b>715005274</b>	<b>\$255.49</b>
---------------------------------	----------------------------	------------------	-----------------



- Made of polyethylene.
- Storage capacity of 23 gal (90 L).
- Easy to install and remove with the LinQ system.
- Can already be installed on your vehicle thanks to the stock mounted LinQ anchor.
- 6 handles on the contour to easily install bungee cords.
- Ability to install Tool Holders (715008896) on the basket.
- See table for installation location and requirements.

## LinQ CARGO ACCESSORIES

<b>LinQ Trunk Box (96 L)</b>	Maverick R, Maverick R MAX	<b>715007182</b>	<b>\$510.99</b>
------------------------------	----------------------------	------------------	-----------------



- Weatherproof box made of impact-resistant injected polypropylene reinforced with glass fiber.
- Features a maximum storage capacity of 96 L and 15 kg.
- Easy to install, easy to remove with the LinQ system.
- Can already be installed on your vehicle thanks to the stock mounted LinQ anchor.
- Ability to install in conjunction with the LinQ Side Cargo Boxes (13.5 L) for a complete cargo solution.
- Not compatible with LinQ Pivoting Rack (715009465) and Adventure Roof Rack (715007186).
- See table for installation location and requirements.

<b>LinQ Side Cargo Boxes (13.5 L)</b>	Maverick R, Maverick R MAX	<b>715007372</b>	<b>\$372.49</b>
---------------------------------------	----------------------------	------------------	-----------------

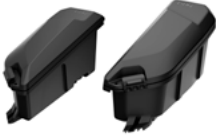

- Weatherproof box made of impact-resistant injected polypropylene reinforced with glass fiber.
- Features a maximum storage capacity of 13.5 L each and 5 kg.
- Easy to install, easy to remove thanks to the LinQ system.
- Possibility of installing up to two LinQ 16" accessories between the LinQ Side Cargo Boxes (13.5 L).
- Ability to install in conjunction with the LinQ Trunk Box (96 L) for a complete cargo solution.
- Not compatible with LinQ Pivoting Rack (715009465) and Adventure Roof Rack (715007186).
- See table for installation location and requirements.

## LinQ HOLDERS

<b>NEW LinQ Lite Action Camera Holder</b>	Maverick R, Maverick R MAX	<b>295101139</b>	<b>\$51.99</b>
---	----------------------------	------------------	----------------



- LinQ Lite attachment system for cameras.
- Provides great vantage points to capture photos and videos.
- Offers 360-angle positioning for perfect filming and taking photos.
- Designed to hold devices securely.
- Fast, easy attachment and removal.

<b>NEW LinQ Lite Device Holder</b>	Maverick R, Maverick R MAX	<b>715009201</b>	<b>\$191.69</b>
------------------------------------	----------------------------	------------------	-----------------



- Made with strong magnets that you can trust while riding through rough terrain.
- Includes everything needed for installation on your favorite electronic devices: 2 pre-assembled Can-Am plates with 3M multi-surface adhesive.
- 360° adjustment for an improved driving experience and immersion.
- Secure LinQ Lite attachment allows you to install/remove the holder in seconds.
- Robust plastic and aluminum construction allows for the right fit and easy installation.
- Compatible with the Cellphone Holder (715008786).
- To keep a good vision while driving, we recommend using this device for smartphones only.

<b>LinQ Tool Holder</b>	Maverick R, Maverick R MAX	<b>715007358</b>	<b>\$63.99</b>
-------------------------	----------------------------	------------------	----------------



- Ultra-versatile tool holder.
- Convenient swivel-latch allows tools to be stored in any orientation.
- Sold in pairs.

<b>LinQ Gear Grips</b>	Maverick R, Maverick R MAX	<b>715005340</b>	<b>\$160.49</b>
------------------------	----------------------------	------------------	-----------------



- Durable and flexible grips provide a custom fit for a variety of items from 1" to 4" (2.5 cm to 10 cm) in diameter.
- Heavy-duty design for carrying bows, fishing poles, rakes, farm tools and more.
- Quick-release button opens grip quickly for easy access to gear.
- Heavy-duty base system built for the toughest adventures.
- Make transporting your tools a snap by combining the LinQ Gear Grips with the LinQ system.
- 360° orientation.
- Sold in pairs.

## LinQ MOUNTING

<b>LinQ Adapter</b>	Maverick R, Maverick R MAX	<b>715003058</b>	<b>\$36.99</b>
---------------------	----------------------------	------------------	----------------



- Sold in pack of 4.
- Allows the installation of the LinQ Tool Holder on the Adventure Roof Rack.

<b>LinQ Base Installation Kit</b>	Maverick R, Maverick R MAX	<b>715008125</b>	<b>\$31.99</b>
-----------------------------------	----------------------------	------------------	----------------

- Unique mounting fastener usable on any LinQ system accessory.
- Included: 2 cargo LinQ bases and hardware.



<b>LinQ Lock</b>	Maverick R, Maverick R MAX	<b>860201968</b>	<b>\$66.99</b>
------------------	----------------------------	------------------	----------------

- Simple way to securely lock most LinQ accessories.
- Lock cover protects lock from the elements.
- Corrosion resistant.
- Pack of 1, includes 2 keys.
- Not compatible with LinQ 4.2 US Gal (16 L) Cooler, LinQ Tool Box, LinQ Tool Holder or LinQ Gear Grips.



<b>Spare Tire Ratchet Tie-Downs</b>	Maverick R, Maverick R MAX	<b>280000955</b>	<b>\$35.49</b>
-------------------------------------	----------------------------	------------------	----------------

- 3-way ratcheting tie-down strap with loop ends.
- Designed to securely hold spare tires on accessories equipped with integrated spare tire attachment points.
- Adjustable to accommodate most common UTV tire sizes.
- Ratchet and junction ring made of durable zinc-plated steel.
- Required for spare tire attachment on Adventure Roof Rack.



# RACKS & STORAGE

## RACKS

<b>LinQ Pivoting Rack</b>	Maverick R, Maverick R MAX	<b>715009465</b>	<b>\$909.49</b>
---------------------------	----------------------------	------------------	-----------------

- Strong and durable, the LinQ Pivoting Rack helps keep cargo securely in place.
- Anti-corrosion coating with durable powder coat finish.
- Gas cylinder pivoting action, locks in the open position.
- Possibility of installing up to three LinQ 16" accessories on top of the rack.
- Compatible with LinQ accessories for installation under the rack.
- Features anchor points for the spare-tire attachment.
- Spare Tire Tie-Downs sold separately.



<b>Adventure Roof Rack</b>	Maverick R	<b>715007186</b>	<b>\$766.99</b>
	Maverick R MAX	<b>715008073</b>	<b>\$1,497.99</b>

- The ideal cargo solution. Pack all the gear you need to take on any off-road experience.
- Built using lightweight 1.25" (3.2 cm) diameter steel tubing.
- Supports loads of up to 75 lb (34 kg).
- This roof rack features a height adjustment setting to precisely accommodate a stock roof or a roof with Cold Air Roof Scoop.
- Integrated mounting points for lights.
- Features anchor points for a spare tire attachment.
- Can be completed with LinQ Adapter (715003058) on the side.
- The Spare Tire Tie-Downs sold separately.
- Sport Roof (715008074) is required for installation on Maverick R MAX.



## STORAGE

<b>Center Console Bag</b>	Maverick R MAX	<b>715007895</b>	<b>\$191.49</b>
---------------------------	----------------	------------------	-----------------

- These weather-resistant bags hold your gear safely and securely while you ride.
- Extra storage solution for front and rear passenger.
- Accessible from front and rear seating position.
- Attach the bag between the seats to maximize unused space and increase the vehicle's cargo capacity.
- Volume 23 L.
- Dedicated pocket for goggles.
- Detachable side pouches for additional storage/garbage.
- Clear side pockets for cellphones.



<b>Shoulder Storage Bag</b>	Maverick R, Maverick R MAX	<b>715007371</b>	<b>\$138.49</b>
	<ul style="list-style-type: none"> <li>This weather-resistant bag holds your gear safely and securely while you ride.</li> <li>Attach the bag between the seats to maximize unused space and increase the vehicle's cargo capacity.</li> <li>This bag has a 1.5 gal (6 L) capacity and is equipped with outer netting compartments and a flexible inner net to hold items in place.</li> <li>The thermoformed base creates a semi-rigid structure to ease installation.</li> <li>Its soft construction makes the bag flexible enough to fit odd-shaped loads.</li> </ul>		
<b>Overhead Storage Bag</b>	Maverick R, Maverick R MAX	<b>715007379</b>	<b>\$170.49</b>
	<ul style="list-style-type: none"> <li>This weather-resistant bag holds your gear safely and securely while you ride.</li> <li>Makes smart use of the overhead space and increases the vehicle's cargo capacity by 2.3 gal (9 L).</li> <li>The thermoformed base attaches to the roof for easy bag installation and the soft construction makes the bag flexible enough to fit oddly shaped loads.</li> <li>Features a hanging function for easier access to the items in the bag and an integrated net for even more storage space.</li> <li>Contains two sections: a fixed bag and a detachable bag that can be carried.</li> <li>Easily access your smartphone using the touchscreen-compatible clear front pocket.</li> </ul>		
<b>Rear Upper Door Storage Bags</b>	Maverick R MAX	<b>715007893</b>	<b>\$159.49</b>
	<ul style="list-style-type: none"> <li>Weather-resistant bags hold your gear safely and securely while you ride.</li> <li>Door bags fit in the upper door opening to increase your vehicle's cargo space.</li> <li>Each bag is designed as a 1.3 gal (5 L) capacity pocket and is equipped with inner netting compartments.</li> <li>Thermoformed base attaches to the doors, allowing the bags to be installed.</li> <li>Its soft construction makes the bag flexible enough to fit odd-shaped loads.</li> <li>Added elbow cushions for extra comfort.</li> <li>Sold in pairs.</li> </ul>		
<b>Upper Door Storage Bags</b>	Maverick R, Maverick R MAX	<b>715008065</b>	<b>\$159.49</b>
	<ul style="list-style-type: none"> <li>These weather-resistant bags hold your gear safely and securely while you ride.</li> <li>The door bags fit in the upper door opening to increase your vehicle's cargo space.</li> <li>Each bag is designed as a 1.3 gal (5 L) capacity pocket and is equipped with inner netting compartments.</li> <li>The thermoformed base attaches to the doors, allowing the bags to be installed.</li> <li>Its soft construction makes the bag flexible enough to fit odd-shaped loads.</li> <li>Added elbow cushions for extra comfort.</li> <li>Sold in pairs.</li> </ul>		
<b>Lower Door Storage Bags</b>	Maverick R, Maverick R MAX	<b>715007324</b>	<b>\$159.49</b>
	<ul style="list-style-type: none"> <li>These weather-resistant bags hold your gear safely and securely while you ride.</li> <li>The door bags fit in the lower door opening to increase the vehicle's cargo space.</li> <li>Each bag is designed as a 1.3 gal (5 L) capacity pocket and equipped with inner netting compartments.</li> <li>The thermoformed base attaches to the doors, allowing the bags to be installed.</li> <li>Its soft construction makes the bag flexible enough to fit odd-shaped loads.</li> <li>Added cushions for extra comfort.</li> <li>Sold in pairs.</li> <li>Not compatible with Door Speakers (Level 5 Audio System).</li> </ul>		
<b>Passenger Storage Seat Bag</b>	Maverick R, Maverick R MAX	<b>715008080</b>	<b>\$265.99</b>
	<ul style="list-style-type: none"> <li>This weather-resistant bag holds your gear safely and securely while you ride.</li> <li>Bag settling on the passenger's seat to increase the vehicle's cargo capacity.</li> <li>This bag features a 14.5 gal (55 L) storage capacity and is divided into two compartments.</li> <li>The top compartment is insulated to keep your beverages cold and includes two cup holders.</li> <li>Additional pocket inside for additional storage, such as a cell phone.</li> <li>The bottom compartment is accessible from both sides and serves as a large pocket for storing various items.</li> <li>The detachable pocket at the front of the bag can be used as a garbage bag.</li> </ul>		
<b>Back Panel Storage Net</b>	Maverick R, Maverick R MAX	<b>715008312</b>	<b>\$42.49</b>
	<ul style="list-style-type: none"> <li>Storage net behind the passenger's seat for more storage.</li> </ul>		
<b>Bed Side Doors</b>	Maverick R, Maverick R MAX	<b>715009154</b>	<b>\$127.99</b>
	<ul style="list-style-type: none"> <li>Creates a storage solution out of the rear bed cavities of the unit.</li> <li>Perfect for housing trail and safety items that remain on the vehicle.</li> <li>Includes two Bed Side Doors, one for each side.</li> </ul>		



# SMART ACCESSORIES

Powered by the ACM, SMART Accessories respond automatically to speed, steering, and other sensor data, adjusting light output, behavior, and function in real time.

## A RESPONSE SYSTEM THAT TAKES TECH TO THE NEXT LEVEL.

### ACM

This is the brain of the SMART Ecosystem. It reads multiple sensors on the vehicle and translates the reading into actions for the accessories.

### 10.25" TOUCHSCREEN DISPLAY

When your vehicle is equipped with the 10.25" touchscreen display, it allows you to control up to 19 accessories at the same time.

### SMART CONTROL CENTER

Allows you to quickly access SMART Accessories (can be used with or without the 10.25" touchscreen display).

### SMART ACCESSORIES

Accessories designed to execute multiple functions depending on the input from the ACM.



# ACM & SMART ACCESSORIES

## ACCESSORY CONTROL MODULE (ACM)

### Accessory Control Module

Maverick R, Maverick R MAX  
(except X rc models)

715010097

\$593.99



- Bringing the SMART to accessories using live vehicle ECU information to maximize your accessory experience.
- Connect your accessories to the 10.25" Color Touchscreen Display.
- Easy accessory installation (plug and play).
- Creates an ecosystem that makes installing accessories quicker and easier.
- Includes ACM Front Harness to connect front-mounted SMART accessories to the Accessory Control Module (two auxiliary connectors available).
- Requires ACM Rear Harness (715009268) to connect rear-mounted SMART accessories to the Accessory Control Module.

### Rear ACM Harness

(Not illustrated)

Maverick R, Maverick R MAX

715009268

\$485.99

- Required to connect rear-mounted accessories and rear chase lights to the ACM.
- Creates an ecosystem that makes installing accessories quicker and easier.
- Five auxiliary connectors are available.

### NEW X rc Roof Harness

Maverick R, Maverick R MAX  
(X rc models only)

715010620

\$30.99



- Electric harness required to hook up and operate Roof Lights with ACM.
- Required only for Maverick R X rc.

### SMART Control Center for ACM

Maverick R, Maverick R MAX

715010834

\$534.99



- Control accessories with the selection of different modes, the illuminated halo around the button indicates the active mode.
- Icons illuminate when accessories are activated.
- Make accessory control changes without having to take your eyes off the trail by choosing the accessory button required (quick access).
- All Front LED Off button to turn off all front lights with one click. Remembers the last programmed setups when this button is pressed again.
- 6 pre-programmed buttons (Light Bars, PowerFlip Windshield, All Front LED Off, Corner Lights) and 10 programmable buttons to customize according to the accessories installed.
- Requires Accessory Control Module.

## SMART ACCESSORIES

### NEW SMART 10" (25 cm) LED Light Bar

Maverick R, Maverick R MAX

715008745

\$374.49



- The perfect combination of powerful white and selective yellow LEDs.
- The selective yellow LEDs are ideal for driving in low visibility conditions.
- The light is composed of 16 white LEDs and 8 yellow LEDs.
- Spot and Flood combo beam.
- The side lens design provides highly effective wide-angle illumination.
- The white LEDs produce 8,100 raw lumens and the selective yellow 2,640 raw lumens, delivering stunning lighting performance.
- The lens is made from hard-coated polycarbonate.
- IP67 and IP69k submersible and pressure washer safe.
- Switch options: Off, Low and High. Color change by flicking the switch quickly.
- SMART options: Off, Low, High, color change and SMART Automatic Mode.
- SMART MODE: Intensity increase or decreases and Spot/Flood ratio varies according to the speed of the vehicle with the installation of the Accessory Control Module (ACM).
- Accessory Control Module (715010097) is required for SMART functionality.
- Wiring Harness (715009886) is required for on/off function when ACM is not installed. Sold separately.
- See table for installation and requirements.

<b>NEW SMART 40" (102 cm) LED Light Bar</b>	Maverick R, Maverick R MAX	<b>715008747</b>	<b>\$1,069.99</b>
---	----------------------------	------------------	-------------------



- The perfect combination of powerful white or selective yellow LEDs.
  - The selective yellow LEDs are ideal for driving in low visibility conditions.
  - The light is composed of 64 white LEDs and 32 yellow LEDs.
  - Spot and Flood combo beam.
  - The side lens design provides highly effective wide-angle illumination.
  - The white LEDs produce 32,000 raw lumens and the selective yellow 10,560 raw lumens, delivering stunning lighting performance.
  - The lens is made from hard-coated polycarbonate.
  - IP67 and IP69k submersible and pressure washer safe.
- Switch options: Off, Low and High. Color change by flicking the switch quickly.
  - SMART options: Off, Low, High, color change and SMART Automatic Mode.
  - SMART MODE: Intensity increases or decreases and Spot/Flood ratio varies according to the speed of the vehicle with the installation of the Accessory Control Module (ACM).
  - Accessory Control Module (715010097 or 715010620) is required for SMART functionality
  - Requires LED Light Bar Mounts (715003529) or mounts directly to some Can-Am audio roofs.
  - See table for installation location and requirements.

<b>SMART Particle Separator</b>	Maverick R, Maverick R MAX	<b>715007187</b>	<b>\$481.49</b>
---------------------------------	----------------------------	------------------	-----------------



- Filters up to 96% of the dust prior to air intake.
- Fan speed adjusts with vehicle speed/RPM when equipped with ACM (Accessory Control Module).
- Mounts directly to the stock air intake duct.
- Air intake tube (706600403) is currently required for installation.
- IP68 fan.
- Requires Particle Separator Harness (715008890) when not equipped with the ACM.
- Keeps your air filter clean longer.
- Maintains engine performance.

<b>SMART Integrated LED Roof Light</b>	Maverick R, Maverick R MAX	<b>715007322</b>	<b>\$1,309.99</b>
--	----------------------------	------------------	-------------------

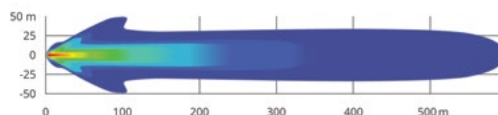

- Mounted under the roof for a signature look.
  - Windshield compatible except PowerFlip Windshield (715009900).
  - Intensity varies (increases or decreases) according to the speed of the vehicle with the installation of the Accessory Control Module (ACM) (Spot/Flood ratio).
  - Spot/Flood combo beam.
- 22,100 lumens.
  - Off/Low/High (switch activated).
  - Off/Low/High/SMART Automatic Mode (Accessory Control Module (ACM) activated).
  - Accessory Control Module (715010097 or 715010620) is required for SMART functionality.
  - Electric Harness (715008209) required to hook up and operate the Integrated LED Roof Light (715007322) for on/off function when ACM is not installed. Sold separately.

<b>SMART Integrated LED Hood Light</b>	Maverick R, Maverick R MAX	<b>715007378</b>	<b>\$372.49</b>
--	----------------------------	------------------	-----------------

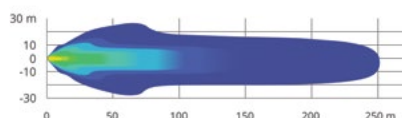

- Mounted flush inside the hood scoop for a signature look.
  - Intensity varies (increases or decreases) according to the speed of the vehicle with the installation of the Accessory Control Module (ACM) (Spot/Flood ratio).
  - Spot/Flood combo beam.
- 5,250 lumens.
  - Off/Low/High (switch activated).
  - Off/Low/High/SMART Automatic Mode (Accessory Control Module (ACM) activated).
  - Accessory Control Module (715010097) is required for SMART functionality.
  - Wiring Harness (715008211) required for on/off function when ACM is not installed. Sold separately.

<b>SMART Integrated LED Side Mirror Lights</b>	Maverick R, Maverick R MAX	<b>715007185</b>	<b>\$342.49</b>
--	----------------------------	------------------	-----------------

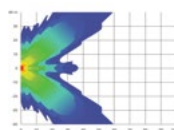

- Light up corners.
  - Increase the width of the beams and illuminate the wheels for increased visibility.
  - Wide flood beam.
  - 3,000 lumens for each light.
- Left and right dynamic lighting with Accessory Control Module (ACM) install. Follow steering wheel input.
  - Accessory Control Module (715010097) is required for SMART functionality.
  - Require Aluminum Side Mirrors (715007363).
  - Electric Harness required (715008212) to hook up and operate the Integrated LED Side Mirror Lights for on/off function when ACM is not installed. Sold separately.

**SMART LED Chase Lights**

Maverick R, Maverick R MAX

**715007727**

**\$705.99**



- Designed by Can-Am to make you visible to vehicles riding behind you, especially in dusty or harsh conditions.
- Four modes available:
  - Trail Mode: serves as a taillight and as a brake light.
  - Chasing Mode: displays amber light pattern and serves as a brake light.
  - Work Mode: white light to light up your cargo bed.
  - Reverse Mode (when connected with Accessory Control Module (ACM)): serves as a back up light.
- Modular to allow installation with rear roll cage mounted accessories.
- Plug-and-play installation with the Accessory Control Module (ACM).
- Accessory Control Module (715010097) and Rear ACM Harness (715009268) are required for SMART functionality.
- Electric Harness (715008210) required to hook up and operate the LED Chase Lights (715007727) for a non-smart function when ACM is not installed.
- The Cold Air Roof Scoop limits the performance of the Chase Lights to only the two outside portions and not the center.

**SMART PowerFlip Intermittent Windshield Wiper & Washer Kit**

Maverick R, Maverick R MAX

**715008555**

**\$748.99**



- Washer fluid dispenser is perfectly concealed on the vehicle.
- Must be installed with the PowerFlip Windshield (sold separately).
- SMART and fixed intermittence wiper speed feature available when the kit is installed in combination with ACM.
- Electric Harness required (715008855) to hook up and operate the Wiper & Washer Kits when ACM is not installed (sold separately).

**SMART Intermittent Wiper & Washer Kit**

Maverick R, Maverick R MAX

**715007173**

**\$745.49**



- An ideal way to keep your windshield clear in the rain, or while riding through mud and water.
- The wiper mechanism and washer fluid dispenser are perfectly concealed on the vehicle.
- The wiper and washer fluid dispenser installs at the bottom of the windscreen for maximum visibility.
- For use on glass or hardcoated windshields.
- SMART and fixed intermittence wiper speed feature available when the kit is installed in combination with ACM.
- Electric Harness (715008855) required to hook up and operate the Wiper & Washer Kit (715007173) for on/off function when ACM is not installed.

# LIGHTS

## CAN-AM LIGHTS

### CAN-AM LIGHTS WITH ACM

		2 CHOOSE YOUR LIGHTS					
1 CHOOSE YOUR MOUNT POINT		SMART Integrated LED Roof Light 715007322	SMART Integrated LED Hood Light 715007378	SMART Integrated LED Side Mirror Lights 715007185	SMART LED Chase Lights 715007727	SMART 40" (102 cm) LED Light Bar 715008747	SMART 10" (25 cm) LED Light Bar 715008745
SMART FUNCTIONALITY	Vehicle Integrated	Accessory Control Module 715010097 or X rc Roof Harness 715010620 (X rc models only)	Accessory Control Module 715010097	Aluminum Side Mirrors 715007363 + Accessory Control Module 715010097	Accessory Control Module 715010097 + Rear ACM Harness 715009268	No compatibility	
	Desert Front Bumper (715007311, 715007691 or 715009926)	No compatibility	No compatibility	No compatibility	No compatibility	No compatibility	Accessory Control Module 715010097 *Not compatible with Accessory Control Module 715009796
	Trail Front Bumper (715010071, 715010072 or 715009925)					No compatibility	
	Sport Roof with Light Support Bar (715003529)					Accessory Control Module 715010097 or X rc Roof Harness 715010620 (X rc models only) *Not compatible with Accessory Control Module 715009796	
	Audio Roof (no additional bracket needed)					No compatibility	
Adventure Roof Rack (715007186, 715008073)	No compatibility						

### CAN-AM LIGHTS WITHOUT ACM

		2 CHOOSE YOUR LIGHTS					
1 CHOOSE YOUR MOUNT POINT		SMART Integrated LED Roof Light 715007322	SMART Integrated LED Hood Light 715007378	SMART Integrated LED Side Mirror Lights 715007185	SMART LED Chase Lights 715007727	SMART 40" (102 cm) LED Light Bar 715008747	SMART 10" (25 cm) LED Light Bar 715008745
ON/OFF FUNCTIONALITY	Vehicle Integrated	Integrated LED Roof Light Wiring Harness 715008209	Integrated LED Hood Light Wiring Harness 715008211	Aluminum Side Mirrors 715007363 + Integrated LED Side Mirror Lights Wiring Harness 715008212	LED Chase Lights Wiring Harness 715008210	No compatibility	No compatibility
	Desert Front Bumper (715007311, 715007691 or 715009926)	No compatibility	No compatibility	No compatibility	No compatibility		Lights Wiring Harness 715009886
	Trail Front Bumper (715010071, 715010072 or 715009925)						
	Sport Roof with Light Support Bar (715003529)						No compatibility
	Audio Toof (no additional bracket needed)						No compatibility
Adventure Roof Rack (715007186, 715008073)	No compatibility						

\*All lights are intended for off-road use only.

# BAJA LIGHTS

## BAJA LIGHTS WITH ACM

1 CHOOSE YOUR MOUNT POINT	2 CHOOSE YOUR LIGHTS				
	40" (102 cm) Baja Designs OnX6 Arc LED Light Bar 710006818	10" (25 cm) Baja Designs OnX6 LED Light Bar 710006819	Baja Designs XL Sport LED Lights 710006821	Baja Designs Squadron Sport LED Lights 710006820	Baja Designs XL80 LED Lights 710005041
<b>Front Bumper X rc</b> (71501008)	No compatibility	Front Bumper X rc Light Support <b>715010532</b> + LED Light Bars ACM Adaptor <b>715008213</b>	Front Bumper X rc Light Support <b>715010532</b> + LED Lights ACM Adaptor <b>715007715</b>		
<b>Desert Front Bumper</b> (715007311, 715007691 or 715009926)		LED Light Bars ACM Adaptor <b>715008213</b>	LED Lights ACM Adaptor <b>715007715</b>		
<b>Trail Front Bumper</b> (715010071, 715010072 or 715009925)		No compatibility	LED Lights ACM Adaptor <b>715007715</b> + X rc Roof Harness <b>715010620</b> (X rc models only)		
<b>Roof with Light Support Bar</b> (715003529)			No compatibility		
<b>Roof Light Mounting Kit – Low Position</b> (715008585)	LED Light Bars ACM Adaptor <b>715008213</b> + X rc Roof Harness <b>715010620</b> (X rc models only)	No compatibility			
<b>Roof Light Mounting Kit – High Position</b> (715007930)					

\*All Baja lights are not ACM compatible with Maverick R X rc models

## BAJA LIGHTS WITHOUT ACM

1 CHOOSE YOUR MOUNT POINT	2 CHOOSE YOUR LIGHTS				
	40" (102 cm) Baja Designs OnX6 Arc LED Light Bar 710006818	10" (25 cm) Baja Designs OnX6 LED Light Bar 710006819	Baja Designs XL Sport LED Lights 710006821	Baja Designs Squadron Sport LED Lights 710006820	Baja Designs XL80 LED Lights 710005041
<b>Front Bumper X rc</b> (71501008)	No compatibility	Front Bumper X rc Light Support <b>715010532</b> + Wiring Harness <b>715008863</b>	Front Bumper X rc Light Support <b>715010532</b> + Wiring Harness <b>715008865</b>		Front Bumper X rc Light Support <b>715010532</b> + Wiring Harness <b>715008863</b>
<b>Desert Front Bumper</b> (715007311, 715007691 or 715009926)		Wiring Harness <b>715008863</b>	Wiring Harness <b>715008865</b>	Wiring Harness <b>715008865</b>	Wiring Harness <b>715008863</b>
<b>Trail Front Bumper</b> (715010071, 715010072 or 715009925)					
<b>Roof with Light Support Bar</b> (715003529)					
<b>Roof Light Mounting Kit – Low Position</b> (715008585)	Wiring Harness <b>715008864</b>	No compatibility			
<b>Roof Light Mounting Kit – High Position</b> (715007930)					

### 4 ORDER

### ORDER ALL PART NUMBERS IN INTERSECTING BOX

\*Note: When installing more than one light kit, additional light power cable or mounting kit is required.

\*All lights are intended for off-road use only.

### 40" (102 cm) Baja Designs OnX6 Arc LED Light Bar

Maverick R, Maverick R MAX

710006818

\$2,149.99



29,000 lumens

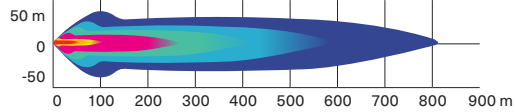

- 252 W light bar producing 29,000 lumens.
- Equipped with 24 Cree XM-L2 LEDs.
- Driving/Combo light pattern for smooth blend of light for both near field applications and distance.
- Designed for installation onto Light Support Bar equipped roofs.
- Requires Light Power Cable and Light Support Bar.

- ACM Adaptor required (715008213) to connect the Baja Designs LED Light Bars to the ACM harness.
- Electric Harness (715008864) required to hook up and operate the 40" (102 cm) Baja Designs OnX6 Arc LED Light Bar (710006818) for on/off function when ACM is not installed.
- Baja Designs Light Mounting Kit (715007930 or 715008585) is required for installation.
- See table for installation location and requirements.

### Baja Designs 10" (25 cm) OnX6 LED Light Bar

Maverick R, Maverick R MAX

710006819

\$591.49



12,460 lumens

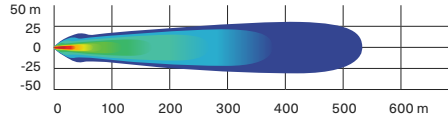

- 108 W light bar producing 12,460 lumens.
- Equipped with 6 Cree XM-L2 LEDs.
- Driving/combo light pattern for smooth blend of light for both near field applications and distance.
- Dual intensity (high/low) settings.

- Requires Baja Designs Light Power Cable.
- ACM Adaptor required (715008213) to connect the Baja Designs LED Light Bars to the ACM harness.
- Electric Harness (715008863) required to hook up and operate the 10" (25 cm) Baja Designs OnX6 LED Light Bar (710006819) for on/off function when ACM is not installed.
- See table for installation location and requirements.

### Baja Designs XL80 LED Lights

Maverick R, Maverick R MAX

710005041

\$1,117.99



9,500 lumens

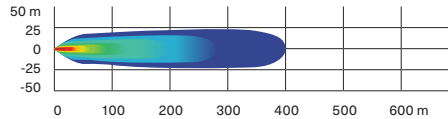

- 80 W per spot producing 9,500 lumens.
- Equipped with 4 Cree XHP50 LEDs per spot.
- Dual intensity (high/low) settings.
- Driving/combo light pattern for smooth blend of light for both near field applications and distance.
- Require Baja Designs Light Power Cable.
- Sold in pairs.

- Dimensions: 4.5" x 4.5" (11.4 cm x 11.4 cm).
- ACM Adaptor required (715007715) to connect the Baja Designs LED Lights to the ACM harness.
- Electric Harness (715008863) required to hook up and operate the Baja Designs XL80 LED Lights (710005041) for on/off function when ACM is not installed.
- See table for installation location and requirements.

### Baja Designs Squadron Sport LED Lights

Maverick R, Maverick R MAX

710006820

\$309.99



3,150 lumens

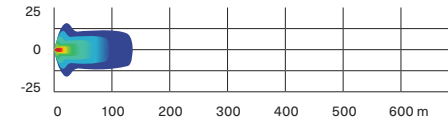

- 26 W per spot producing 3,150 lumens.
- Equipped with 4 Cree XP-G2 LEDs per spot.
- Wide cornering light pattern designed specifically for cornering, dust and/or fog conditions.
- Sold in pairs.

- Dimensions: 3" x 3" (7.6 cm x 7.6 cm).
- Electric Harness (715008865) required to hook up and operate the Baja Designs Squadron Sport LED Lights (710006820) for on/off function when ACM is not installed.
- See table for installation location and requirements.

### Baja Designs XL Sport LED Lights

Maverick R, Maverick R MAX

710006821

\$529.99



3,150 lumens

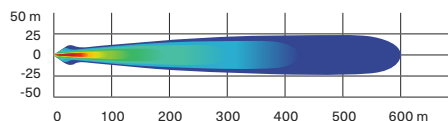

- 26 W per spot producing 3,150 lumens.
- Equipped with 4 Cree XP-G2 LEDs per spot.
- High Speed Spot features a longer and narrower beam focus for illumination farther down.
- Require Baja Designs Light Power Cable.
- Sold in pairs.

- Dimensions: 4.5" x 4.5" (11.4 cm x 11.4 cm).
- ACM Adaptor required (715007715) to connect the Baja Designs LED Lights to the ACM harness.
- Electric Harness (715008865) required to hook up and operate the Baja Designs XL Sport LED Lights (710006821) for on/off function when ACM is not installed.
- See table for installation location and requirements.

<b>NEW Dome Light</b>	Maverick R, Maverick R MAX	<b>715009228</b>	<b>\$96.49</b>
-----------------------	----------------------------	------------------	----------------



- Offers an optimal visibility in the cab and integrates perfectly with the vehicle.
- 160 lumens of soft white light ensure clear visibility of the surroundings.
- Built-in on/off button on the light.
- Wiring included.
- Can be installed on cage or Sport Roof.
- Not compatible with Audio Roof.

<b>NEW Front Bumper X rc Light Support</b>	Maverick R, Maverick R MAX	<b>715010532</b>	<b>\$80.24</b>
--	----------------------------	------------------	----------------



- Required for lights on Front Bumper X rc (715010008).
- Baja Design lights not compatible with the front bumper and ACM connector on X rc models.

<b>Baja Designs Light Mounting Kit – High Position</b>	Maverick R, Maverick R MAX	<b>715007930</b>	<b>\$159.49</b>
--	----------------------------	------------------	-----------------



- Mounting system for 40" (102 cm) Baja Designs OnX6 Arc LED Light Bar.
- Compatible with the Cold Air Roof Scoop.

<b>Baja Designs Light Mounting Kit – Low Position</b>	Maverick R, Maverick R MAX	<b>715008585</b>	<b>\$127.99</b>
---	----------------------------	------------------	-----------------



- Mounting system for 40" (102 cm) Baja Designs OnX6 Arc LED Light Bar.
- Not compatible with the Cold Air Roof Scoop.

<b>NEW Lights Wiring Harness</b>	Maverick R, Maverick R MAX	<b>715009886</b>	<b>\$85.59</b>
----------------------------------	----------------------------	------------------	----------------



- Power cable for installation of the SMART 10" (25 cm) LED Light Bar (715008745).



Rugged on the trails doesn't mean giving up the finer things. Treat yourself to exceptional sound on the move. Expertly tuned and DSP-calibrated, Can-Am's JL Audio-powered systems deliver precise equalization, time alignment, crossover filtering, bass boost, and more.

## YOUR SOUND, YOUR WAY

Choose the audio setup that matches your style.



### LEVEL 3

This option includes four 6.5" (165 mm) speakers (two dash and two surround speakers) PLUS a 10" under-seat 250-watt amplifier



### LEVEL 4

This option includes a full roof with a premium JL Audio system including four or six 7.7" coaxial speakers and a 500-watt amplifier



### LEVEL 5

This option includes six 6.5" (165 mm) speakers (two dash, two door, and two surround speakers) PLUS two 10" under-seat 250-watt amplifiers

## LEVEL UP WITH UPGRADES

Bring the thunder wherever you roll with an amplifier, rear speakers, or a subwoofer for even bigger sound on every ride.

# AUDIO SYSTEMS

<b>Can-Am JL Audio System – Level 5</b>	Maverick R, Maverick R MAX	<b>715007957</b>	<b>\$5,259.99</b>
---	----------------------------	------------------	-------------------



- Orchestrated for outstanding sound quality and calibrated to enhance your audio experience.
- Designed to fit the vehicle perfectly for a fully integrated look.
- Designed to be Can-Am tough in the most demanding riding conditions.
- Controlled by the 10.25" Color Touchscreen Display or by the Can-Am JL Audio Source Unit.
- Made using premium JL Audio components, including six 6.5" (165 mm) speakers (two dash, two door, and two surround speakers), as well as two 10" (254 mm) under-seat 250 W subwoofers that will enhance both the driver's and the passenger's experience.
- Speakers include an adjustable RGB LED cone illumination.
- Uses one MX500/4 to power up our six speakers, and one MX500/1 to feed the under-seat subwoofers.
- Complements the Can-Am Audio Roof – Level 4 (715007309).

<b>Can-Am JL Audio Roof – Level 4</b>	Maverick R	<b>715007309</b>	<b>\$3,609.99</b>
	Maverick R MAX	<b>715007967</b>	<b>\$5,669.99</b>



- Full roof with premium JL Audio System for Maverick R.
- Features fully sealed and waterproof components and construction.
- Easy to install and connect.
- Controlled by the 10.25" Color Touchscreen Display or by the Can-Am JL Audio Source Unit.
- Its weatherproof components include four 7.7" coaxial speakers (6 speakers for MAX) and a 500-watt amplifier.
- The system is expertly tuned for exceptional sound when you're riding in your Maverick R.
- Speakers include an adjustable RGB LED cone illumination, controlled via an app on your smartphone.
- When combined with the Can-Am Audio System – Level 3 (715007954) or Level 5 (715007957), it provides the ultimate sound experience.
- Not compatible with the Adventure Roof Rack (715008073 or 715007186).

<b>Can-Am JL Audio System – Level 3</b>	Maverick R, Maverick R MAX	<b>715007954</b>	<b>\$3,709.99</b>
---	----------------------------	------------------	-------------------



- Orchestrated for outstanding sound quality and calibrated to enhance your audio experience.
- Designed to fit the vehicle perfectly for a fully integrated look.
- Designed to be Can-Am tough in the most demanding riding conditions.
- Controlled by the 10.25" Color Touchscreen Display or by the Can-Am JL Audio Source Unit.
- Made using premium JL Audio components, including four 6.5" (165 mm) speakers (two dash and two surround speakers), and a 10" (254 mm) under-seat 250 W subwoofer that will enhance both the driver's and the passenger's experience.
- Uses one MX280/4 to power up our four speakers, and one MX500/1 to power up the under-seat subwoofer.
- Easy to install, with the option to add a second subwoofer (715007310).
- Complements the Can-Am Audio Roof – Level 4 (715007309).

<b>Can-Am JL Audio Roof Flip Kit</b>	Maverick R, Maverick R MAX	<b>715008164</b>	<b>\$532.49</b>
--------------------------------------	----------------------------	------------------	-----------------



- Combines with the Can-Am JL Audio Roof – Level 4 (715007309 or 715007967) for Flip option.
- Not compatible with the Cold Air Roof Scoop and the Roof Rack.

<b>Can-Am JL Audio Subwoofer</b>	Maverick R, Maverick R MAX	<b>715007310</b>	<b>\$779.99</b>
----------------------------------	----------------------------	------------------	-----------------



- Orchestrated for outstanding sound quality and calibrated to enhance your audio experience.
- Designed to be Can-Am tough in the most demanding riding conditions.
- Easy to install, this 10" (254 mm) under-seat 250 W subwoofer enhances both the driver's and the passenger's experience.
- When combined with the Can-Am audio system – Level 3 (715007954) or with the Can-Am Audio Roof – Level 4 (715007309), this premium JL Audio component creates the ultimate sound experience.
- To add one or two subwoofers to the Can-Am JL Audio Roof – Level 4, a Can-Am JL Audio Amplifier (715007714) is required.

<b>Can-Am JL Audio Amplifier</b>	Maverick R, Maverick R MAX	<b>715007714</b>	<b>\$669.99</b>
----------------------------------	----------------------------	------------------	-----------------



- Orchestrated for outstanding sound quality and calibrated to enhance your audio experience.
- Designed to fit the vehicle perfectly for a seamless integration.
- Designed to be Can-Am tough in the most demanding riding conditions.
- This MX500/1 is a premium JL Audio component and is used to feed one or two 250 W under-seat subwoofers.
- When combined with the Can-Am Audio Roof – Level 4 (715007309 or 715007967), it creates the ultimate sound experience.
- To add one or two subwoofers to the Can-Am JL Audio Roof – Level 4, this item is required.
- Easy to install, mounting support included.

### Can-Am JL Audio Source Unit

Maverick R, Maverick R MAX

715008230

\$749.99



- Required with all Can-Am JL levels installed on vehicles without 10.25" Color Touchscreen Display.
- Designed to fit the vehicle perfectly for a fully integrated look.
- AM/FM/Bluetooth compatible.

# ELECTRICAL & ELECTRONIC ACCESSORIES



### NEW GPS Module with Group Ride

(Not illustrated)

Maverick R, Maverick R MAX (2025 & prior)

860202990

\$174.99

- Enables live location sharing offline with friends and other vehicles around.
- Works without phone connection or cellular network, for a range of 1+ miles (1.6 km) depending on terrain.
- Embedded topographic maps and GPS function included.
- Module update has to be done in dealership.
- Included on all models with 10.25" Touchscreen Display.
- Retrofit for 2024 to 2025 vehicles with 10.25" Touchscreen Display.
- Requires 2 bolts M6x50 (250000749) for the retrofit on SSV.

### Electronic Device Holder

Maverick R, Maverick R MAX

715007176

\$340.99



- Increases the storage capacity of the glovebox by 1 gal (4 L), with secure magnetic adjustable support for your electronic device.
- Robust injected fiber-reinforced-polypropylene construction allows for the right fit and easy installation.
- Magnet 10 times stronger than any electronic device's weight, ride through rough terrain confidently.
- 2 possible positions for your electronic device: Portrait & Landscape. Adjustable support with 2 positions: facing the passenger or towards the driver for an improved driving experience and immersion.
- Includes everything needed for installation on your favorite electronic devices: 2 pre-assembled Can-Am plates with 3M multi-surface adhesive.

### Cellphone Holder

Maverick R, Maverick R MAX

715008786

\$106.99



- Water resistant door allows for perfect phone positioning.
- Features capacitive and resistive touch screen technology.
- Spring system in back plate automatically adjusts for thickness.
- Fits all cellphones within 7.2" (185 mm) x 3.3" (85 mm) x 0.6" (15 mm) dimensions.
- Works with almost all charger wires.
- Does not include cellphone or charging wires.
- Requires the Electronic Device Holder (715007176) for the Cellphone Holder to be supported.

### Color Touchscreen Display Protector

Vehicle equipped with 10.25 in. Color Touchscreen Display

860202680

\$27.49



- Provides additional protection for the digital display 10.25 in. touchscreen.
- Protects from scratches caused by ice, rocks, branches or other small debris.
- Anti-glare treatment to ensure good visibility.
- Includes cleaning tools: wet wipe, dry wipe, dust absorber and soft cloth.

### Auxiliary Battery Installation Kit

Maverick R, Maverick R MAX

715007837

\$427.99



- Allows the rider to add a second battery and/or replace the original battery (18 Ah or 30 Ah) for a dual battery setup. Recommended to power auxiliary electrical components such as sound systems or winches.
- Automatic rundown protection.
- Installs behind the seat for easy access.
- Requires the purchase of a second battery and battery hardware (not included and sold separately).
- Equipped with an electronic module that prevents the auxiliary electrical components from draining the original battery.

# WINCHES

## CAN-AM HD WINCHES

<b>Can-Am HD 4500 Winch</b>	Maverick R, Maverick R MAX	<b>715006416</b>	<b>\$384.99</b>
-----------------------------	----------------------------	------------------	-----------------



- Ergonomic clutch handle.
- Rugged all-steel gears and bushings for more torque and durability.
- Automatic 100% load-holding brake.
- Sealed solenoid for all-weather protection.
- Weather sealed corded remote and dash mounted switch.
- EC compliant.
- Pulling strength capability of 4,500 lb (2,041 kg).
- 43' of 1/4" (13.1 m of 6.3 mm) wire steel cable.
- Heavy-duty 4-way roller fairlead.
- Winch Electrical Harness (715008850), Winch Roller Fairlead Spacer (715008922) and winch compatible front bumper are required.

<b>Can-Am HD 4500-S Winch</b>	Maverick R, Maverick R MAX	<b>715006417</b>	<b>\$513.49</b>
-------------------------------	----------------------------	------------------	-----------------



- Ergonomic clutch handle.
- Rugged all-steel gears and bushings for more torque and durability.
- Automatic 100% load-holding brake.
- Sealed solenoid for all-weather protection.
- Weather-sealed corded remote and dash mounted switch.
- Pulling strength capability of 4,500 lb (2,041 kg).
- 50' of 1/4" (15.2 m of 6.35 mm) synthetic rope.
- Corrosion-proof aluminum Hawse fairlead.
- Winch Electrical Harness (715008850) and winch compatible front bumper are required.

## WINCH ACCESSORIES

<b>NEW Winch Cable Stopper</b>	All Can-Am HD Winches	<b>715009921</b>	<b>\$21.29</b>
--------------------------------	-----------------------	------------------	----------------



- Made of EPDM, a highly durable synthetic rubber.
- The Winch Cable Stopper isn't just for looks. It helps extend the life of the winch, rope, hook, and fairlead.
- In addition, the split design makes it easy to install.

<b>Can-Am HD Hawse Fairlead</b>	Can-Am HD Winch	<b>715006426</b>	<b>\$61.49</b>
---------------------------------	-----------------	------------------	----------------



- A must when upgrading your winch with a synthetic cable, this corrosion-proof aluminum Hawse fairlead will prevent the cable from snapping in a corner of a roller fairlead and from wearing prematurely due to the rough surface of the worn roller guide.
- Must be used with synthetic cables only.

<b>WARN Hawse Fairlead</b>	WARN Winch	<b>715007785</b>	<b>\$114.99</b>
----------------------------	------------	------------------	-----------------



- Double-powder-coated construction.
- To be used with synthetic winch cables only.

<b>Winch Roller Fairlead Spacer</b>	Maverick R, Maverick R MAX	<b>715008922</b>	<b>\$74.49</b>
-------------------------------------	----------------------------	------------------	----------------



- Required when using a Winch and Roller Fairlead with a wire cable.
- Made of aluminum, with an anti-corrosion finish.

<b>Synthetic Winch Cable</b>	Can-Am HD Winch	<b>715006430</b>	<b>\$158.99</b>
	WARN Winch	<b>715007783</b>	<b>\$169.99</b>



- 50' of 1/4" (15.2 m of 6.35 mm) synthetic cable for Can-Am HD winches.
- Can-Am HD Hawse Fairlead (715006426) is required when upgrading to a synthetic cable to avoid premature cable damage and wear.
- WARN Hawse Fairlead (715007785) is required when upgrading to a synthetic cable to avoid damage and premature wear of the cable.

<b>Wire Rope Replacement</b>	Can-Am HD Winch	<b>705014978</b>	<b>\$23.99</b>
	WARN Winch	<b>715006699</b>	<b>\$82.99</b>



- 43' of 1/4" (14.3 m of 6.3 mm) wire rope for Can-Am HD Winch.
- 55' of 1/4" (16.8 m of 6.35 mm) wire rope for WARN winch kit.
- 4,500 lb (2,041 kg) pulling strength.

<b>Synthetic Cable Extension</b>		<b>715001120</b>	<b>\$174.99</b>
----------------------------------	--	------------------	-----------------



- Lightweight ¼" (6.35 mm) diameter, easy to handle and won't rattle in cargo box.
- Easily attaches to winch cable to provide additional 50' (15.2 m) of distance.
- 4,500 lb (2,041 kg) single line capacity.

<b>Winch Electrical Harness</b> <i>(Not illustrated)</i>	Maverick R, Maverick R MAX	<b>715008850</b>	<b>\$193.49</b>
---	----------------------------	------------------	-----------------

- Required for winch installation.

<b>NEW Wireless Winch Remote</b>	With Can-Am HD Winch	<b>715008286</b>	<b>\$159.74</b>
----------------------------------	----------------------	------------------	-----------------



- On/Off and Winch In / Winch Out buttons with LED indicator light.
- Large Winch In / Winch Out buttons for easy activation with gloves.
- Ergonomic remote handle shape with a trigger-like holding protrusion.
- Quick and easy to install, thanks to a wiring harness with an integrated antenna and all necessary mounting hardware.
- Allows you to operate your winch from anywhere within a 50' (15.2 m) radius, increasing your recovery options.
- All components are IP67 sealing rated.
- The remote also floats in case it's dropped during a deep water recovery.
- Dash and handlebar mounting options.
- Compatible with all Can-Am HD winches.

<b>Wired Remote Control</b>	Can-Am HD Winch†	<b>715006504</b>	<b>\$26.49</b>
-----------------------------	------------------	------------------	----------------



- This kit allows winch owners to add the hand-held remote to vehicles with a stock winch.
- OEM stock winch is sold separately.
- EC compliant.

† Harness (710001023) is required to use remote control on a vehicle with a factory installed winch.

‡ Remote Control (710007050) and connection socket are included.

# PERFORMANCE

<b>SMART Particle Separator</b>	Maverick R, Maverick R MAX	<b>715007187</b>	<b>\$481.49</b>
---------------------------------	----------------------------	------------------	-----------------



- Filters up to 96% of the dust prior to air intake.
- Fan speed adjusts with vehicle speed/RPM when equipped with ACM (Accessory Control Module).
- Mounts directly to the stock air intake duct.
- Air Intake Tube (706600403) is currently required for installation.
- IP68 fan.
- Requires Particle Separator Harness (715008890) when not equipped with the ACM.
- Keeps your air filter clean longer.
- Maintains engine performance.

<b>Particle Separator Harness</b> <i>(Not illustrated)</i>	Maverick R, Maverick R MAX	<b>715008890</b>	<b>\$160.99</b>
---	----------------------------	------------------	-----------------

- Electric harness required to hook up and operate the Engine Air Intake Particle Separator (715007187) for on/off function when ACM is not installed.

<b>Lonestar Racing Fire Extinguisher Support</b>	Maverick R, Maverick R MAX	<b>715007320</b>	<b>\$229.99</b>
--	----------------------------	------------------	-----------------



- Quick-release support that lets riders slide the fire extinguisher out in a matter of seconds in an emergency.
- Made of billet anodized black aluminum.
- Fits 1.85" (4.7 cm) tubing.
- Can be fixed anywhere on the cage.
- Provides riders with the safety and security of knowing they have dependable emergency equipment on board.
- Comes with both billet mounts, quick-pull pin, mounting plate and two clamps.
- Fire extinguisher sold separately.
- "Lonestar Racing for Can-Am" branded.
- Incompatible with LinQ Pivoting Rack (715009465).

<b>Performance Air Filter by Twin AIR†</b>	Maverick R, Maverick R MAX	<b>715002895</b>	<b>\$116.49</b>
--	----------------------------	------------------	-----------------



- The best choice for the harshest conditions.
- Multiple staged oiled filtering foam for superior dust retaining capacity with high airflow.
- Washable and reusable.

<b>Digitally Encoded Security System (D.E.S.S.) Green Key</b>	Maverick R, Maverick R MAX	<b>710005232</b>	<b>\$63.49</b>
---	----------------------------	------------------	----------------



- Top-security anti-theft protection for your vehicle.
- Encrypted chip technology restricts access to your vehicle's electronic ignition system.
- One vehicle/one code.
- A vibration/shock-resistant ball-and-socket design that ensures a reliable connection.
- 2 programmable modes:
  - Normal mode: configurable, limits vehicle speed to 70 km/h (44 mph) and may have torque reduction.
  - Performance mode: No restrictions.

# CAN-AM MAVERICK X3



# CAN-AM MAVERICK X3



## COMPARATIVE CHART 114

## ACCESSORIES 120



Roofs	120
Soft Cab Enclosure	121
Windshields & Wind Protection	121
Mirrors	123
Doors	124
Seat Accessories	125
HMWPE Skid Plates	126
Bumpers & Guards	127
LinQ: Easy On, Easy Off Cargo	130
Racks & Storage	136
ACM & SMART Accessories	139
Lights	140
Audio & Communication Systems	147
Electrical & Electronic Accessories	148
Winches & Hitches	149
Performance	151
Apache Track Systems	154
ProMount Plows	157
Cover & Trailering	160









					
		MAVERICK X3 DS		MAVERICK X3 RS	
COLOR OPTIONS		Scandi Blue & Orange Crush Dusty Navy		Scandi Blue & Orange Crush Dusty Navy	
ENGINES	Type	Turbo 135 hp, Rotax® ACE (Advanced Combustion Efficiency) 900 cc turbocharged triple-cylinder engine, liquid-cooled and high-performance air filter	Turbo RR 200 hp, Rotax® ACE (Advanced Combustion Efficiency) 900 cc turbocharged triple-cylinder engine, liquid-cooled with integrated intercooler and high-performance air filter	Turbo 135 hp, Rotax® ACE (Advanced Combustion Efficiency) 900 cc turbocharged triple-cylinder engine, liquid-cooled and high-performance air filter	Turbo RR 200 hp, Rotax® ACE (Advanced Combustion Efficiency) 900 cc turbocharged triple-cylinder engine, liquid-cooled with integrated intercooler and high-performance air filter
	Fuel Delivery System	Intelligent Throttle Control (ITC™) with Electronic Fuel Injection (EFI)		Intelligent Throttle Control (ITC™) with Electronic Fuel Injection (EFI)	
	Transmission	pDrive primary and Quick Response System X (QRS-X) CVT with high airflow, L / H / N / R / P		pDrive primary and Quick Response System X (QRS-X) CVT with high airflow, L / H / N / R / P	
	Drive Train	Lockable front differential with exclusive Smart-Lok™** True 2WD/4WD with front diff. lock / 4WD TRAIL ACTIV / 4WD TRAIL		Lockable front differential with exclusive Smart-Lok™** True 2WD/4WD with front diff. lock / 4WD TRAIL ACTIV / 4WD TRAIL	
	Power Steering	High torque Tri-Mode Dynamic Power Steering (DPS™)		High torque Tri-Mode Dynamic Power Steering (DPS™)	
SUSPENSIONS	Front Suspension	Arched double A-arm with sway bar / 20 in. (50.8 cm) suspension travel		Arched double A-arm with sway bar / 22 in. (55.9 cm) suspension travel Trophy truck inspired arms	
	Front Shocks	SHOWA HPG piggyback 2.5 (dual-speed compression, dual-rate spring)		SHOWA HPG piggyback 2.5 (dual-speed compression, dual-rate spring)	
	Rear Suspension	4-link torsional trailing-arm X (TTX) with sway bar / 20 in. (50.8 cm) suspension travel		4-link torsional trailing-arm X (TTX) with sway bar / 22 in. (55.9 cm) suspension travel	
	Rear Shocks	SHOWA HPG piggyback 2.5 (dual-speed compression, dual-rate spring)		SHOWA HPG piggyback 2.5 (dual-speed compression, dual-rate spring)	
TIRES / WHEELS	XPS Trac Force 30 x 10 x 14 in. 14 in. cast-aluminum		XPS Trac Force 30 x 10 x 14 in. 14 in. cast-aluminum		
BRAKES	Front	Dual 262 mm disc brakes with hydraulic twin-piston calipers		Dual 262 mm disc brakes with hydraulic twin-piston calipers	
	Rear	Dual 248 mm disc brakes with hydraulic twin-piston calipers		Dual 248 mm disc brakes with hydraulic twin-piston calipers	
DIMENSIONS / CAPACITIES	Estimated Dry Weight	1,571 lb (713.3 kg)		1,698 lb (769.9 kg)	
	Chassis / Cage	Dual-phase 980 steel		Dual-phase 980 steel	
	L x W x H	132 x 64 x 65.4 in. (335.3 x 162.5 x 166.1 cm)		132 x 72.4 x 68.5 in. (335.3 x 183.9 x 174 cm)	
	Wheelbase	102 in. (259.1 cm)		102 in. (259.1 cm)	
	Ground Clearance	14 in. (35.6 cm)		16 in. (40.6 cm)	
	Rack Capacity	200 lb (91 kg) with LinQ® quick-attach		200 lb (91 kg) with LinQ® quick-attach	
	Storage Capacity	Total: 2.5 gal (9.4 L)		Total: 2.5 gal (9.4 L)	
	Fuel Capacity	10.5 gal (40 L)		10.5 gal (40 L)	
FEATURES	Gauge	4.5 in. digital display with keypad		4.5 in. digital display with keypad	
	Instrumentation	DC outlet (10 A)		DC outlet (10 A)	
	Anti-theft System	RF Digitally Encoded Security System (D.E.S.S.™) with Start/Stop button		RF Digitally Encoded Security System (D.E.S.S.™) with Start/Stop button	
	Lighting	Premium high-performance LED headlights LED taillights		Premium high-performance LED headlights LED taillights	
	Winch	N/A		N/A	
	Magneto	650 W	850 W	650 W	850 W
	Protection	Integrated front bumper Quarter-doors Full heavy-duty HMW plastic skid plate Rear tow hook		Integrated front bumper Quarter-doors Full heavy-duty HMW plastic skid plate Rear tow hook	



\*Smart-Lok was developed in conjunction with TEAM Industries, a market leader in the drive train industry.  
\*\*Smart-Shox was developed in conjunction with Tractive Industries, a market leader in the suspension industry.  
\*\*\*1-year BRP limited warranty. B.E.S.T. term available up to 30 months.

				
	MAVERICK X3 X	MAVERICK X3 X DS	MAVERICK X3 X RS	
<b>COLOR OPTIONS</b>	Granite Grey	Triple Black Dusty Navy	Triple Black Dusty Navy	
<b>ENGINES</b>	<b>Type</b>	Turbo	Turbo RR	
	<b>Fuel Delivery System</b>	135 hp, Rotax® ACE (Advanced Combustion Efficiency) 900 cc turbocharged triple-cylinder engine, liquid-cooled and high-performance air filter	200 hp, Rotax® ACE (Advanced Combustion Efficiency) 900 cc turbocharged triple-cylinder engine, liquid-cooled with integrated intercooler and high-performance air filter	200 hp, Rotax® ACE (Advanced Combustion Efficiency) 900 cc turbocharged triple-cylinder engine, liquid-cooled with integrated intercooler and high-performance air filter
	<b>Transmission</b>	Intelligent Throttle Control (ITC™) with Electronic Fuel Injection (EFI)	Intelligent Throttle Control (ITC™) with Electronic Fuel Injection (EFI)	Intelligent Throttle Control (ITC™) with Electronic Fuel Injection (EFI)
	<b>Drive Train</b>	pDrive primary and Quick Response System X (QRS-X) CVT with high airflow, L / H / N / R / P	pDrive primary and Quick Response System X (QRS-X) CVT with high airflow, L / H / N / R / P	pDrive primary and Quick Response System X (QRS-X) CVT with high airflow, L / H / N / R / P
	<b>Power Steering</b>	Lockable front differential with exclusive Smart-Lok™* True 2WD/4WD with front diff. lock / 4WD TRAIL ACTIV / 4WD TRAIL	Lockable front differential with exclusive Smart-Lok™* True 2WD/4WD with front diff. lock / 4WD TRAIL ACTIV / 4WD TRAIL	Lockable front differential with exclusive Smart-Lok™* True 2WD/4WD with front diff. lock / 4WD TRAIL ACTIV / 4WD TRAIL
	<b>Power Steering</b>	High torque Tri-Mode Dynamic Power Steering (DPS™)	High torque Tri-Mode Dynamic Power Steering (DPS™)	High torque Tri-Mode Dynamic Power Steering (DPS™)
<b>SUSPENSIONS</b>	<b>Front Suspension</b>	Arched double A-arm with sway bar / 20 in. (50.8 cm) suspension travel	Arched double A-arm with sway bar / 20 in. (50.8 cm) suspension travel	Arched double A-arm with sway bar / 22 in. (55.9 cm) suspension travel Trophy truck inspired arms
	<b>Front Shocks</b>	FOX® 2.5 PODIUM RC2¹ Piggyback with dual-speed compression and rebound adjustments	FOX® 2.5 PODIUM RC2¹ Piggyback with dual-speed compression and rebound adjustments OR FOX® 2.5 PODIUM¹ Piggyback with bypass and Smart-Shox™ technology featuring DDA Valve (Dynamic Damping Adjustment)	FOX® 2.5 PODIUM RC2¹ Piggyback with bypass, dual-speed compression and rebound adjustments OR FOX® 2.5 PODIUM¹ Piggyback with bypass and Smart-Shox™ technology featuring DDA Valve (Dynamic Damping Adjustment)
	<b>Rear Suspension</b>	4-link torsional trailing-arm X (TTX) with sway bar / 20 in. (50.8 cm) suspension travel	4-link torsional trailing-arm X (TTX) with sway bar / 20 in. (50.8 cm) suspension travel	4-link torsional trailing-arm X (TTX) with sway bar / 24 in. (61 cm) suspension travel
	<b>Rear Shocks</b>	FOX® 2.5 PODIUM RC2¹ Piggyback with dual-speed compression, rebound adjustments and bottom-out control	FOX® 2.5 PODIUM RC2¹ Piggyback with dual-speed compression, rebound adjustments and bottom-out control OR FOX® 3.0 PODIUM¹ Piggyback with bypass and Smart-Shox™ technology featuring DDA Valve (Dynamic Damping Adjustment)	FOX® 3.0 PODIUM RC2¹ with bypass, dual-speed compression and rebound adjustments OR FOX® 3.0 PODIUM¹ Piggyback with bypass and Smart-Shox™ technology featuring DDA Valve (Dynamic Damping Adjustment)
<b>TIRES / WHEELS</b>	<b>Front / Tires Wheels</b>	XPS Trac Force 30 x 10 x 14 in. 14 in. cast-aluminum	XPS Trac Force 30 x 10 x 14 in. 14 in. cast-aluminum beadlock	XPS Trac Force 32 x 10 x 15 in. 15 in. cast-aluminum beadlock
<b>BRAKES</b>	<b>Front</b>	Dual 262 mm disc brakes with hydraulic twin-piston calipers	Dual 262 mm disc brakes with hydraulic twin-piston calipers	Dual 262 mm disc brakes with hydraulic twin-piston calipers
	<b>Rear</b>	Dual 248 mm disc brakes with hydraulic twin-piston calipers	Dual 248 mm disc brakes with hydraulic twin-piston calipers	Dual 248 mm disc brakes with hydraulic twin-piston calipers
<b>DIMENSIONS / CAPACITIES</b>	<b>Estimated Dry Weight</b>	1,584 lb (843 kg)	1,579 lb (715.9 kg)	1,705 lb (773 kg)
	<b>Chassis / Cage</b>	Dual-phase 980 steel	Dual-phase 980 steel	Dual-phase 980 steel
	<b>L x W x H</b>	132 x 64 x 65.7 in. (335.3 x 162.5 x 166.9 cm)	132 x 64 x 65.7 in. (335.3 x 162.5 x 166.9 cm)	132 x 72.7 x 68.5 in. (335.3 x 184.7 x 174 cm)
	<b>Wheelbase</b>	102 in. (259.1 cm)	102 in. (259.1 cm)	102 in. (259.1 cm)
	<b>Ground Clearance</b>	14 in. (35.6 cm)	14 in. (35.6 cm)	16 in. (40.6 cm)
	<b>Rack Capacity</b>	XPS Trac Force 30 x 10 x 14 in.	200 lb (91 kg) with LinQ® quick-attach	200 lb (91 kg) with LinQ® quick-attach
	<b>Storage Capacity</b>	Total: 2.5 gal (9.4 L)	Total: 2.5 gal (9.4 L)	Total: 2.5 gal (9.4 L)
	<b>Fuel Capacity</b>	10.5 gal (40 L)	10.5 gal (40 L)	10.5 gal (40 L)
<b>FEATURES</b>	<b>Gauge</b>	4.5 in. wide digital display with keypad & 10.25 in. touchscreen display	7.6 in. digital display with keypad OR 4.5 in. wide digital display with keypad & 10.25 in. touchscreen display	7.6 in. digital display with keypad OR 4.5 in. wide digital display with keypad & 10.25 in. touchscreen display
	<b>Instrumentation</b>	DC outlet (10 A)	DC outlet (10 A)	DC outlet (10 A)
	<b>Anti-theft System</b>	RF Digitally Encoded Security System (D.E.S.S.™) with Start/Stop button	RF Digitally Encoded Security System (D.E.S.S.™) with Start/Stop button	RF Digitally Encoded Security System (D.E.S.S.™) with Start/Stop button
	<b>Lighting</b>	LED headlight LED signature LED taillights	LED headlight LED signature LED taillights	LED headlight LED signature LED taillights
	<b>Winch</b>	4,500 lb (2,041 kg) winch with synthetic cable	N/A	N/A
	<b>Magneto</b>	850 W	850 W	850 W
	<b>Protection</b>	Panoramic mirror Rear camera Full heavy-duty HMW plastic skid plate Quarter doors color match with filler Full hard roof Front bumper	Integrated front bumper Quarter-doors Full hard roof 4-point harness with shoulder pads Full heavy-duty HMW plastic skid plate Rear tow hook	Integrated front bumper Quarter-doors Full hard roof 4-point harness with shoulder pads Full heavy-duty HMW plastic skid plate Rear tow hook



\*Smart-Lok was developed in conjunction with TEAM Industries, a market leader in the drive train industry.  
\*\*Smart-Shox was developed in conjunction with Tractive Industries, a market leader in the suspension industry.  
\*\*\*1-year BRP limited warranty. B.E.S.T. term available up to 30 months.

				
	MAVERICK X3 X RC 64"	MAVERICK X3 X RC 72"	MAVERICK X3 X MR 64"	MAVERICK X3 X MR 72"
<b>COLOR OPTIONS</b>	Loft Green Satin	Loft Green Satin	Loft Green Satin	Loft Green Satin
<b>ENGINES</b>	<b>Type</b>	Turbo RR	Turbo RR	Turbo RR
		200 hp, Rotax® ACE (Advanced Combustion Efficiency) 900 cc turbocharged triple-cylinder engine, liquid-cooled with integrated intercooler and high-performance air filter	200 hp, Rotax® ACE (Advanced Combustion Efficiency) 900 cc turbocharged triple-cylinder engine, liquid cooled with integrated intercooler and high-performance air filter	200 hp, Rotax® ACE (Advanced Combustion Efficiency) 900 cc turbocharged triple-cylinder engine, liquid cooled with integrated intercooler, high-performance air filter and strategically positioned engine air intake
	<b>Fuel Delivery System</b>	Intelligent Throttle Control (ITC™) with Electronic Fuel Injection (EFI)	Intelligent Throttle Control (ITC™) with Electronic Fuel Injection (EFI)	Intelligent Throttle Control (ITC™) with Electronic Fuel Injection (EFI)
	<b>Transmission</b>	pDrive primary and Quick Response System X (QRS-X) CVT with high airflow, L / H / N / R / P	pDrive primary and Quick Response System X (QRS-X) CVT with high airflow, L / H / N / R / P	pDrive primary and Quick Response System X (QRS-X) CVT, high airflow with strategically positioned CVT air intake and exhaust, L / H / N / R / P
	<b>Drive Train</b>	Lockable front differential with exclusive Smart-Lok™ technology. True 4-mode traction system: 2WD / 4WD with front diff. lock / 4WD ROCK / 4WD TRAIL	Lockable front differential with exclusive Smart-Lok™ technology. True 4 modes traction system: 2WD / 4WD with front diff. lock / 4WD ROCK / 4WD TRAIL	Lockable front differential with exclusive Smart-Lok™ technology. True 4 modes traction system: 2WD / 4WD with front diff. lock / 4WD MUD / 4WD TRAIL
	<b>Power Steering</b>	High torque Tri-Mode Dynamic Power Steering (DPS™)	High torque Tri-Mode Dynamic Power Steering (DPS™)	High torque Tri-Mode Dynamic Power Steering (DPS™)
<b>SUSPENSIONS</b>	<b>Front Suspension</b>	Arched double A-arm with sway bar / 20 in. (50.8 cm) suspension travel	Arched double A-arm with sway bar / 22 in. (55.9 cm) suspension travel Trophy truck inspired arms	Arched double A-arm with sway bar / 20 in. (50.8 cm) suspension travel
	<b>Front Shocks</b>	FOX® 2.5 PODIUM Piggyback with QS3 <sup>1</sup> compression adjustment	FOX® 2.5 PODIUM RC2 <sup>1</sup> Piggyback with bypass, dual-speed compression and rebound adjustments	FOX® 2.5 PODIUM Piggyback with QS3 <sup>1</sup> compression adjustment
	<b>Rear Suspension</b>	4-link torsional trailing-arm X (TTX) with sway bar and arched lower links / 20 in. (50.8 cm) suspension travel	4-link torsional trailing-arm X (TTX) with sway bar and arched lower links / 24 in. (61 cm) suspension travel	4-link torsional trailing-arm X (TTX) with sway bar and arched lower links / 20 in. (50.8 cm) suspension travel
	<b>Rear Shocks</b>	FOX® 2.5 PODIUM Piggyback with QS3 <sup>1</sup> compression adjustment and bottom-out control	FOX® 3.0 PODIUM RC2 <sup>1</sup> with bypass, dual-speed compression and rebound adjustments	FOX® 2.5 PODIUM Piggyback with QS3 <sup>1</sup> compression adjustment and bottom-out control
<b>TIRES / WHEELS</b>	<b>Front / Tires Wheels</b>	XPS Hammer King 30 x 10 x 15 in. 15 in. cast-aluminum beadlock	XPS Hammer King 32 x 10 x 15 in. 15 in. cast-aluminum beadlock	XPS Swamp King 30 x 10 x 15 in. 15 in. cast-aluminum
<b>BRAKES</b>	<b>Front</b>	Dual 262 mm disc brakes with hydraulic twin-piston calipers	Dual 262 mm disc brakes with hydraulic twin-piston calipers	Dual 262 mm disc brakes with hydraulic twin-piston calipers
	<b>Rear</b>	Dual 248 mm disc brakes with hydraulic twin-piston calipers	Dual 248 mm disc brakes with hydraulic twin-piston calipers	Dual 248 mm disc brakes with hydraulic twin-piston calipers
<b>DIMENSIONS / CAPACITIES</b>	<b>Estimated Dry Weight</b>	1,693 lb (768.3 kg)	1,862 lb (845 kg)	1,730 lb (784.4 kg)
	<b>Chassis / Cage</b>	Dual-phase 980 steel	Dual-phase 980 steel	Dual-phase 980 steel
	<b>L x W x H</b>	133 x 65 x 66 in. (337.8 x 165.1 x 167.6 cm)	134.5 x 72.8 x 68.5 in. (341.6 x 184.9 x 174 cm)	133 x 66.7 x 66.1 in. (337.8 x 169.4 x 167.9 cm)
	<b>Wheelbase</b>	102 in. (259.1 cm)	102 in. (259.1 cm)	102 in. (259.1 cm)
	<b>Ground Clearance</b>	14 in. (35.6 cm)	16 in. (40.6 cm)	14 in. (35.6 cm)
	<b>Rack Capacity</b>	200 lb (91 kg) with LinQ® quick-attach	200 lb (91 kg) with LinQ® quick-attach	200 lb (91 kg) with LinQ® quick-attach
	<b>Storage Capacity</b>	Total: 2.5 gal (9.4 L)	Total: 2.5 gal (9.4 L)	Total: 2.5 gal (9.4 L)
	<b>Fuel Capacity</b>	10.5 gal (40 L)	10.5 gal (40 L)	10.5 gal (40 L)
<b>FEATURES</b>	<b>Gauge</b>	4.5 in. wide digital display with keypad & 10.25 in. touchscreen display	4.5 in. wide digital display with keypad & 10.25 in. touchscreen display	7.6 in. digital display with keypad
	<b>Instrumentation</b>	DC outlet (10 A)	DC outlet (10 A)	DC outlet (10 A)
	<b>Anti-theft System</b>	RF Digitally Encoded Security System (D.E.S.S.™) with Start/Stop button	RF Digitally Encoded Security System (D.E.S.S.™) with Start/Stop button	RF Digitally Encoded Security System (D.E.S.S.™) with Start/Stop button
	<b>Lighting</b>	LED headlight LED signature LED taillights	LED headlight LED signature LED taillights	LED headlight LED signature LED taillights
	<b>Winch</b>	4,500 lb (2,041 kg) winch with synthetic cable	4,500 lb (2,041 kg) winch with synthetic cable	4,500 lb (2,041 kg) winch with synthetic cable
	<b>Magneto</b>	850 W	850 W	850 W
	<b>Protection</b>	Front bumper Quarter-doors UHMWPE rock sliders HMWPE skid plates: Full heavy-duty with differential / under bumper / front and rear suspension arm Rear tow hook Trailing arm protector Lower A-arm protector	Front bumper Half-doors Full hard roof Intrusion bar 4-point harness with shoulder pads UHMWPE rock sliders HMWPE skid plates: Full heavy-duty with differential / under bumper / front and rear suspension arm Rear tow hook Trailing arm protector Lower A-arm protector	Front bumper Half-doors Front and rear tow hooks Full heavy-duty HMW plastic skid plate



\*Smart-Lok was developed in conjunction with TEAM Industries, a market leader in the drive train industry.  
\*\*Smart-Shox was developed in conjunction with Tractive Industries, a market leader in the suspension industry.  
\*\*\*1-year BRP limited warranty. B.E.S.T. term available up to 30 months.

					
		MAVERICK X3 MAX DS		MAVERICK X3 MAX RS	
COLOR OPTIONS		Scandi Blue & Orange Crush Dusty Navy		Scandi Blue & Orange Crush Dusty Navy	
ENGINES	Type	Turbo 135 hp, Rotax® ACE (Advanced Combustion Efficiency) 900 cc turbocharged triple-cylinder engine, liquid cooled and high-performance air filter	Turbo RR 200 hp, Rotax® ACE (Advanced Combustion Efficiency) 900 cc turbocharged triple-cylinder engine, liquid cooled with integrated intercooler and high-performance air filter	Turbo 135 hp, Rotax® ACE (Advanced Combustion Efficiency) 900 cc turbocharged triple-cylinder engine, liquid cooled and high-performance air filter	Turbo RR 200 hp, Rotax® ACE (Advanced Combustion Efficiency) 900 cc turbocharged triple-cylinder engine, liquid cooled with integrated intercooler and high-performance air filter
	Fuel Delivery System	Intelligent Throttle Control (ITC™) with Electronic Fuel Injection (EFI)		Intelligent Throttle Control (ITC™) with Electronic Fuel Injection (EFI)	
	Transmission	pDrive primary and Quick Response System X (QRS-X) CVT with high airflow, L / H / N / R / P		pDrive primary and Quick Response System X (QRS-X) CVT with high airflow, L / H / N / R / P	
	Drive Train	Lockable front differential with exclusive Smart-Lok™ True 2WD/4WD with front diff. lock / 4WD TRAIL ACTIV / 4WD TRAIL		Lockable front differential with exclusive Smart-Lok™ True 2WD/4WD with front diff. lock / 4WD TRAIL ACTIV / 4WD TRAIL	
	Power Steering	High torque Tri-Mode Dynamic Power Steering (DPS™)		High torque Tri-Mode Dynamic Power Steering (DPS™)	
SUSPENSIONS	Front Suspension	Arched double A-arm with sway bar / 20 in. (50.8 cm) suspension travel		Arched double A-arm with sway bar / 22 in. (55.9 cm) suspension travel Trophy truck inspired arms	
	Front Shocks	SHOWA HPG piggyback 2.5 (dual-speed compression, dual-rate spring)		SHOWA HPG piggyback 2.5 (dual-speed compression, dual-rate spring)	
	Rear Suspension	4-link torsional trailing-arm X (TTX) with sway bar / 20 in. (50.8 cm) suspension travel		4-link torsional trailing-arm X (TTX) with sway bar / 22 in. (55.9 cm) suspension travel	
	Rear Shocks	SHOWA HPG piggyback 2.5 (dual-speed compression, dual-rate spring)		SHOWA HPG piggyback 2.5 (dual-speed compression, dual-rate spring)	
TIRES/WHEELS	XPS Trac Force 30 x 10 x 14 in. 14 in. cast-aluminum		XPS Trac Force 30 x 10 x 14 in. 14 in. cast-aluminum		
BRAKES	Front	Dual 262 mm disc brakes with hydraulic twin-piston calipers		Dual 262 mm disc brakes with hydraulic twin-piston calipers	
	Rear	Dual 248 mm disc brakes with hydraulic twin-piston calipers		Dual 248 mm disc brakes with hydraulic twin-piston calipers	
DIMENSIONS / CAPACITIES	Estimated Dry Weight	1,835 lb (832 kg)		1,967 lb (891.9 kg)	
	Chassis / Cage	Dual-phase 980 steel		Dual-phase 980 steel	
	L x W x H	164 x 64 x 65.8 in. (416.6 x 162.5 x 167.1 cm)		164 x 72.4 x 68.5 in. (416.6 x 183.9 x 174 cm)	
	Wheelbase	135 in. (342.9 cm)		135 in. (342.9 cm)	
	Ground Clearance	13 in. (33 cm)		16 in. (40.6 cm)	
	Rack Capacity	150 lb (68 kg) with LinQ® quick-attach		150 lb (68 kg) with LinQ® quick-attach	
	Storage Capacity	Total: 3 gal (11.4 L)		Total: 3 gal (11.4 L)	
	Fuel Capacity	10.5 gal (40 L)		10.5 gal (40 L)	
FEATURES	Gauge	4.5 in. digital display with keypad		4.5 in. digital display with keypad	
	Instrumentation	DC outlet (10 A)		DC outlet (10 A)	
	Anti-theft System	RF Digitally Encoded Security System (D.E.S.S.™) with Start/Stop button		RF Digitally Encoded Security System (D.E.S.S.™) with Start/Stop button	
	Lighting	LED headlight LED taillights		LED headlight LED taillights	
	Winch	N/A		N/A	
	Magneto	650 W	850 W	650 W	850 W
	Protection	Integrated front bumper Quarter-doors Full heavy-duty HMW plastic skid plate Rear tow hook		Integrated front bumper Quarter-doors Full heavy-duty HMW plastic skid plate Rear tow hook	

\*Smart-Lok was developed in conjunction with TEAM Industries, a market leader in the drive train industry.  
\*\*Smart-Shox was developed in conjunction with Tractive Industries, a market leader in the suspension industry.  
\*\*\*1-year BRP limited warranty. B.E.S.T. term available up to 30 months.

				
	<b>MAVERICK X3 MAX X</b>	<b>MAVERICK X3 MAX X DS</b>	<b>MAVERICK X3 MAX X RS</b>	
<b>COLOR OPTIONS</b>	Granite Grey	Triple Black Dusty Navy	Triple Black Dusty Navy	
<b>ENGINES</b>	<b>Type</b>	Turbo	Turbo RR	Turbo RR
		135 hp, Rotax® ACE (Advanced Combustion Efficiency) 900 cc turbocharged triple-cylinder engine, liquid cooled and high-performance air filter	200 hp, Rotax® ACE (Advanced Combustion Efficiency) 900 cc turbocharged triple-cylinder engine, liquid cooled with integrated intercooler and high-performance air filter	200 hp, Rotax® ACE (Advanced Combustion Efficiency) 900 cc turbocharged triple-cylinder engine, liquid cooled with integrated intercooler and high-performance air filter
	<b>Fuel Delivery System</b>	Intelligent Throttle Control (ITC™) with Electronic Fuel Injection (EFI)	Intelligent Throttle Control (ITC™) with Electronic Fuel Injection (EFI)	Intelligent Throttle Control (ITC™) with Electronic Fuel Injection (EFI)
	<b>Transmission</b>	pDrive primary and Quick Response System X (QRS-X) CVT with high airflow, L / H / N / R / P	pDrive primary and Quick Response System X (QRS-X) CVT with high airflow, L / H / N / R / P	pDrive primary and Quick Response System X (QRS-X) CVT with high airflow, L / H / N / R / P
	<b>Drive Train</b>	Lockable front differential with exclusive Smart-Lok™** True 2WD/4WD with front diff. lock / 4WD TRAIL ACTIV / 4WD TRAIL	Lockable front differential with exclusive Smart-Lok™** True 2WD/4WD with front diff. lock / 4WD TRAIL ACTIV / 4WD TRAIL	Lockable front differential with exclusive Smart-Lok™** True 2WD/4WD with front diff. lock / 4WD TRAIL ACTIV / 4WD TRAIL
	<b>Power Steering</b>	High torque Tri-Mode Dynamic Power Steering (DPS™)	High torque Tri-Mode Dynamic Power Steering (DPS™)	High torque Tri-Mode Dynamic Power Steering (DPS™)
<b>SUSPENSIONS</b>	<b>Front Suspension</b>	Arched double A-arm with sway bar / 20 in. (50.8 cm) suspension travel	Arched double A-arm with sway bar / 20 in. (50.8 cm) suspension travel	Arched double A-arm with sway bar / 22 in. (55.9 cm) suspension travel Trophy truck inspired arms
	<b>Front Shocks</b>	FOX® 2.5 PODIUM RC2¹ Piggyback with dual-speed compression and rebound adjustments	FOX® 2.5 PODIUM RC2¹ Piggyback with dual-speed compression and rebound adjustments OR FOX® 2.5 PODIUM¹ Piggyback with bypass and Smart-Shox™ Technology featuring DDA Valve (Dynamic Damping Adjustment)	FOX® 2.5 PODIUM RC2¹ Piggyback with bypass, dual-speed compression and rebound adjustments OR FOX® 2.5 PODIUM¹ Piggyback with bypass and Smart-Shox™ Technology featuring DDA Valve (Dynamic Damping Adjustment)
	<b>Rear Suspension</b>	4-link torsional trailing-arm X (TTX) with sway bar / 20 in. (50.8 cm) suspension travel	4-link torsional trailing-arm X (TTX) with sway bar / 20 in. (50.8 cm) suspension travel	4-link torsional trailing-arm X (TTX) with sway bar / 22 in. (55.9 cm) suspension travel
	<b>Rear Shocks</b>	FOX® 2.5 PODIUM RC2¹ Piggyback with dual-speed compression, rebound adjustments and bottom-out control	FOX® 2.5 PODIUM RC2¹ Piggyback with dual-speed compression, rebound adjustments and bottom-out control OR FOX® 3.0 PODIUM¹ Piggyback with bypass and Smart-Shox™ Technology featuring DDA Valve (Dynamic Damping Adjustment)	FOX® 3.0 PODIUM RC2¹ with bypass, dual-speed compression and rebound adjustments OR FOX® 3.0 PODIUM¹ Piggyback with bypass and Smart-Shox™ Technology featuring DDA Valve (Dynamic Damping Adjustment)
<b>TIRES / WHEELS</b>	<b>Front / Tires</b> XPS Trac Force 30 x 10 x 14 in. 14 in. cast-aluminum	XPS Trac Force 30 x 10 x 14 in. 14 in. cast-aluminum beadlock	XPS Trac Force 32 x 10 x 15 in. 15 in. cast-aluminum beadlock	
<b>BRAKES</b>	<b>Front</b>	Dual 262 mm disc brakes with hydraulic twin-piston calipers	Dual 262 mm disc brakes with hydraulic twin-piston calipers	Dual 262 mm disc brakes with hydraulic twin-piston calipers
	<b>Rear</b>	Dual 248 mm disc brakes with hydraulic twin-piston calipers	Dual 248 mm disc brakes with hydraulic twin-piston calipers	Dual 248 mm disc brakes with hydraulic twin-piston calipers
<b>DIMENSIONS / CAPACITIES</b>	<b>Estimated Dry Weight</b>	1,838 lb (835.5 kg)	1,872 lb (848.7 kg)	1,958 lb (887.7 kg)
	<b>Chassis / Cage</b>	Dual-phase 980 steel	Dual-phase 980 steel	Dual-phase 980 steel
	<b>L x W x H</b>	164 x 64 x 66 in. (416.6 x 162.5 x 167.6 cm)	164 x 64 x 66 in. (416.6 x 162.5 x 167.6 cm)	165 x 72.7 x 68.5 in. (419.1 x 184.7 x 174 cm)
	<b>Wheelbase</b>	135 in. (342.9 cm)	135 in. (342.9 cm)	135 in. (342.9 cm)
	<b>Ground Clearance</b>	13 in. (33 cm)	13 in. (33 cm)	16 in. (40.6 cm)
	<b>Rack Capacity</b>	150 lb (68 kg) with LinQ® quick-attach	150 lb (68 kg) with LinQ® quick-attach	150 lb (68 kg) with LinQ® quick-attach
	<b>Storage Capacity</b>	Total: 3 gal (11.4 L)	Total: 3 gal (11.4 L)	Total: 3 gal (11.4 L)
	<b>Fuel Capacity</b>	10.5 gal (40 L)	10.5 gal (40 L)	10.5 gal (40 L)
<b>FEATURES</b>	<b>Gauge</b>	4.5 in. wide digital display with keypad & 10.25 in. touchscreen display	7.6 in. digital display with keypad OR 4.5 in. wide digital display with keypad & 10.25 in. touchscreen display	7.6 in. digital display with keypad OR 4.5 in. wide digital display with keypad & 10.25 in. touchscreen display
	<b>Instrumentation</b>	DC outlet (10 A)	DC outlet (10 A)	DC outlet (10 A)
	<b>Anti-theft System</b>	RF Digitally Encoded Security System (D.E.S.S.™) with Start/Stop button	RF Digitally Encoded Security System (D.E.S.S.™) with Start/Stop button	RF Digitally Encoded Security System (D.E.S.S.™) with Start/Stop button
	<b>Lighting</b>	LED headlight LED signature LED taillights	LED headlight LED signature LED taillights	LED headlight LED signature LED taillights
	<b>Winch</b>	4,500 lb (2,041 kg) winch with synthetic cable	N/A	N/A
	<b>Magneto</b>	850 W	850 W	850 W
	<b>Protection</b>	Panoramic mirror Front and rear cameras Full heavy-duty HMW plastic skid plate Quarter doors color match with filler Full hard roof Front bumper	Integrated front bumper Quarter-doors Full hard roof 4-point harness with shoulder pads Full heavy-duty HMW plastic skid plate Rear tow hook	Integrated front bumper Quarter-doors Full hard roof 4-point harness with shoulder pads Full heavy-duty HMW plastic skid plate Rear tow hook

\*Smart-Lok was developed in conjunction with TEAM Industries, a market leader in the drive train industry.  
\*\*Smart-Shox was developed in conjunction with Tractive Industries, a market leader in the suspension industry.  
\*\*\*1-year BRP limited warranty. B.E.S.T. term available up to 30 months.

		
	MAVERICK X3 MAX X MR	MAVERICK X3 MAX X RC
<b>COLOR OPTIONS</b>	Loft Green Satin	Loft Green Satin
<b>ENGINES</b>	<b>Type</b>	Turbo RR
	<b>Fuel Delivery System</b>	200 hp, Rotax® ACE (Advanced Combustion Efficiency) 900 cc turbocharged triple-cylinder engine, liquid cooled with integrated intercooler, high-performance air filter and strategically positioned engine air intake
	<b>Transmission</b>	Intelligent Throttle Control (iTC™) with Electronic Fuel Injection (EFI)
	<b>Drive Train</b>	pDrive primary and Quick Response System X (QRS-X) CVT, high airflow with strategically positioned CVT air intake and exhaust, L / H / N / R / P
	<b>Power Steering</b>	Lockable front differential with exclusive Smart-Lok™** technology. True 4-mode traction system: 2WD / 4WD with front diff. lock / 4WD MUD / 4WD TRAIL
		High torque Tri-Mode Dynamic Power Steering (DPS™)
<b>SUSPENSIONS</b>	<b>Front Suspension</b>	Arched double A-arm with sway bar / 22 in. (55.9 cm) suspension travel Trophy truck inspired arms
	<b>Front Shocks</b>	FOX® 2.5 PODIUM Piggyback with QS3® compression adjustment
	<b>Rear Suspension</b>	4-link torsional trailing-arm X (TTX) with sway bar and arched lower links / 22 in. (55.9 cm) suspension travel
	<b>Rear Shocks</b>	FOX® 2.5 PODIUM Piggyback with QS3® compression adjustment and bottom-out control
<b>TIRES/ WHEELS</b>	<b>Front / Tires</b>	XPS Swamp King 30 x 10 x 15 in. 15 in. cast-aluminum
	<b>Wheels</b>	XPS Hammer King 32 x 10 x 15 in. 15 in. cast-aluminum beadlock
<b>BRAKES</b>	<b>Front</b>	Dual 262 mm disc brakes with hydraulic twin-piston calipers
	<b>Rear</b>	Dual 248 mm disc brakes with hydraulic twin-piston calipers
<b>DIMENSIONS / CAPACITIES</b>	<b>Estimated Dry Weight</b>	2,025 lb (915.1 kg)
	<b>Chassis / Cage</b>	Dual-phase 980 steel
	<b>L x W x H</b>	165 x 74.2 x 68 in. (419.1 x 188.5 x 172.7 cm)
	<b>Wheelbase</b>	135 in. (342.9 cm)
	<b>Ground Clearance</b>	16 in. (40.6 cm)
	<b>Rack Capacity</b>	150 lb (68 kg) with LinQ® quick-attach
	<b>Storage Capacity</b>	Total: 3 gal (11.4 L)
	<b>Fuel Capacity</b>	10.5 gal (40 L)
<b>FEATURES</b>	<b>Gauge</b>	7.6 in. digital display with keypad
	<b>Instrumentation</b>	4.5 in. wide digital display with keypad & 10.25 in. touchscreen display
	<b>Anti-theft System</b>	DC outlet (10 A)
	<b>Lighting</b>	RF Digitally Encoded Security System (D.E.S.S.™) with Start/Stop button
	<b>Winch</b>	LED headlight LED signature LED taillights
	<b>Magneto</b>	4,500 lb (2,041 kg) winch with synthetic cable
	<b>Protection</b>	4,500 lb (2,041 kg) winch with synthetic cable
		850 W
	850 W	
	Front bumper Half-doors Full hard roof Intrusion bar 4-point harness with shoulder pads UHMWPE rock sliders UHMWPE skid plates. Full heavy duty with differential / under bumper / front and rear suspension arm Rear tow hook Trailing arm protector Lower A-arm protector	

\*Smart-Lok was developed in conjunction with TEAM Industries, a market leader in the drive train industry.  
\*\*Smart-Shox was developed in conjunction with Tractive Industries, a market leader in the suspension industry.  
\*\*\*1-year BRP limited warranty. B.E.S.T. term available up to 30 months.

# ROOFS

<b>Sport Roof</b>	Maverick X3	<b>715005521</b>	<b>\$479.99</b>
	Maverick X3 MAX	<b>715003750</b>	<b>\$889.99</b>



- Impact-resistant injected polypropylene.
- Excellent protection from the elements.
- Provides excellent downhill visibility.
- Windshield compatible.
- Standard on X rs model.
- Easy, tool-less installation and removal with quick-release ¼ turn fasteners and Velcro straps.

<b>ProVent Roof Module Kit</b>	Maverick X3, Maverick X3 MAX	<b>715005279</b>	<b>\$249.99</b>
--------------------------------	------------------------------	------------------	-----------------



- Provides fresh air in the cab area.
- Optimal performance with full cab enclosure.
- 4 vents provide infinite adjustment of air flow for driver and passenger.
- Filter and pre-filter to limit dust intrusion.
- Easy cleaning of filter and pre-filter.
- Patent pending water management system to keep water out of cabin while maintaining air flow.
- Outer plug closes air intake completely for winter or heavy weather.
- Sport Roof requires ProVent Module Adapter Kit.
- Not compatible with roof mounted LED bars, roof racks (715006225/715003868) or roof liners, Lonestar Roof, or Bimini tops.

<b>ProVent Roof Module Adapter Kit for Sport Roof</b> <i>(Not illustrated)</i>	Maverick X3	<b>715006199</b>	<b>\$98.99</b>
	Maverick X3 MAX	<b>715006371</b>	<b>\$98.99</b>

- Adapter for fitting ProVent Roof Module Kit onto Maverick X3.
- Includes roof adapter and hardware.
- Requires ProVent Roof Module Kit (715005279).

<b>Aluminum Roof</b>	Maverick X3	■ <b>715004224</b> • Black	<b>\$729.99</b>
		■ <b>715002900</b> • Silver	<b>\$639.99</b>



- Formed aluminum roof 0.09" (2.3 mm) thick.
- Durable and lightweight.
- Sporty look.
- Windshield compatible.
- Easy and tool-less installation.

<b>Bimini<sup>®</sup> Roof with Sun Visor</b>	Maverick X3	<b>715002901</b>	<b>\$382.99</b>
	Maverick X3 MAX	<b>715003749</b>	<b>\$414.99</b>



- Heavy-duty canvas made of UV-resistant solution-dyed polyester.
- Innovative soft top comes with a hard visor that allows for storage of rolled-up soft top.
- Easy, tool-less installation and removal with quick-release/turn fasteners and Velcro straps.

<b>Tinted Sun Visor</b>	Maverick X3, Maverick X3 MAX	<b>715007098</b>	<b>\$289.99</b>
-------------------------	------------------------------	------------------	-----------------



- Tinted polycarbonate construction.
- Extra protection for driver and passenger from the sun.
- Not compatible with Aluminum Roof, Audio Roof or Full Windshields.

<b>Lonestar Racing Aluminum Roof</b>	Maverick X3 produced after January 1, 2017	■ <b>715005507</b> • Black	<b>\$919.99</b>
	Maverick X3 MAX	■ <b>715005515</b> • Black	<b>\$1,659.99</b>



- 0.083" (2.1 mm) thick aluminum roof.
- Durable and lightweight.
- Enhances the vehicle's racing appearance thanks to an authentic sporty look combined with unique graphics.
- Offers you protection from the elements with a personalized touch.
- Lower profile than other roofs.
- Compatible with Lonestar Racing Light Bar Racks.
- Not compatible with LinQ<sup>®</sup> Pivoting Rack, Light Support Bar and Full Windshields.
- "Lonestar Racing for Can-Am" branded.
- Includes middle intrusion bars for installation.

# SOFT CAB ENCLOSURE

Soft Cab Enclosure	Maverick X3 (except X mr models)	715003754	\$2,459.99
	Maverick X3 MAX (except X mr models)	715003755	\$3,419.99



- Protection for rider and passenger from the elements.
- For added cabin comfort, complete your cab enclosure with Cab Seal Kit.
- Includes:
  - Bimini roof with sun visor
  - Full windshield — hardcoated
  - Upper soft door panels
  - Front lower door panels
  - Soft rear window

Cab Seal Kit <i>(Not illustrated)</i>	Maverick X3	715004433	\$52.99
	Maverick X3 MAX	715004434	\$35.99

- Prevents dirt, dust and wind infiltration in the cab area.
- Improves cabin comfort for driver and passenger.
- Recommended with Soft Cab Enclosures.

# WINDSHIELDS & WIND PROTECTION

## WINDSHIELDS

PowerFlip Windshield	Maverick X3, Maverick X3 MAX	715007097	\$1,559.99
----------------------	------------------------------	-----------	------------



- The PowerFlip Windshield is equipped with electric cylinders that allow the rider to adjust the windshield opening at the touch of a button.
- Windshield is made of hardcoated polycarbonate with a rubber seal contour and a tinted top section.
- Allows you to quickly adapt to changing conditions by adjusting the windshield as you go.
- Can be fully opened for optimal visibility and ventilation, fully closed for maximum protection from the elements, and in between, you have an infinite number of opening possibilities depending on protection, visibility and air flow preferences.
- Compatible with Can-Am roofs.

Windshield Wiper for PowerFlip Windshield	Maverick X3, Maverick X3 MAX	715006310	\$902.49
---	------------------------------	-----------	----------



- An ideal way to keep your windshield clear in rain or while riding through mud and water.
- Wiper from the top allows windshield pivoting. Includes single-speed wiper and washer-fluid dispenser.
- Wiper mechanism and washer-fluid dispenser perfectly concealed within the vehicle.
- Must be installed with the PowerFlip Windshield (sold separately).

Provent Windshield	Maverick X3, Maverick X3 MAX	715005277	\$1,019.99
--------------------	------------------------------	-----------	------------



- High-impact-resistant Quantum hardcoated polycarbonate full windshield.
- Controllable vents to manage air flow.
- Optimal performance with full cab enclosure.
- Channels air into the cabin, defogs windshield, fully closes to eliminate air flow.
- One upper vent and one lower vent with pre-filters.
- Formed polycarbonate construction for enhanced rigidity.
- Protects driver and passenger from the elements.
- Quick and easy tool-less installation or removal.
- Not compatible with wiper kits and Wet Sounds Stealth 6 Ultra HD Can-Am Edition Sound Bar.
- Upper vent channels air into the cabin.
- Lower vents defog windshield.
- Provides excellent optical clarity and better abrasion resistance.

Glass Windshield	Maverick X3, Maverick X3 MAX	715008859	\$1,189.99
------------------	------------------------------	-----------	------------



- Curved and laminated glass full windshield.
- Seals firmly against the cage and protects rider and passenger from the elements.
- Provides the best optical clarity and abrasion resistance.
- Must be used with Windshield Wiper & Washer Kit to maintain clear visibility during severe riding conditions, such as mud riding.
- Recommended to use with rear wind protection to maximize comfort for passenger.

<b>Glass Windshield with SMART Wiper &amp; Washer Kit</b>	Maverick X3, Maverick X3 MAX	<b>715008858</b>	<b>\$1,729.99</b>
---	------------------------------	------------------	-------------------



- Complete kit that includes a curved and laminated glass windshield with a single-speed wiper and washer fluid dispenser.
- Seals firmly against the cage and protects rider and passenger from the elements.
- An ideal way to keep your windshield clear in rain, or while riding through mud and water.
- Recommended to use with rear wind protection to maximize comfort for passenger.
- Smart and fixed intermittence wiper speed feature available when the kit is installed in combination with ACM.

<b>Full Windshield</b>	Maverick X3, Maverick X3 MAX	<b>715002907</b>	<b>\$549.99</b>
------------------------	------------------------------	------------------	-----------------



- High-impact-resistant durable polycarbonate full windshield.
- Formed polycarbonate construction for enhanced rigidity.
- Formulated to be non-yellowing, non-crazing, non-cracking with excellent UV resistance and optical clarity.
- Protects driver and passenger from the elements.
- Quick and easy tool-less installation or removal.
- Recommended to use with rear wind protection to maximize comfort for passenger.

<b>Full Windshield – Hardcoated</b>	Maverick X3, Maverick X3 MAX	<b>715004417</b>	<b>\$799.99</b>
-------------------------------------	------------------------------	------------------	-----------------



- High-impact-resistant Quantum hardcoated polycarbonate full windshield.
- Formed polycarbonate construction for enhanced rigidity.
- Provides excellent optical clarity and better abrasion resistance.
- Protects driver and passenger from the elements.
- Quick and easy tool-less installation or removal.
- Recommended to use with rear wind protection to maximize comfort for passenger.
- Can be used with the SMART Windshield Wiper and Washer Kit (715004762).

<b>Half Windshield</b>	Maverick X3, Maverick X3 MAX	<input type="checkbox"/> <b>715002909</b> • Clear	<b>\$369.99</b>
		<input type="checkbox"/> <b>715004291</b> • Tinted	<b>\$399.99</b>



- High-impact-resistant durable polycarbonate half windshield.
- Formed polycarbonate construction for enhanced rigidity.
- Formulated to be non-yellowing, non-crazing, non-cracking with excellent UV resistance and optical clarity.
- Protects driver and passenger from the elements.
- Features reverse angle lip to deflect air flow.
- Quick and easy tool-less installation or removal.

<b>SMART Windshield Wiper &amp; Washer Kit</b>	Maverick X3, Maverick X3 MAX Fit with Full Windshield Hardcoated (715004417)	<b>715004762</b>	<b>\$748.99</b>
	Maverick X3, Maverick X3 MAX Fit with Glass Windshield (715008859)	<b>715003282</b>	<b>\$719.99</b>



- An ideal way to keep your windshield clear in rain, or while riding through mud and water.
- Includes single-speed wiper and washer fluid dispenser.
- Wiper mechanism and washer fluid dispenser perfectly concealed within the vehicle.
- Smart and fixed intermittence wiper speed feature available when the kit is installed in combination with ACM.

<b>Manual Wiper Kit</b>	Maverick X3, Maverick X3 MAX	<b>715009424</b>	<b>\$127.99</b>
-------------------------	------------------------------	------------------	-----------------



- Single manual wiper that can be used to clear windshield of debris.
- Easy to install system that requires no electrical hookup.
- Large ergonomic handle provides a good grip over the entire sweeping surface.
- Compatible with glass and hardcoated windshields that use top mounted wipers.

## WIND PROTECTION

<b>Rear Wind Screen</b>	Maverick X3, Maverick X3 MAX (except X mr models)	<b>715006701</b>	<b>\$137.99</b>
-------------------------	---	------------------	-----------------





- Full rear mesh screen reduces windshield backdraft for added cabin comfort.
- Installs quickly and easily on roll cage.
- Large white Can-Am logo on black mesh.

<b>Rear Polycarbonate Window</b>	Maverick X3, Maverick X3 MAX (except X mr models)	<b>715006387</b>	<b>\$393.99</b>
	<ul style="list-style-type: none"> <li>• High-impact-resistant polycarbonate window.</li> <li>• Blocks windshield backdraft or dust and rain from entering for added cabin comfort.</li> <li>• Quick and easy tool-less installation.</li> <li>• Ready for MTX Audio System Rear Speakers.</li> </ul>		

<b>Soft Rear Window</b>	Maverick X3, Maverick X3 MAX (except X mr models)	<b>715006702</b>	<b>\$137.99</b>
	<ul style="list-style-type: none"> <li>• Clear, flexible window made from transparent vinyl.</li> <li>• Resists cold-cracking to -4°F (-20°C).</li> <li>• Ideal for preventing backdraft of dust or rain in harsh environments.</li> <li>• Quick tool-less installation.</li> </ul>		

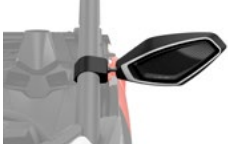
# MIRRORS

<b>Aluminum Side Mirrors</b>	Maverick X3, Maverick X3 MAX	<b>715007363</b>	<b>\$351.49</b>
	<ul style="list-style-type: none"> <li>• Sleek design.</li> <li>• High-quality black molded aluminum for extreme durability.</li> <li>• The convex surface provides a wider field of view and better visibility around the unit.</li> <li>• Can be installed at any height on the cage A-pillar for optimized rider vision.</li> <li>• Possibility to install the Integrated SMART LED Side Mirror Lights (715007185).</li> <li>• Adjustable ball-joint mirrors.</li> <li>• Possibility to fold down the mirrors (fold-away mechanism).</li> <li>• Not compatible with Glass Windshield and upper soft door panel.</li> <li>• Sold in pairs.</li> </ul>		

<b>Side Mirrors</b>	Maverick X3, Maverick X3 MAX	<b>715007188</b>	<b>\$212.99</b>
	<ul style="list-style-type: none"> <li>• Sleek design.</li> <li>• High-impact resistant plastic mirrors.</li> <li>• The convex surface provides a wider field of view and better visibility around the unit.</li> <li>• Can be installed at any height on the cage A-pillar for optimized rider vision.</li> <li>• Adjustable ball-joint mirrors.</li> <li>• Possibility to fold down the mirrors (fold-away mechanism).</li> <li>• Not compatible with Glass Windshield and upper soft door panel.</li> <li>• Sold in pairs.</li> </ul>		

<b>Side Mirrors</b>	Maverick X3, Maverick X3 MAX	<b>715004236</b> • For stock quarter doors <b>715005315</b> • For aluminum doors	<b>\$319.49</b>  <b>\$319.49</b>
	<ul style="list-style-type: none"> <li>• Rugged cast aluminum mount with black nylon cover.</li> <li>• Multi-position adjustable ball-joint mounted mirrors.</li> <li>• Convex optics for a wide viewing angle.</li> <li>• Spring-loaded pivots let mirrors fold back completely.</li> <li>• Door mounted.</li> <li>• Compatible with Upper Soft Door Panels.</li> <li>• Sold in pairs.</li> </ul>		

<b>Racing Side Mirrors</b>	Maverick X3, Maverick X3 MAX	<b>715002898</b>	<b>\$276.99</b>
	<ul style="list-style-type: none"> <li>• Race-inspired design features rugged black nylon % construction with coated cast-aluminum mount.</li> <li>• Dual adjustment provides optimal field of view (FOV).</li> <li>• Multi-position adjustable ball-joint mounted mirrors.</li> <li>• Flat optics deliver improved distance perception.</li> <li>• Spring-loaded pivots let mirrors fold back completely.</li> <li>• Not compatible with Lonestar Racing Light Racks, Upper Soft Door Panels or Flip Audio Roof Kit (715007131).</li> <li>• Sold in pairs.</li> </ul>		

<b>Rally Side Mirrors</b>	Maverick X3, Maverick X3 MAX	<b>715005262</b>	<b>\$212.99</b>
---------------------------	------------------------------	------------------	-----------------



- Sleek design with unique racing style.
- High-quality black molded aluminum for extreme durability.
- 4" (10 cm) convex surface provides a wider field of view and better visibility around the unit.
- Can be installed at any height on the cage A-pillar for optimized rider vision.
- Multi-position adjustable ball-joint-mounted mirrors.
- Spring-loaded pivots let mirrors fold back completely.
- Sold in pairs.
- Not compatible with Glass Windshield.

<b>Rear Mirror &amp; Camera Monitor</b>	Maverick X3, Maverick X3 MAX	<b>715009410</b>	<b>\$534.99</b>
---	------------------------------	------------------	-----------------



- Fully waterproof rearview mirror and monitor kit.
- See exactly what you need to see with the multiple camera feeds from the rear view camera.
- This unit replaces the stock rearview mirror (the screen is integrated in the unit's replacement rearview mirror).
- The camera uses infrared light for night vision capabilities.

# DOORS

<b>Aluminum Half Doors</b>	Maverick X3, Maverick X3 MAX	<b>715007971</b> • Front	<b>\$904.49</b>
	Maverick X3 MAX	<b>715007972</b> • Rear	<b>\$904.49</b>



- Lightweight half doors made of formed 5/64" (2 mm) thick aluminum.
- Smooth finish.
- Engineered for maximum rigidity and durability.
- Designed for a perfect fit and seamless integration with the vehicle's lines.
- Contoured with a thick seal for better protection from the elements.
- Easy installation using the standard door frame.
- Includes the easy-to-operate Deluxe Door Handles.
- Compatible with the Upper Soft Door Panels, the Window Nets and Upper Door Storage Bags.
- Not compatible with the Lower Door Panel Storage Bags.
- Sold in pairs.

<b>Deluxe Door Handles</b>	Maverick X3, Maverick X3 MAX	<b>715004758</b> • Front	<b>\$223.49</b>
	Maverick X3 MAX	<b>715004860</b> • Rear	<b>\$217.99</b>

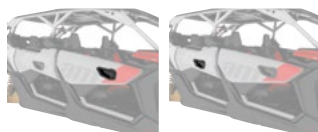

- Convert the standard door straps into easy-to-access door handles.
- Include inside and outside handles for each door.
- Greatly facilitate door opening.
- Standard on accessory Aluminum Half Doors.
- Sold in pairs.

<b>Lower Door Panels</b>	Maverick X3, Maverick X3 MAX	<b>715002903</b> • Front	<b>\$425.99</b>
		<b>715003751</b> • Rear	<b>\$425.99</b>

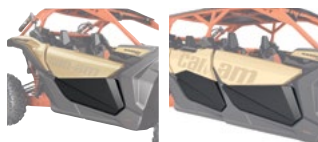

- Robust injection-molded polypropylene construction designed to match vehicle.
- Extend stock doors at bottom to protect from the elements.
- A great-looking add-on.
- Easy and quick installation.
- Sold in pairs.

<b>Window Nets</b>	Maverick X3	<b>715006693</b> • Front	<b>\$212.99</b>
	Maverick X3 MAX	<b>715004694</b> • Front	<b>\$212.99</b>
	Maverick X3 MAX	<b>715006700</b> • Rear	<b>\$212.99</b>



- Window mesh screen for added protection from wind.
- Can be easily lowered in seconds.
- Sold in pairs.
- Not compatible with Can-Am Audio Roof.

<b>Upper Soft Door Panels</b>	Maverick X3 (except X mr models)	<b>715008091</b> • 2 doors	<b>\$869.99</b>
	Maverick X3 MAX (except X mr models)	<b>715008092</b> • 4 doors	<b>\$1,659.99</b>



- Weather-resistant panels reinforced with aluminum frame offer good protection from the elements.
- Extend stock quarter doors at the top.
- Made of heavy-duty UV-resistant solution-dyed polyester canvas for excellent resistance to tear and abrasion.
- Zip-down windows made of laminated polished vinyl material for added ventilation.
- To be combined with the Lower Door Panels to obtain complete door kits for your vehicle.
- Not compatible with Racing Side Mirrors, Side Mirrors, Aluminum Side Mirror and Can-Am Audio Roof.

# SEAT ACCESSORIES

<b>4-Point Harness</b>	Maverick X3, Maverick X3 MAX	<b>715008033</b> • Driver	<b>\$283.49</b>
		<b>715008034</b> • Passenger	<b>\$235.49</b>



- Exclusive controlled decelerator technology (patent pending) absorbs additional energy in case of accident.
- Designed to offer maximum riding comfort.
- Easy one-click latch and release.
- Patent pending.
- Not EC compliant.

<b>Retractable 4-Point Harness</b>	Maverick X3, Maverick X3 MAX	<b>715005021</b> • Driver	<b>\$329.49</b>
		<b>715005022</b> • Passenger	<b>\$308.99</b>



- Convenient harness allows you to move freely in your seat and at the same time fully benefit from the extra support given by the 4-point attachments.
- Makes it easier to buckle up and requires fewer adjustments when switching passenger or driver.
- Retractor Protector (707900653) is required for installation on front seats of MAX models.
- Compatible with rear passengers' seats on MAX models.
- Standard on select Maverick X3 models.

<b>Retractor Protector</b> <i>(Not illustrated)</i>	Maverick X3 MAX	<b>707900653</b>	<b>\$129.99</b>
--	-----------------	------------------	-----------------

- Protective pad required for the installation of the Retractable 4-Point Harness on front seat of MAX models.
- Protects the passengers from the retractor mechanism.
- Sold individually.

<b>Seat Belt Shoulder Pads</b>	Maverick X3, Maverick X3 MAX	<b>715002894</b>	<b>\$48.99</b>
--------------------------------	------------------------------	------------------	----------------



- Provide additional riding comfort by preventing seat belt from rubbing on neck and shoulder.
- Fit with stock 3-point seat belts and 4 point harness.
- Easy Velcro installation.
- Can-Am branded.
- Sold in pairs for driver and passenger.

# HMWPE SKID PLATES

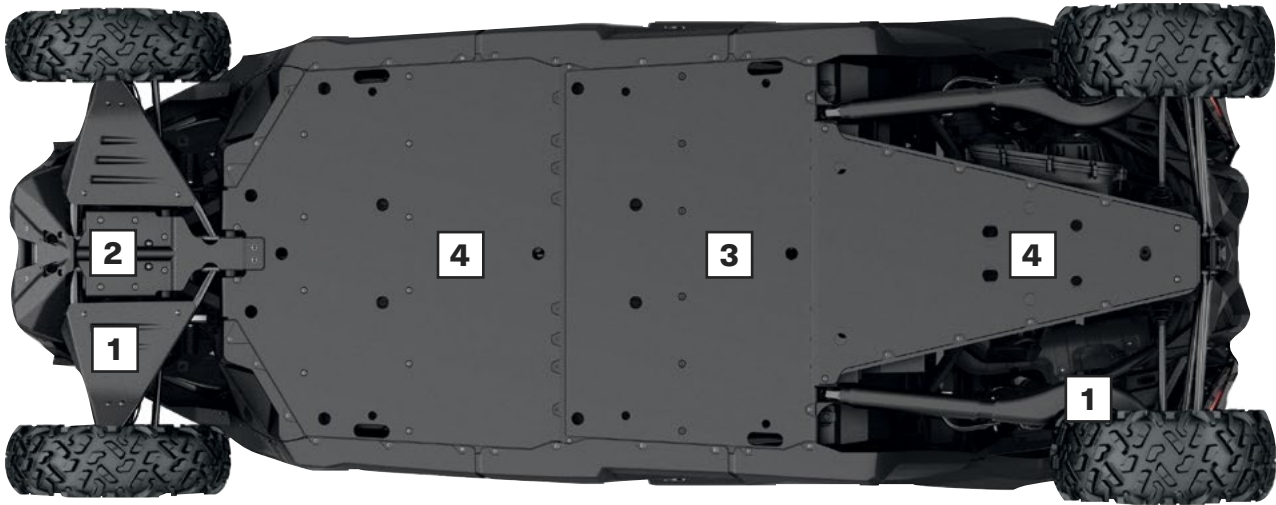

Our plastic plates glide smoothly and silently over obstacles, offering great protection in rough terrain. Made of abrasion-resistant thermoformed  $\frac{3}{8}$ " (10 mm) thick High Molecular Weight Polyethylene (HMWPE).

- Lighter than aluminum.
- Superior stress crack resistance.
- High-impact strength.

## MAVERICK X3, MAVERICK X3 MAX

HMWPE Skid Plates are standard on X rs models (2019 to 2021) and X rc models (2022 & up) only.

Maverick X3  
64" models

Maverick X3 Max  
64" models

Maverick X3,  
Maverick X3 Max  
72" models  
(except Base models)

Maverick X3  
Base 72" models

Maverick X3 Max  
Base 72" models

### HMWPE SKID PLATE PROTECTION KIT

715003713

715003747

715003718

715006767







715006769

### INDIVIDUAL HMWPE SKID PLATES

	Maverick X3 64" models	Maverick X3 Max 64" models	Maverick X3, Maverick X3 Max 72" models (except Base models)	Maverick X3 Base 72" models	Maverick X3 Max Base 72" models
<b>1</b> HMWPE Front A-Arm and Trailing Arm Protectors	715002905	715002905	715003552	715003552	715003552
<b>2</b> HMWPE Front Skid Plate	715003933	715003933	715003933	715003933	715003933
<b>3</b> HMWPE Central Skid Plate	—	715003731	Standard on X rc models only	—	715003731
<b>4</b> HMWPE Underbelly Plate	715004904	715004904	Standard on X rc models only	715004904	715004904

# BUMPERS & GUARDS

## BUMPERS

<b>Front Pre-Runner Bumper</b>	Maverick X3, Maverick X3 MAX	■ <b>715002878</b> • Black ■ <b>715003433</b> • Can-Am Red	<b>\$478.99</b>
	<ul style="list-style-type: none"> <li>• Made of 1.5" (3.8 cm) diameter steel tubing with a 1/8" (3 mm) aluminum plate for extra durability.</li> <li>• Inside and outside anti-corrosion coating with durable powder coat finish.</li> <li>• Added heavy-duty protection in extreme driving conditions.</li> <li>• Integrated winch mounting plate and mount points for lights.</li> </ul>		
<b>Rear Pre-Runner Bumper</b>	Maverick X3, Maverick X3 MAX	■ <b>715002880</b> • Black ■ <b>715003436</b> • Can-Am Red	<b>\$478.99</b>
	<ul style="list-style-type: none"> <li>• Extra-durable 1.5" (3.8 cm) diameter steel tubing with a 1/8" (3 mm) aluminum plate.</li> <li>• Inside and outside anti-corrosion coating with durable powder coat finish.</li> <li>• Protects vehicle bodywork and exhaust system.</li> <li>• Rear Receiver Hitch compatible.</li> <li>• Required for installation of the Rear Cage Extension.</li> </ul>		
<b>Dune Front Bumper</b>	Maverick X3, Maverick X3 MAX	■ <b>715002961</b> • Black ■ <b>715003432</b> • Can-Am Red	<b>\$383.49</b>
	<ul style="list-style-type: none"> <li>• Made of 1.5" (3.8 cm) diameter aluminum tubing with a 1/8" (3 mm) aluminum plate.</li> <li>• Inside and outside anti-corrosion coating with durable powder coat finish.</li> <li>• Provides added protection without sacrificing the agility and performance advantages of a lighter weight design.</li> <li>• Features a more pronounced attack angle and integrated mounting points for lights.</li> <li>• Not winch compatible.</li> </ul>		
<b>Dune Rear Bumper</b>	Maverick X3, Maverick X3 MAX 2021 & prior Maverick X3, Maverick X3 MAX 2022 & up	■ <b>715002962</b> • Black ■ <b>715003437</b> • Can-Am Red ■ <b>715009242</b> • Black	<b>\$383.49</b>
	<ul style="list-style-type: none"> <li>• Made of 1.5" (3.8 cm) diameter aluminum tubing with a 1/8" (3 mm) aluminum plate.</li> <li>• Inside and outside anti-corrosion coating with durable powder coat finish.</li> <li>• Provides added protection without sacrificing the agility and performance advantages of a lighter weight design.</li> <li>• Protects vehicle bodywork and exhaust system.</li> <li>• Rear hitch compatible.</li> <li>• Not compatible with Rear Cage Extension and Lonestar Racing Spare Tire Holder.</li> </ul>		
<b>X rc/X mr Front Bumper</b>	Maverick X3, Maverick X3 MAX	■ <b>715004788</b> • Black	<b>\$510.99</b>
	<ul style="list-style-type: none"> <li>• Made of 1.5" (3.8 cm) diameter steel tubing with a 1/8" (3 mm) aluminum plate.</li> <li>• Inside and outside anti-corrosion coating with durable powder coat finish on steel tubing.</li> <li>• Offers all the essential features required for technical driving: low front-end protection, support base for winch installation and integrated tow hook.</li> <li>• Standard on Maverick X3 X rc and X mr models.</li> <li>• Not compatible with winches with steel cable.</li> </ul>		
<b>Lonestar Racing Front Bumper</b>	Maverick X3, Maverick X3 MAX (not compatible X mr and X rc models)	■ <b>715005510</b> • Hyper Silver ■ <b>715005509</b> • Black	<b>\$489.99</b>
	<ul style="list-style-type: none"> <li>• Made of 1.5" (3.8 cm) diameter steel tubing with durable powder coat finish and a 1/8" (3 mm) thick aluminum plate for added vehicle-front protection in extreme driving conditions.</li> <li>• Sleek styling enhances the vehicle's race-inspired look.</li> <li>• Not winch compatible.</li> <li>• Not compatible with 10" (25 cm) Baja Designs OnX6 LED Light Bar and SMART 10" (25 cm) LED Light Bar (715008745).</li> <li>• Not compatible with stock Smart-Shox.</li> </ul>		

<b>Lonestar Racing Rear Bumper</b>	Maverick X3, Maverick X3 MAX 2021 & prior	■ <b>715005512</b> • Hyper Silver ■ <b>715005511</b> • Black ■ <b>715004162</b> • Can-Am Red	<b>\$529.99</b>



- Made of 1.5" (3.8 cm) diameter steel tubing with durable powder coat finish.
- Provides additional vehicle-rear bodywork and exhaust system protection in extreme driving conditions.
- Sleek styling enhances the vehicle's race-inspired look.
- Compatible with Lonestar Racing Spare Tire Holder.
- Not hitch compatible.

<b>S3† Front Bumper</b>	Maverick X3, Maverick X3 MAX	■ <b>715004867</b> • Black	<b>\$563.99</b>
-------------------------	------------------------------	----------------------------	-----------------



- Made of 1.5" (3.8 cm) diameter steel tubing with a 1/8" (3 mm) aluminum plate for extra durability.
- Inside and outside anti-corrosion coating with durable powder coat finish.
- Added heavy-duty protection in extreme driving conditions.
- Integrated winch support plate and mount points for lights.
- Hook support anchor allows you to keep the winch hook within easy reach when riding in deep mud.
- "S3 for Can-Am" branded.
- Winch not included.

<b>S3 Rear Bumper</b>	Maverick X3, Maverick X3 MAX 2021 & prior	■ <b>715004869</b> • Black	<b>\$766.49</b>
-----------------------	---	----------------------------	-----------------



- Made of extra-durable 1.5" (3.8 cm) diameter steel tubing.
- Inside and outside anti-corrosion coating with durable powder coat finish.
- Added heavy-duty protection in extreme driving conditions—protects vehicle bodywork and exhaust system.
- Permits installation of a winch at a higher location to improve accessibility in muddy conditions.
- "S3 for Can-Am" branded.
- Engineered to sustain heavy winch loads without damaging the vehicle's frame.
- Compatible with Can-Am HD and WARN VRX winches—Rear Winch Harness (715006007) is required to install a winch on the bumper.
- Includes a robust recovery hook to facilitate vehicle recovery.
- Winch not included.
- Not EC compliant.

## ROCK SLIDERS

<b>Rock Sliders</b>	Maverick X3 (except X rc)	■ <b>715002963</b> • Black ■ <b>715003438</b> • Can-Am Red	<b>\$350.99</b> <b>\$393.99</b>
	Maverick X3 MAX	■ <b>715003730</b> • Black ■ <b>715003888</b> • Can-Am Red	<b>\$479.49</b> <b>\$542.99</b>



- Made of heavy-duty 1.5" (3.8 cm) diameter steel tubing.
- Inside and outside anti-corrosion coating with durable powder coat finish.
- Protect vehicle's sides and undercarriage against large obstacles.
- Support plate adds rigidity and style.
- Sold in pairs.

<b>Lonestar Racing Rock Sliders</b>	Maverick X3 (except X rc models)	■ <b>715005514</b> • Hyper Silver ■ <b>715008845</b> • Black ■ <b>715008846</b> • Can-Am Red	<b>\$419.99</b>
	Maverick X3 MAX	■ <b>715008847</b> • Black ■ <b>715008848</b> • Can-Am Red	<b>\$829.99</b>



- Race-engineered to Lonestar Racing's trademark standards for toughness, these stylishly crafted accessories will also enhance your vehicle with visual impact.
- Made of 1.5" (3.8 cm) diameter steel tubing with durable powder coat finish.
- Essential protection from large obstacles for your vehicle's sides.
- Sold in pairs.
- Maverick X3 MAX: Not compatible with the Rear Aluminum Half Doors (715007972).

## INTRUSION BARS

### Front Intrusion Bar

Maverick X3, Maverick X3 MAX

■ **715002889** - Black  
■ **715003435** - Can-Am Red

**\$436.49**



- Matches vehicle styling.
- Inside and outside anti-corrosion coating with durable powder coat finish steel intrusion bar.
- Tube design reduces obstructed lines of sight and blind spots for better visibility.
- Not compatible with windshields or Lonestar Racing Aluminum Roof.

### Lonestar Racing Front Intrusion Bar

Maverick X3, Maverick X3 MAX

■ **715003916** - Black

**\$479.99**



- Made of 1.5" (3.8 cm) diameter steel tubing with durable powder coat finish.
- Enhances the racing look of the vehicle.
- Compatible with Lonestar Racing Aluminum Roof and Aluminum Roofs.
- Not compatible with windshields.

### Lonestar Racing Rear Intrusion Bar

Maverick X3 (except X mr models),  
Maverick X3 MAX

■ **715003918** - Black

**\$379.99**



- Made of 1.5" (3.8 cm) diameter steel tubing with durable powder coat finish.
- Sleek styling enhances the vehicle's race-inspired look.
- Required for the installation of the Lonestar Racing Spare Tire Holder.
- Not compatible with LinQ mounted accessories or Pre-Filter in the cargo bed.

## OTHER ACCESSORIES

### Fender Flares

Maverick X3, Maverick X3 MAX

**715002973**

**\$259.99**



- Extended fender flares made from injection-molded polypropylene.
- Keep mud and debris out of vehicle.
- Designed for quick and easy installation.
- Include front and rear extensions and mounting hardware.

### Lonestar Racing Spare Tire Holder

Maverick X3, Maverick X3 MAX 2021 & prior  
(except X mr models)

■ **715003922** - Black

**\$274.99**



- Made of 1.5" (3.8 cm) diameter steel tubing with durable powder coat finish.
- Adjustable height to fit Can-Am tires up to 30 in.
- Requires Lonestar Racing Rear Bumper and Lonestar Racing Rear Intrusion Bar for installation.
- Cannot hold the Pro Armor Quickshot Wheel Jack and Off-Road Screw Jack.
- Wheel not included.
- Not compatible with the S&B Particle Separator or LinQ accessories intended for the rear of the vehicle.

### Lonestar Racing Number Plate Holder

Maverick X3, Maverick X3 MAX

**715003943**

**\$224.99**



- Includes a pair of sturdy aluminum number plates that mount on either side of the vehicle rear.
- Not compatible with LinQ Pivoting Rack.
- Numbered decals are available through SCS Unlimited.
- Styling enhances the vehicle's race-inspired look while adding a personal touch.
- Black background.

### S3 Rear Pull Plate

Maverick X3, Maverick X3 MAX 2021 & prior

■ **715004870** - Black  
■ **715005233** - Can-Am Red

**\$159.49**



- Offers a solid place to hook onto in case towing is needed.
- Allows you to attach most straps and hooks.
- "S3 for Can-Am" branded.

# LINQ: EASY ON, EASY OFF CARGO

## MAVERICK'S LINQ ACCESSORIES

### MOUNTING LOCATION AND REQUIREMENTS

<ul style="list-style-type: none"> <li>• No tools needed: Quickly install and remove accessories by hand</li> <li>• Equip your Can-Am for specialized tasks in no time</li> <li>• Sturdy mounting system that holds up to the roughest terrain</li> </ul>	Standard Cargo Bed	LinQ Pivoting Rack 715010786/715008296	Adventure Roof Rack 715003868/715006225
<b>LinQ ACCESSORIES WITH 16" BASE</b> <ul style="list-style-type: none"> <li>• LinQ anchors mounted 16 inches apart, center-to-center.</li> <li>• Lower loading capacity than the LinQ with 36" base accessories.</li> <li>• Can be used on Can-Am ATV and SxS vehicles, Can-Am Spyder and Ryker vehicles, Sea-Doo watercraft and Ski-Doo snowmobiles.</li> </ul>			
<b>NEW LinQ Rigid Cooler 4.7 US Gal (18 L)</b> 715010491	LinQ Anchor Adapter Kit 715004960	LinQ Anchor Adapter Kit 715004960	LinQ Base Installation Kit 715008125
<b>NEW LinQ Cooler 5.3 US Gal (20 L)</b> 295101257 • Gray			
<b>LinQ 4.2 Gal Cooler</b> 295100698 • White 219400964 • Black			
<b>LinQ Tool Kit</b> 715006829			
<b>LinQ Tool Box</b> 715008111			
<b>LinQ SR 5.5 Gal (21 L) Bag</b> 860202449			
<b>LinQ 4.5 Gal (17 L) Sport Bag</b> 860202447			
<b>LinQ Modular Box</b> 715005494 • (10 L) 715007112 • (20 L) 715006830 • (30 L)			
<b>LinQ Roll-Top Bag</b> 715008110			
<b>LinQ 5.3 US Gal (20 L) Semi-Rigid Cooler</b> 295101252			
<b>LinQ ACCESSORIES WITH 36" BASE</b> <ul style="list-style-type: none"> <li>• Mount on LinQ racks often used by Can-Am ORV vehicles.</li> <li>• Higher loading capacity than the LinQ with 16" base accessories.</li> <li>• Usage is limited to Can-Am ORV vehicles.</li> </ul>			
<b>LinQ 12 Gal (45 L) Cargo Box</b> 715003879	No further requirements	No further requirements	No compatibility
<b>LinQ 23 Gal (86 L) Trunk Box</b> 715004923	No further requirements		
<b>LinQ 32 Gal (121 L) Trunk Box</b> 715001748	*Not compatible if the LinQ Pivoting Rack is installed.		
<b>LinQ 11.5 Gal (43 L) Audio Cargo Box</b> 715003018	No further requirements		
<b>LinQ 8 Gal (30 L) Cooler Box</b> 715004778 • Black			
<b>LinQ Premium Storage Bag by OGIO†</b> 715002923 • Black			
<b>LinQ Heavy Duty Basket</b> 715001215			
<b>LinQ Low Profile Basket</b> 715004282			
<b>LinQ HOLDERS</b>			
<b>LinQ Gear Grips</b> 715005340	No further requirements	No further requirements	Side wall installation LinQ Adapters 715003058
<b>LinQ Tool Holder</b> 715007358			

The LinQ system is BRP's game-changing, tool-free cargo solution. Snap gear on or off in seconds. No fuss, no rattle, just rock-solid mounting on any terrain.

# LINQ SYSTEM ADVANTAGE

## ORIGINAL LinQ SYSTEM

Handles medium- to large-sized gear with two anchor setups: the 16" base for standard accessories and the 36" base for racks and serious payloads.

## LinQ LITE

Made for smaller items, lightweight gear you can hang from rails or vertical mounts.



### LinQ ACCESSORIES WITH 16" BASE

<b>NEW LinQ Rigid Cooler 4.7 US Gal (18 L)</b>	Maverick X3, Maverick X3 MAX	<b>715010491</b>	<b>\$394.04</b>
	<ul style="list-style-type: none"> <li>• Versatile LinQ 16" configuration fits many vehicles.</li> <li>• Durable rotomolded rigid construction.</li> <li>• Molded-in handles for quick installation and removal.</li> <li>• High quality insulation for optimal ice retention.</li> <li>• Sealed lid for airtight, weather-tight closure.</li> </ul>	<ul style="list-style-type: none"> <li>• Ergonomic and secure latch system offers excellent sealing.</li> <li>• 4.7 US gal (18 L) capacity.</li> <li>• Not compatible below the LinQ Pivoting Rack (715010786 or 715008296).</li> <li>• See table for installation location and requirements.</li> </ul>	

<b>NEW LinQ Cooler 5.3 US Gal (20 L)</b>	Maverick X3, Maverick X3 MAX	<b>295101257</b>	<b>\$409.99</b>
	<ul style="list-style-type: none"> <li>• LinQ-mounted for fast, easy and secure storage.</li> <li>• Locks in place with just a quarter turn.</li> <li>• High-quality insulation for optimal ice retention.</li> <li>• Keeps ice cold for 5 days.</li> <li>• Rotomolded construction for exceptional rigidity and durability.</li> <li>• Sealed lid for airtight, weather-tight closure.</li> <li>• Rigid handles make transportation easy.</li> <li>• Horizontal locking handles allow for installation of LinQ Lite accessories.</li> </ul>	<ul style="list-style-type: none"> <li>• Holds thirty-four 355 ml cans.</li> <li>• 5.3 US gal (20 L) capacity.</li> <li>• Exterior dimensions: 21" L x 15" W x 14" H (52 cm L x 38 cm W x 35 cm H),</li> <li>• Interior dimensions: 15" L x 10" W x 9" H (39 cm L x 26 cm W x 23 cm H),</li> <li>• LinQ Base Installation Kit (715008125) is required for installation.</li> <li>• Not compatible below the LinQ Pivoting Rack (715010786 or 715008296).</li> </ul>	

*Note: Cannot be mounted on the LinQ Stackable Fuel Caddy.*

<b>LinQ Modular Box</b>	Maverick X3, Maverick X3 MAX	<b>715005494</b> • (10 L)	<b>\$148.99</b>
		<b>715007112</b> • (20 L)	<b>\$170.49</b>
		<b>715006830</b> • (30 L)	<b>\$191.49</b>



- Allows stacking of other modular boxes to always have the right gear accessible.
- Always have the right box size to fit everything.
- Can be installed on any LinQ base with a 16" width.
- See table for installation location and requirements.

<b>Thermal Insert for LinQ Modular Box (10 L)</b>	Maverick X3, Maverick X3 MAX	<b>219401110</b>	<b>\$63.99</b>
---	------------------------------	------------------	----------------



- Insulated liner.
- Fits very well in the LinQ Modular Box (10 L).
- Can contain seven 355 ml cans.
- Keeps ice cold for one day.
- Interior dimensions: 9" L x 17" W x 2½" H.

<b>LinQ Tool Box</b>	Maverick X3, Maverick X3 MAX	<b>715008111</b>	<b>\$191.49</b>
----------------------	------------------------------	------------------	-----------------



- High precision injected HDPE construction provides rigidity and durability.
- 5 gal (19 L) maximum capacity.
- Weather-resistant, sealed and lockable cover.
- Easy one-second on/off tool-less system.
- All the benefits of LinQ—simple, fast and secure.
- See table for installation location and requirements.

<b>LinQ Tool Kit</b>	Maverick X3, Maverick X3 MAX	<b>715006829</b>	<b>\$352.99</b>
----------------------	------------------------------	------------------	-----------------



- Includes:
- Cutter pliers
  - Long-nose pliers
  - Locking pliers
  - Ratchet wrench ¾" drive
  - 6" ratchet extension
  - Integrated CVT belt storage location (belt not included)
  - Long-socket 19 mm ¾" drive – 6 pts
  - Socket 18 mm ¾" drive
  - Long-socket 17 mm ¾" drive – 6 pts
  - Socket 15 mm ¾" drive
  - Socket 13 mm ¾" drive
  - Socket 10 mm ¾" drive
  - Socket 8 mm ¾" drive
  - Socket Torx T40 ¾" drive
  - Socket Torx T30 ¾" drive
  - Socket Torx T20 ¾" drive
  - Breaker bar ¾" drive
  - Combination Wrench set:
    - Wrench 19 mm
    - Wrench 18 mm
    - Wrench 15 mm
  - Wrench 13 mm
  - Wrench 10 mm
  - Wrench 8 mm
- See table for installation location and requirements.

<b>LinQ 4.2 Gal (16 L) Cooler</b>	Maverick X3, Maverick X3 MAX	■ <b>219400964</b> • Black	<b>\$379.99</b>
		■ <b>295100698</b> • White	<b>\$379.99</b>



- All the benefits of LinQ—simple, fast and secure.
- Rotomolded construction for exceptional rigidity and durability.
- Premium-quality foam insulation for optimal ice retention.
- Uses LinQ mounting system (Patent US 8777531 and US 8875830).
- Easy one-second on/off tool-less system.
- Can contain twenty 355 ml cans.
- Keeps ice cold for three days.
- Exterior dimensions: 13" L x 20" W x 10" H.
- Interior dimensions: 9" L x 17" W x 7" H.
- See table for installation location and requirements.

<b>NEW LinQ 5.3 US Gal (20 L) Semi-Rigid Cooler</b>	Maverick X3, Maverick X3 MAX	<b>295101252</b>	<b>\$265.99</b>
---	------------------------------	------------------	-----------------



- 5.3 US gal (20 L) of insulated, water-resistant capacity.
- Quick, easy and secure LinQ system installation.
- Attaches with one set of LinQ fasteners.
- Single-day-use soft cooler.
- Mesh pocket on top of the lid.
- Zippered pocket under the lid for quick and easy access.
- Removable interior for easy cleaning.
- Carry handles for easy transport.
- Can contain twelve 355 ml cans.
- Dimensions: 19" L x 13" W x 10" H.
- See table for installation location and requirements.

<b>LinQ 4.5 Gal (17 L) Sport Bag</b>	Maverick X3, Maverick X3 MAX	<b>860202447</b>	<b>\$223.49</b>
--------------------------------------	------------------------------	------------------	-----------------



- All the benefits of LinQ—simple, fast and secure.
- 17 liter (4.5 US gallon) capacity.
- Thermoformed bag base in HDPE (High Density Polyethylene) providing rigidity and durability.
- Rigid bottom, semi-rigid top.
- Easy one-second on/off tool-less system.
- See table for installation location and requirements.

<b>SR 5.5 Gal (21 L) LinQ Bag</b>	Maverick X3, Maverick X3 MAX	<b>860202449</b>	<b>\$244.99</b>
-----------------------------------	------------------------------	------------------	-----------------



- All the benefits of LinQ—simple, fast and secure.
- Semi-rigid expandable bag.
- 5.5 gal (21 L) capacity.
- Utilizes LinQ mounting system (Patent US 8777531 and US 8875830).
- Easy one-second on/off tool-less system.
- See table for installation location and requirements.

<b>LinQ Roll-Top Bag</b>	Maverick X3, Maverick X3 MAX	<b>715008110</b>	<b>\$244.99</b>
--------------------------	------------------------------	------------------	-----------------



- Fully waterproof roll-top dry bag will securely store and confine your equipment.
- LinQ mounted using heavy-duty rigid plastic base.
- High capacity storage solution (40 L).
- Bottom foam liner for additional equipment protection.
- Integrated handle for easy transportation on/off the vehicle.
- Dimensions: 14" L x 19" W x adjustable H.
- See table for installation location and requirements.

## LinQ ACCESSORIES WITH 36" BASE

<b>LinQ 12 Gal (45 L) Cargo Box</b>	Maverick X3, Maverick X3 MAX	<b>715003879</b>	<b>\$329.99</b>
-------------------------------------	------------------------------	------------------	-----------------



- LinQ mounted for easy-on, easy-off installation.
- Holds cargo safely and securely while riding.
- See table for installation location and requirements.

<b>LinQ 23 Gal (86 L) Trunk Box</b>	Maverick X3 (except X mr models), Maverick X3 MAX	<b>715004923</b>	<b>\$393.99</b>
-------------------------------------	--	------------------	-----------------



- LinQ mounted for easy-on, easy-off installation.
- Holds cargo safely and securely while riding.
- See table for installation location and requirements.

<b>LinQ 32 Gal (121 L) Trunk Box</b>	Maverick X3 (except X mr models), Maverick X3 MAX	<b>715001748</b> • (No rear tail light)	<b>\$524.49</b>
--------------------------------------	--	---	-----------------



- Equipped with the LinQ system, the rear trunk box plugs in and out in seconds.
- 32 gal (121 L) load capacity with unobstructed space to maximize storage room and access to the trunk's interior.
- Made of injection-molded polyethylene, double walled in critical areas.
- The fully sealed lid protects your belongings from dust, moisture and the elements.
- No rear tail light.
- Trunk Box Panels available in many colors to match your vehicle (sold separately).
- See table for installation location and requirements.

<b>LinQ 32 Gal (121 L) Trunk Box Panels</b>	Fit with LinQ 32 Gal (121 L) Trunk Box EUROPEAN VERSION (EC compliant)		<b>\$63.99</b>
---	---	--	----------------

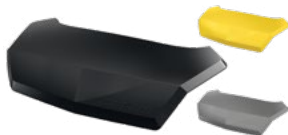

- Color panels to match the LinQ 32 gal (121 L) Trunk Box to your vehicle.
- No rear tail light

- **715001397** • Black
- **715001398** • Yellow
- **715002483** • White

- **715006121** • Can-Am Red
- **715006123** • Orange Crush
- **715006124** • Viper Red

<b>LinQ 8 Gal (30 L) Cooler Box</b>	Maverick X3, Maverick X3 MAX	■ <b>715004778</b> • Black	<b>\$469.99</b>
-------------------------------------	------------------------------	----------------------------	-----------------



- LinQ mounted for easy-on, easy-off installation.
- Rotomolded construction provides exceptional rigidity and durability.
- Premium-quality foam insulation for optimal ice retention.
- Integrated, fully removable compartment protects food.
- Robust rubber latches keep the cover tightly closed.
- Weather-resistant.
- Convenient drain plug.
- See table for installation location and requirements.

<b>LinQ 11.5 Gal (43 L) Audio Cargo Box</b>	Maverick X3, Maverick X3 MAX	<b>715003018</b>	<b>\$829.99</b>
---	------------------------------	------------------	-----------------



- An affordable and quick solution for adding music and storage to your next ride.
- The rear installation does not use up any cab space and allows easy listening at an average speed.
- Mounts on/off easily to hold/carry cargo safely and securely.
- Backlit control panel perfect for night riding.
- Water-resistant speakers.
- The Bluetooth<sup>1</sup> enabled receiver and 6.5" (16.5 cm) speakers are smartly concealed and integrated in the cover.
- Automatic shut-off function protects your battery by turning the system off after 10 minutes of inactivity.
- See table for installation location and requirements.

<b>LinQ Heavy-Duty Basket</b>	Maverick X3, Maverick X3 MAX	<b>715001215</b>	<b>\$297.99</b>
-------------------------------	------------------------------	------------------	-----------------



- Made of high-strength, low-alloy steel.
- LinQ mount for easy-on, easy-off installation.
- See table for installation location and requirements.

<b>LinQ Premium Storage Bag by OGIO</b>	Maverick X3, Maverick X3 MAX	■ <b>715002923</b> • Black	<b>\$532.49</b>
---	------------------------------	----------------------------	-----------------



- Tool-less installation and removal thanks to the LinQ system.
- 17.2 gal (65 L) capacity semi-rigid cargo bag ideal for carrying anything you need on your vehicle.
- Buckle and elastic closure with a rubber seal that prevents dust from entering the bag.
- 3-section lid for partial or full access to your bag.
- Inside separators for optimal bag organization.
- See table for installation location and requirements.

<b>LinQ Low Profile Basket</b>	Maverick X3, Maverick X3 MAX	<b>715004282</b>	<b>\$223.49</b>
--------------------------------	------------------------------	------------------	-----------------



- Low profile, open basket increases cargo space.
- Perfect for easy access to tools, rope, winch and plow accessories.
- Multiple bungee cord and tie-down anchor points.
- Made of impact-resistant injected polypropylene.
- See table for installation location and requirements.

## LinQ HOLDERS

<b>NEW LinQ Lite Action Camera Holder</b>	Maverick X3, Maverick X3 MAX 2026	<b>295101139</b>	<b>\$51.99</b>
---	-----------------------------------	------------------	----------------



- LinQ Lite attachment system for cameras.
- Provides great vantage points to capture photos and videos.
- Offers 360-angle positioning for perfect filming and taking photos.
- Designed to hold devices securely.
- Fast, easy attachment and removal.

<b>NEW LinQ Lite Device Holder</b>	Maverick X3, Maverick X3 MAX 2026	<b>715009201</b>	<b>\$191.69</b>
------------------------------------	-----------------------------------	------------------	-----------------



- Made with strong magnets that you can trust while riding through rough terrain
- Includes everything needed for installation on your favorite electronic devices: 2 pre-assembled Can-Am plates with 3M multi-surface adhesive.
- 360° adjustment for an improved driving experience and immersion.
- Secure LinQ Lite attachment allows you to install/remove the holder in seconds.
- Robust plastic and aluminum construction allows for the right fit and easy installation.
- Compatible with the Cellphone Holder (715008786).
- To keep a good vision while driving, we recommend using this device for smartphones only.

<b>LinQ Tool Holder</b>	Maverick X3, Maverick X3 MAX	<b>715007358</b>	<b>\$63.99</b>
-------------------------	------------------------------	------------------	----------------



- Ultra-versatile tool holder.
- Convenient swivel-latch allows tools to be stored in any orientation.
- Sold in pairs.

<b>LinQ Gear Grips</b>	Maverick X3, Maverick X3 MAX	<b>715005340</b>	<b>\$160.49</b>
------------------------	------------------------------	------------------	-----------------



- Durable and flexible grips provide a custom fit for a variety of items from 1" to 4" (2.5 cm to 10 cm) in diameter.
- Heavy-duty design for carrying bows, fishing poles, rakes, farm tools and more.
- Quick-release button opens grip quickly for easy access to gear.
- Heavy-duty base system built for the toughest adventures.
- Make transporting your tools a snap by combining the LinQ Gear Grips with the LinQ system.
- 360° orientation.
- Sold in pairs.

## LinQ MOUNTING

<b>LinQ Anchor Adapter Kit</b>	Maverick X3, Maverick X3 MAX	<b>715004960</b>	<b>\$84.99</b>
--------------------------------	------------------------------	------------------	----------------



- Allows the installation of LinQ accessories with 16" base on LinQ racks.
- Tool-less installation and removal.

<b>LinQ Base Installation Kit</b>	Maverick X3, Maverick X3 MAX	<b>715008125</b>	<b>\$31.99</b>
-----------------------------------	------------------------------	------------------	----------------



- Allows installation of compatible LinQ accessories.
- Included: 2 LinQ Cargo bases and hardware.

<b>LinQ Lock</b>	Maverick X3, Maverick X3 MAX	<b>860201968</b>	<b>\$66.99</b>
------------------	------------------------------	------------------	----------------



- Simple way to securely lock most LinQ accessories.
- Lock cover protects lock from the elements.
- Corrosion resistant.
- Pack of 1, includes 2 keys.
- Not compatible with LinQ 4.2 US Gal (16 L) Cooler, LinQ Tool Box, LinQ Tool Holder or LinQ Gear Grips.

<b>LinQ Replacement Part</b>	Maverick X3, Maverick X3 MAX	<b>715010798</b>	<b>\$42.49</b>
------------------------------	------------------------------	------------------	----------------



- Unique mounting fastener usable on any LinQ system accessory.
- Tool-less installation and removal.
- Sold in pairs.

<b>LinQ Adapter</b>	Maverick X3 MAX	<b>715003058</b>	<b>\$36.99</b>
---------------------	-----------------	------------------	----------------



- Allows the installation of the LinQ Tool Holder on the Adventure Roof Rack.
- Sold in pack of 4.

<b>Cargo Box Net</b>	Maverick X3, Maverick X3 MAX	<b>715001371</b>	<b>\$76.49</b>
----------------------	------------------------------	------------------	----------------



- Solid net designed to secure and ensure the compact confinement of your Adventure Roof Rack.

<b>Spare Tire Ratchet Tie-Downs</b>	Maverick X3, Maverick X3 MAX	<b>280000955</b>	<b>\$35.49</b>
-------------------------------------	------------------------------	------------------	----------------



- 3-way ratcheting tie-down strap with loop ends.
- Designed to securely hold spare tires on accessories equipped with integrated spare tire attachment points.
- Adjustable to accommodate most common UTV tire sizes.
- Ratchet and junction ring made of durable zinc-plated steel.
- Required for spare tire attachment on Adventure Roof Rack.

# RACKS & STORAGE

## RACKS

<b>LinQ Pivoting Rack</b>	Maverick X3, Maverick X3 MAX (except X mr models and X rc with Smart-Shox)	■ <b>715010786</b> • Black	<b>\$691.99</b>
		■ <b>715008296</b> • Can-Am Red	<b>\$694.99</b>



- LinQ latched rack allows for extra LinQ mounted accessories or for carrying a spare tire (tire not included).
- Includes custom tie-down strap for fast spare tire installation or removal (tire not included).
- Gas-cylinder pivot action, locks in the raised position.
- Trunk Boxes over 20 gal (74 L) do not fit on the vehicle when the rack is installed.
- Not compatible with Rear Intrusion Bars, Rear Cage Extension and Lonestar Racing Aluminum Roofs.
- Not compatible with snorkel and rad relocater.

<b>Adventure Roof Rack</b>	Maverick X3	<b>715006225</b>	<b>\$723.99</b>
	Maverick X3 MAX	<b>715003868</b>	<b>\$787.99</b>



- Ideal cargo solution for packing everything you need to live your Off-Road experience fully and completely.
- Built with lightweight 1.25" (3.2 cm) diameter steel tubing.
- Integrated mounting points for lights can hold up to eight pod-type LED lights (six front and two back) or a 40" (102 cm) LED bar (front).
- Features anchor points for spare-tire attachment.
- LinQ anchor on both sides.
- Spare Tire Tie-Downs sold separately.
- Add the Cargo Box Net to secure and confine your cargo in the rack.
- Loads up to 75 lb (34 kg).

<b>Adventure Roof Rack</b>	Maverick X3	<b>715007186</b>	<b>\$766.99</b>
----------------------------	-------------	------------------	-----------------



- The ideal cargo solution. Pack all the gear you need to take on any off-road experience.
- Built using lightweight 1.25" (3.2 cm) diameter steel tubing.
- Supports loads of up to 75 lb (34 kg).
- This roof rack features a height adjustment setting to precisely accommodate a stock roof.
- Integrated mounting points for lights.
- Features anchor points for a spare tire attachment.
- LinQ anchor on both sides.
- The Spare Tire Tie-Downs sold separately.
- Sport Roof or Aluminum Roof is required for installation.

## STORAGE

<b>Passenger Storage Seat Bag</b>	Maverick X3, Maverick X3 MAX	<b>715008080</b>	<b>\$265.99</b>
-----------------------------------	------------------------------	------------------	-----------------



- This weather-resistant bag holds your gear safely and securely while you ride.
- Bag settling on the passenger's seat to increase the vehicle's cargo capacity.
- This bag features a 14.5 gal (55 L) storage capacity and is divided into two compartments.
- The top compartment is insulated to keep your beverages cold and includes two cup holders.
- Additional pocket inside for additional storage, such as a cell phone.
- The bottom compartment is accessible from both sides and serves as a large pocket for storing various items.
- The detachable pocket at the front of the bag can be used as a garbage bag.

<b>Shoulder Storage Bag</b>	Maverick X3 (except X mr models), Maverick X3 MAX (rear only)	<b>715004277</b>	<b>\$132.99</b>
-----------------------------	--	------------------	-----------------



- Bag attaches in unused space between the seats to increase your vehicle's cargo capacity.
- Installs between the rear seats only on MAX models.

<b>Front Shoulder Storage Bag</b>	Maverick X3 MAX	<b>715004888</b>	<b>\$169.99</b>
-----------------------------------	-----------------	------------------	-----------------

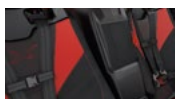

- Opens on each side so that both front and rear passengers can access the bag's content.
- Installs between the driver's and passengers' seats on MAX models.

<b>Overhead Storage Bag</b>	Maverick X3, Maverick X3 MAX	<b>715004275</b>	<b>\$127.99</b>
-----------------------------	------------------------------	------------------	-----------------



- Weather-resistant bag, holds your gear safely and securely while riding.
- Makes smart use of your overhead space to increase your vehicle's cargo capacity by 2.6 gal (10 L).
- Semi-rigid construction renders it flexible enough to fit odd-shaped loads.
- Touchscreen-compatible clear front pocket allows for easy access to your smartphone.
- Not compatible with the Bimini Roof.

<b>Upper Door Storage Bags</b>	Maverick X3, Maverick X3 MAX	<b>715004276</b>	<b>\$138.49</b>
--------------------------------	------------------------------	------------------	-----------------



- Weather-resistant, they'll hold your gear safely and securely while riding.
- Bags attach on stock quarter doors to increase your vehicle's cargo space.
- Each bag is designed as a 1.3 gal (5 L) capacity pocket also equipped with inner netting compartments.
- Semi-rigid construction renders them flexible enough to fit odd-shaped loads.
- Sold in pairs.

<b>Lower Door Panel Storage Bags</b>	Maverick X3, Maverick X3 MAX	<b>715004355</b>	<b>\$202.49</b>
--------------------------------------	------------------------------	------------------	-----------------



- Weather-resistant, they'll hold your gear safely and securely while riding.
- Bags attach on Lower Door Panels to increase your vehicle's cargo space.
- Each bag is designed as a 1.6 gal (6 L) capacity pocket also equipped with inner netting compartments.
- Semi-rigid construction renders them flexible enough to fit odd-shaped loads.
- Sold in pairs.
- Not compatible with Aluminum Half Doors.
- Lower add-on doors required for installation.

<b>Soft Storage Bag</b>	Maverick X3, Maverick X3 MAX	<b>715003759</b>	<b>\$191.49</b>
-------------------------	------------------------------	------------------	-----------------



- 11.8 gal (45 L) capacity soft cargo bag designed with vehicle's rear in mind to maximize potential storage.
- 3 sections.
- Weatherproof.

<b>Storage 2.6 Gal (10 L) Bag</b>	Maverick X3, Maverick X3 MAX	<b>269502121</b>	<b>\$40.49</b>
-----------------------------------	------------------------------	------------------	----------------



- Roll-top dry bag for fully protecting your cargo from the elements.



# SMART ACCESSORIES

Powered by the ACM, SMART Accessories respond automatically to speed, steering, and other sensor data, adjusting light output, behavior, and function in real time.

## A RESPONSE SYSTEM THAT TAKES TECH TO THE NEXT LEVEL.

### ACM

This is the brain of the SMART Ecosystem. It reads multiple sensors on the vehicle and translates the reading into actions for the accessories.

### 10.25" TOUCHSCREEN DISPLAY

When your vehicle is equipped with the 10.25" touchscreen display, it allows you to control up to 19 accessories at the same time.

### SMART CONTROL CENTER

Allows you to quickly access SMART Accessories (can be used with or without the 10.25" touchscreen display).

### SMART ACCESSORIES

Accessories designed to execute multiple functions depending on the input from the ACM.



# ACM & SMART ACCESSORIES

## ACCESSORY CONTROL MODULE (ACM)

### NEW Accessory Control Module



Maverick X3, Maverick X3 MAX  
(with touchscreen display)

715010097

\$593.99

- Bringing the SMART to accessories using live vehicle ECU information to maximize your accessory experience.
- Connect your accessories to the 10.25" Color Touchscreen Display.
- Easy accessory installation (plug and play).
- Creates an ecosystem that makes installing accessories quicker and easier.
- Includes ACM Front Harness to connect front-mounted SMART accessories to the Accessory Control Module (two auxiliary connectors available).

### NEW Rear ACM Harness

(Not illustrated)

Maverick X3, Maverick X3 MAX  
(with touchscreen display)

715009268

\$485.99

- Required to connect rear-mounted accessories and rear chase lights to the ACM.
- Creates an ecosystem that makes installing accessories quicker and easier.
- Five auxiliary connectors are available.

### NEW SMART Control Center for ACM



Maverick X3, Maverick X3 MAX  
(with touchscreen display)

715010834

\$534.99

- Control the accessories with the selection of different modes, the illuminated halo around the button indicates the active mode.
- Icons illuminate when accessories are activated.
- Make accessory control changes without having to take your eyes off the trail by choosing the accessory button required (quick access).
- All Front LED Off button to turn off all front lights with one click. Remembers the last programmed setups when this button is pressed again.
- 6 pre-programmed buttons (Light Bars, PowerFlip Windshield, All Front LED Off, Corner Lights) and 10 programmable buttons to customize according to the accessories installed.
- Requires Accessory Control Module.

## SMART ACCESSORIES

### NEW SMART Integrated LED Roof Light



Maverick X3, Maverick X3 MAX (2020 & up)

715010102

\$1,309.94

- Mounted under the roof for a signature look.
- Windshield compatible except with the PowerFlip.
- Intensity varies (increases or decreases) according to the speed of the vehicle with the installation of the Accessory Control Module (ACM) (Spot/Flood ratio).
- Spot/Flood combo beam.
- 22,100 lumens.
- Off/Low/High (switch activated).
- Off/Low/High/SMART Automatic Mode (Accessory Control Module (ACM) activated).
- Accessory Control Module (715010097) is required for SMART functionality.
- Integrated LED Roof Light Wiring Harness (715008209) is required for on/off function when ACM is not installed. Sold separately.
- Not compatible with PowerFlip Windshield (715007097).

### NEW SMART 10" (25 cm) LED Light Bar



Maverick X3, Maverick X3 MAX

715008745

\$374.49

- The perfect combination of powerful white and selective yellow LEDs.
- The selective yellow LEDs are ideal for driving in low visibility conditions.
- The light is composed of 16 white LEDs and 8 yellow LEDs.
- Spot and Flood combo beam.
- The side lens design provides highly effective wide-angle illumination.
- The white LEDs produce 8,100 raw lumens and the selective yellow 2,640 raw lumens, delivering stunning lighting performance.
- The lens is made from hard-coated polycarbonate.
- IP67 and IP69k submersible and pressure washer safe.
- Switch options: Off, Low and High. Color change by flicking the switch quickly.
- SMART options: Off, Low, High, color change and SMART Automatic Mode.
- SMART MODE: Intensity increases or decreases and Spot/Flood ratio varies according to the speed of the vehicle with the installation of the Accessory Control Module (ACM).
- Accessory Control Module (715010097) is required for SMART functionality.
- Wiring Harness (715009886) is required for on/off function when ACM is not installed. Sold separately.
- Just a heads-up, you'll need a bumper for this.

**NEW SMART 40" (102 cm) LED Light Bar** | Maverick X3, Maverick X3 MAX | **715008747** | **\$1,069.99**



- The perfect combination of a powerful white or selective yellow LEDs.
- The selective yellow LEDs are ideal for driving in low visibility conditions.
- The light is composed of 64 white LEDs and 32 yellow LEDs.
- Spot and Flood combo beam.
- The side lens design provides highly effective wide-angle illumination.
- The white LEDs produce 32,000 raw lumen, and the selective yellow 10,560 raw lumens, delivering stunning lighting performance.
- The lens is made from hard-coated polycarbonate.
- IP67 and IP69k submersible and pressure washer safe.
- Switch options: Off, Low and High. Color change by flicking the switch quickly.
- SMART options: Off, Low, High, color change and SMART Automatic Mode.
- SMART MODE: Intensity increases or decreases and Spot/Flood ratio varies according to the speed of the vehicle with the installation of the Accessory Control Module (ACM).
- Accessory Control Module (715010097) is required for SMART functionality.
- See table for installation location and requirements.

**NEW SMART LED Chase Lights** | Maverick X3, Maverick X3 MAX | **715007727** | **\$705.99**



- Designed by Can-Am to make you visible to vehicles riding behind you, especially in dusty or harsh conditions.
- Four modes available:
  - Trail Mode: serves as a taillight and as a brake light.
  - Chasing Mode: displays amber light pattern and serves as a brake light.
  - Work Mode: White light to light up your cargo bed.
  - Reverse Mode (when connected with Accessory Control Module (ACM)): serves as a back up light.
- Modular to allow installation with rear roll cage mounted accessories.
- Plug-and-play installation with the Accessory Control Module (ACM).
- Accessory Control Module (715010097) and Rear ACM Harness (715009268) are required for SMART functionality.
- Wiring harness required for a non-smart function when ACM is not installed. Sold separately.

**Integrated LED Side Mirror Lights** | Maverick X3, Maverick X3 MAX | **715007185** | **\$342.49**



- Light up corners.
- Increase the width of the beams and illuminate the wheels for increased visibility.
- Wide flood beam.
- 3,000 lumens for each light.
- Left and right dynamic lighting with Accessory Control Module (ACM) install. Follow steering wheel input.
- Accessory Control Module (715010097) is required for SMART functionality.
- Require Aluminum Side Mirrors (715007363).
- Electric Harness required (715008212) to hook up and operate the Integrated LED Side Mirror Lights for on/off function when ACM is not installed. Sold separately.

# LIGHTS

## CAN-AM LIGHTS WITH ACM

		2 CHOOSE YOUR LIGHTS				
1 CHOOSE YOUR MOUNT POINT		SMART Integrated LED Roof Light 715010102	SMART Integrated LED Side Mirror Lights 715007185	SMART LED Chase Lights 715007727	SMART 40" (102 cm) LED Light Bar 715008747	SMART 10" (25 cm) LED Light Bar 715008745
<b>SMART FUNCTIONALITY</b>	<b>Vehicle Integrated</b>	Accessory Control Module 715010097	Aluminum Side Mirrors 715007363 + Accessory Control Module 715010097	Accessory Control Module 715010097 + Rear ACM Harness 715009268	No compatibility	No compatibility
	<b>Front Bumper</b> (except XMR/XRC and Lonestar)	No compatibility				Accessory Control Module 715010097
	<b>Sport Roof with Light Support Bar</b> 715003529				No compatibility	
	<b>Audio Roof</b> (no additional bracket needed)	Accessory Control Module 715010097	No compatibility			
<b>Adventure Roof Rack</b> 715006225, 715003868, 715007186	No compatibility			Accessory Control Module 715010097	No compatibility	

## CAN-AM LIGHTS WITHOUT ACM

		2 CHOOSE YOUR LIGHTS				
1 CHOOSE YOUR MOUNT POINT		SMART Integrated LED Roof Light 715010102	SMART Integrated LED Side Mirror Lights 715007185	SMART LED Chase Lights 71500727	SMART 40" (102 cm) LED Light Bar 715008747	SMART 10" (25 cm) LED Light Bar 715008745
ON/OFF FUNCTIONALITY	Vehicle Integrated	Wiring Harness 715008209	Aluminum Side Mirrors 715007363 + Wiring Harness 715008212	Wiring Harness 715008210	No compatibility	No compatibility
	Front Bumper (except XMR/XRC and Lonestar)	No compatibility				Lights Wiring Harness 715009886
	Sport Roof with Light Support Bar 715003529	No compatibility				No compatibility

		2 CHOOSE YOUR LIGHTS									
1 CHOOSE YOUR MOUNT POINT		BAJA DESIGNS <sup>†</sup> LIGHTS					CAN-AM LIGHTS				
		10" (25 cm) LED Light Bar	40" (102 cm) Baja Design OnX6 Arc LED Light Bar	XL Sport LED Lights (sold in pairs)	Squadron Sport LED Lights (sold in pairs)	XL80 LED Lights (sold in pairs)	10" Double Stacked LED Bar	15" Double Stacked LED Bar	39" Double Stacked LED Bar	4" Round LED Lights (sold in pairs)	3.5" Spot or Flood LED Lights (sold in pairs)
Front Pre-runner or Dune Bumpers	710006819 + 715007049 (Power Cable)	710006818 + 715008864 (Power Cable)	710006821 + 715008865 (Power Cable)	710006820 + 715008865 (Power Cable)	710005041 + 715007049 (Power Cable)	715002933 + 715003417 (Power Cable)	715002934 (Not compatible with Pre-runner Bumper) + 715003417 (Power Cable)	No compatibility	715002934 (Not compatible with Pre-runner Bumper) + 715003417 (Power Cable)	715002935 (4" Round), 715009774 (3.5" Flood) or 715009775 (3.5" Spot) + 715003417 (Power Cable)	
Lonestar Racing Front Bumper	NA	710006821 + 715008865 (Power Cable)	710006820 + 715008865 (Power Cable)	710005041 + 715007049 (Power Cable)	No compatibility						
Light Support Bar or Adventure Roof Rack	NA	710006818 + 715008864 (Power Cable)	710006821 + 715008865 (Power Cable)	710006820 + 715008865 (Power Cable)	710005041 + 715007049 (Power Cable)	715002934 + 715003417 (Power Cable)	715002934 + 715003417 (Power Cable)	715004007 + 715005822 (Light Mounting Kit)			
Lonestar Racing 40" (102 cm) LED Light Bar Rack	NA	710006818 + 715008864 (Power Cable)	NA	NA	NA	NA	NA	NA	NA	NA	NA
Lonestar Racing Light Rack	NA	NA	710006821 + 715008865 (Power Cable)	NA	710005041 + 715007049 (Power Cable)	NA	NA	NA	NA	NA	NA

### 3 ORDER

#### ORDER ALL PART NUMBERS IN INTERSECTING BOX

\*Note: When installing more than one light kit, additional light power cable or mounting kit is required.

\*All lights are intended for off-road use only.

<b>40" (102 cm) Baja Designs OnX6 Arc LED Light Bar</b>	Maverick X3, Maverick X3 MAX	<b>710006818</b>	<b>\$2,149.99</b>
---	------------------------------	------------------	-------------------



**29,000 lumens**

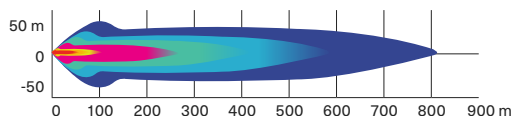

- 252 W light bar producing 29,000 lumens.
- Equipped with 24 Cree XM-L2 LEDs.
- Driving/combo light pattern for smooth blend of light for both near field applications and distance.
- Designed for installation onto Light Support Bar equipped roofs.
- Requires Light Power Cable and Light Support Bar.
- See table for installation location and requirements.

<b>Baja Designs 10" (25 cm) OnX6 LED Light Bar</b>	Maverick X3, Maverick X3 MAX	<b>710006819</b>	<b>\$591.49</b>
--	------------------------------	------------------	-----------------



**12,460 lumens**

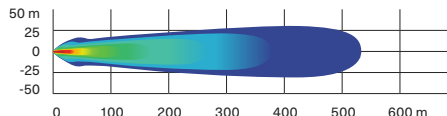

- 108 W light bar producing 12,460 lumens.
- Equipped with 6 Cree XM-L2 LEDs.
- Driving/combo light pattern for smooth blend of light for both near field applications and distance.
- Dual intensity (high/low) settings.
- Requires Baja Designs Light Power Cable.
- See table for installation location and requirements.

<b>Baja Designs XL80 LED Lights</b>	Maverick X3, Maverick X3 MAX	<b>710005041</b>	<b>\$1,117.99</b>
-------------------------------------	------------------------------	------------------	-------------------



**9,500 lumens**

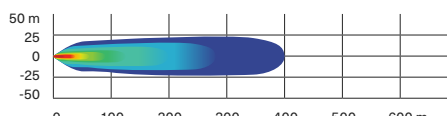

- 80 W per spot producing 9,500 lumens.
- Equipped with 4 Cree XHP50 LEDs per spot.
- Dual intensity (high/low) settings.
- Driving/combo light pattern for smooth blend of light for both near field applications and distance.
- Require Baja Designs Light Power Cable.
- Sold in pairs.
- Dimensions: 4.5" x 4.5" (11.4 cm x 11.4 cm).
- See table for installation location and requirements.

<b>Baja Designs Squadron Sport LED Lights</b>	Maverick X3, Maverick X3 MAX	<b>710006820</b>	<b>\$309.99</b>
---	------------------------------	------------------	-----------------



**3,150 lumens**

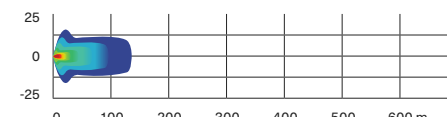

- 26 W per spot producing 3,150 lumens.
- Equipped with 4 Cree XP-G2 LEDs per spot.
- Wide cornering light pattern designed specifically for cornering, dust and/or fog conditions.
- Require Baja Designs Light Power Cable.
- Sold in pairs.
- Dimensions: 3" x 3" (7.6 cm x 7.6 cm).
- See table for installation location and requirements.

<b>Baja Designs XL Sport LED Lights</b>	Maverick X3, Maverick X3 MAX	<b>710006821</b>	<b>\$529.99</b>
---	------------------------------	------------------	-----------------



**3,150 lumens**

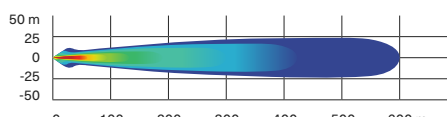

- 26 W per spot producing 3,150 lumens.
- Equipped with 4 Cree XP-G2 LEDs per spot.
- High Speed Spot features a longer and narrower beam focus for illumination farther down.
- Require Baja Designs Light Power Cable.
- Sold in pairs.
- Dimensions: 4.5" x 4.5" (11.4 cm x 11.4 cm).
- See table for installation location and requirements.

**Lights Power Cable**

*(Not illustrated)*

Maverick X3, Maverick X3 MAX

<b>715003417</b>	<b>\$74.49</b>
<b>715007049</b>	<b>\$117.49</b>
<b>715008865</b>	<b>\$160.99</b>
<b>715008864</b>	<b>\$160.99</b>

- Required for installation of Baja Designs LED lights onto roof or bumper.
- 10" (25 cm) Baja Designs OnX6 LED Bars and Baja Designs XL80 LED Lights (715007049).
- Baja Designs XL Sport LED Lights and Baja Designs Squadron Sport LED Lights (715008865).
- 40" (102 cm) Arc LED Light Bar ONX6 (715008864).

**10" (25 cm) Double Stacked LED Light Bar (60 W)**

Maverick X3, Maverick X3 MAX

**715002933**

**\$395.49**



**5,400 lumens**

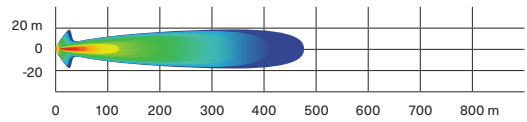

- Equipped with twelve 5 W Cree LEDs.
- 5,400 lumens.
- Packs a big punch for its size.
- Rugged and waterproof.
- Requires light power cable for installation.

- Lights up to more than 1,500 ft. (460 m) in front of the vehicle and around 65 ft. (20 m) wide on each side.
- EC compliant.
- See table for installation location and requirements.

**15" (38 cm) Double Stacked LED Light Bar (90 W)**

Maverick X3, Maverick X3 MAX

**715002934**

**\$480.99**



**8,400 lumens**

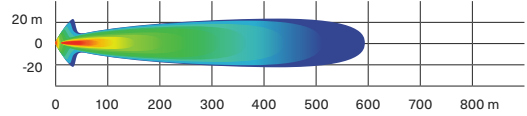

- Equipped with 18 5 W Cree LEDs.
- 8,400 lumens.
- Complements the Light Racks and most bumpers.
- Rugged and waterproof.

- Lights up to more than 1,900 ft. (580 m) in front of the vehicle and around 65 ft. (20 m) wide on each side.
- EC compliant.
- See table for installation location and requirements.

**39" (99 cm) Double Stacked LED Light Bar (270 W)**

Maverick X3, Maverick X3 MAX

**715004007**

**\$940.99**



**24,300 lumens**

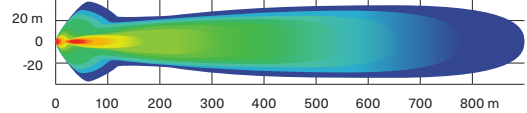

- Equipped with 54 5 W Cree LEDs.
- 24,300 lumens.
- Lights up to more than 2,900 ft. (900 m) in front of the vehicle and around 115 ft. (35 m) wide on each side.

- Compatible with the Adventure Roof Rack.
- Requires light power cable for installation.

**4" (10 cm) Round LED Lights (2 x 25 W)**

Maverick X3, Maverick X3 MAX

**715002935**

**\$480.99**



**1,800 lumens**

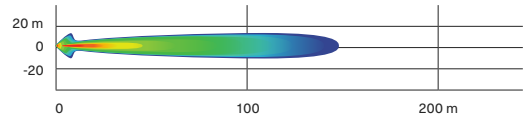

- 25 W LED spotlights.
- 1,800 lumens.

- Rugged and waterproof.
- Includes basic wiring and switch.

- Can-Am branded grill.
- Requires light power cable.
- Sold in pairs.

- Not EC compliant.
- Requires light power cable for installation.

**3.5" (9 cm) LED Driving Lights (2 x 14 W)**

Maverick X3, Maverick X3 MAX

**715009775**

**\$283.49**



**1,260 lumens**

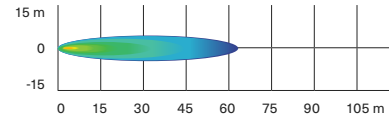

- 14 W LED lights producing 1,260 lumens each.
- Spot lens for a narrow and long light beam spread, ideal when driving at higher speeds.
- Equipped with six high-power LEDs in a heavy-duty die-cast aluminum housing.

- Features two attachment points. If one attachment point fails due to a collision, rotate to the next channel point and remount the light.
- Sold in pairs.
- EC compliant.
- Requires light power cable for installation.

### 3.5" (9 cm) LED Flood Lights (2 x 14 W)

Maverick X3, Maverick X3 MAX

715009774

\$283.49

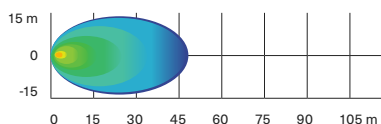

- 14 W LED lights producing 1,260 lumens each.
- Flood lens for a wide light beam spread, ideal for working applications like plowing or cornering. Suitable for dusty or foggy riding conditions.
- Equipped with six high-power LEDs in a heavy-duty die-cast aluminum housing.
- Features two attachment points. If one attachment point fails due to a collision, rotate to the next channel point and remount the light.
- Sold in pairs.
- EC compliant.
- Requires light power cable for installation.

### Can-Am LED Signature Lights

Maverick X3, Maverick X3 MAX

715003673

\$259.99



- Add style with a more aggressive look.
- Use bright and energy efficient LEDs.
- Do not give additional lighting for driving.

### NEW Dome Light

Maverick X3, Maverick X3 MAX

715009228

\$96.49



- Offers an optimal visibility in the cab and integrates perfectly with the vehicle.
- 160 lumens of soft white light ensure clear visibility of the surroundings.
- Built in on/off button on the light.
- Wiring included.
- Can be installed on cage, Sport Roof or All-Terrain Trunk Cover.
- Not compatible with Audio Roof.

### Lonestar Racing 40" (102 cm) LED Light Bar Rack

Maverick X3, Maverick X3 MAX

715003920

\$379.99



- Designed for use with 40" (102 cm) Baja Designs OnX6 Arc LED Light Bar.
- Enhances the vehicle's race-inspired look.
- Compatible with Aluminum Roof, Lonestar Racing Aluminum Roof and Sport Roof.
- Not compatible with Racing Side Mirrors and PowerFlip Windshield.
- Lights sold separately.

### Lonestar Racing Light Rack

Maverick X3, Maverick X3 MAX

715003948

\$379.99



- Designed for use with Baja Designs XL80 LED Light and Baja Designs XL Sport LED Light.
- Accommodates up to two pairs of XL Lights.
- Not compatible with Racing Side Mirrors and PowerFlip Windshield.
- Compatible with Lonestar Racing Aluminum Roof, Aluminum Roof and Sport Roof.
- Lights sold separately.

### Chase Lights

Maverick X3, Maverick X3 MAX

715002887

\$791.49



- Designed by Can-Am to make you visible to vehicles riding behind you, especially in dusty or harsh conditions.
- Feature in-dash switches to activate one of the two modes and to choose among 11 different high-visibility colored light patterns (blue, red and yellow).
- Trail Mode: Serves as a tail light and as a brake light.
- Chasing Mode: Displays amber and blue light patterns and serves as a brake light (brake light function can be deactivated for racing applications).
- Modular to allow installation with rear roll cage mounted accessories.
- Plug-and-play installation.
- Verify your local regulations concerning the use of blue lighting.

### LED Chase Lights

Maverick X3, Maverick X3 MAX

715009887

\$705.99



- Designed by Can-Am to make you visible to vehicles riding behind you, especially in dusty or harsh conditions.
- High-visibility colored light patterns (red, yellow, white).
- Three modes available:
  - Trail Mode: serves as a tail light and as a brake light.
  - Chasing Mode: displays amber light pattern.
  - Work Mode: white light to light up your cargo bed.
- Modular to allow installation with rear roll cage mounted accessories.
- Plug-and-play installation.
- Wiring Harness required (715008210). Sold separately.
- Can be installed with roof scoop but only with the lateral light.

<b>Light Support Bar</b>	Maverick X3, Maverick X3 MAX	<b>715003529</b>	<b>\$271.49</b>
--------------------------	------------------------------	------------------	-----------------



- Sleekly styled rugged aluminum construction.
- Accommodates light bars and spotlights with or without any roof and windshield combination.
- Full vehicle width to allow the installation of any large LED light bar.
- Required for light installation on vehicle's roof.
- Not compatible with Lonestar Racing Aluminum Roof.
- Lights sold separately.

<b>Mounting Kit for 39" (99 cm) LED Light Bar</b> <i>(Not illustrated)</i>	Maverick X3, Maverick X3 MAX	<b>715005822</b>	<b>\$170.99</b>
---	------------------------------	------------------	-----------------

- Required for installation of the 39" (99 cm) double stacked LED Light Bar.
- Includes wiring and support bracket.
- Light Support Bar required for installation.

<b>NEW Lights Wiring Harness</b>	Maverick X3, Maverick X3 MAX	<b>715009886</b>	<b>\$85.59</b>
----------------------------------	------------------------------	------------------	----------------



- Power cable for installation of the SMART 10" (25 cm) LED Light Bar (715008745).

<b>Light Power Cable</b> <i>(Not illustrated)</i>	Maverick X3, Maverick X3 MAX	<b>715003417</b>	<b>\$74.49</b>
--	------------------------------	------------------	----------------

- Required for installation of 10" (25 cm), 15" (38 cm) and Double Stacked LED Light Bars and 4" (10 cm) Round LED Lights.
- For bumper and roof mounting locations.



# YOUR SOUND, YOUR WAY

Choose the audio setup that matches your style.

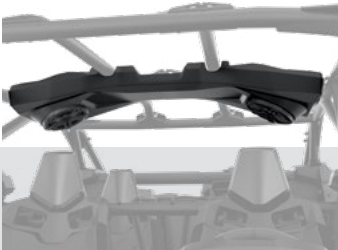

## MTX CENTRAL SPEAKERS

This option includes a top mounted central speaker case with two 6.5" 100-watt speakers PLUS a 10" under-seat 250-watt amplifier.



## AUDIO ROOF

This option includes a full roof with four or six 8" speakers, one 400 RMS, and an 800 peak watt amplifier supplied by Rockford Fosgate audio.



## COMPLETE MTX AUDIO SYSTEM

This option includes front-dashboard and rear-roll-cage mounted stereo speakers and head unit with an integrated 6.5" subwoofer.

# LEVEL UP WITH UPGRADES

Bring the thunder wherever you roll with an amplifier or a subwoofer for even bigger sound on every ride.

# AUDIO & COMMUNICATION SYSTEMS

## AUDIO

<b>Can-Am Rockford Fosgate Audio Roof – Level 4</b>	Maverick X3 (with touchscreen display) Maverick X3	<b>715010098 NEW</b> <b>715007130</b>	<b>\$2,995.99</b> <b>\$3,530.99</b>
	<ul style="list-style-type: none"> <li>• Full roof with sleek built-in audio.</li> <li>• Fully sealed and waterproof.</li> <li>• Easy to install: one wire connects the roof to the vehicle's electronics.</li> <li>• Four 8" speakers, one 400 RMS and 800 peak watt amplifier calibrated by Rockford Fosgate Audio.</li> <li>• Multi-colored RGB LED accent lighting around each speaker.</li> <li>• 2.7" color display with Bluetooth and Pandora connectivity (715007130).</li> <li>• Controlled by the 10.25" Color Touchscreen Display (715010098).</li> <li>• Flip Kit-compatible.</li> <li>• Not compatible with the Adventure Roof Rack if the Flip Kit is installed.</li> <li>• Not compatible with the Upper Soft Door Panels.</li> </ul>		
<b>Can-Am Rockford Fosgate Audio Roof MAX – Level 4</b>	Maverick X3 MAX (with touchscreen display) Maverick X3 MAX	<b>715010099 NEW</b> <b>715006709</b>	<b>\$4,386.99</b> <b>\$4,921.99</b>
	<ul style="list-style-type: none"> <li>• Full roof with built-in audio.</li> <li>• Fully sealed and waterproof.</li> <li>• Easy to install, one wire connects the roof to the vehicle's electric system.</li> <li>• Six 8" speakers, one 400 RMS and 800 peak watt amplifier calibrated by Rockford Fosgate Audio.</li> <li>• Multi-colored RGB LED accent lighting around each speaker.</li> <li>• 2.7" color Display with Bluetooth and Pandora connectivity (715007130).</li> <li>• Controlled by the 10.25" Color Touchscreen Display (715010099).</li> <li>• Not compatible with the Adventure Roof Rack if the Flip Kit is installed.</li> <li>• Not compatible with the Upper Soft Door Panels.</li> </ul>		
<b>Can-Am Audio Roof Flip Kit</b>	Maverick X3, Maverick X3 MAX	<b>715007131</b>	<b>\$491.99</b>
	<ul style="list-style-type: none"> <li>• Combines with Audio Roof (715007130 or 715006709) for Flip option.</li> <li>• Not compatible with the Racing Side Mirrors (715002898).</li> </ul>		
<b>MTX Central Speakers</b>	Maverick X3 MAX	<b>715004748</b>	<b>\$887.49</b>
	<ul style="list-style-type: none"> <li>• Top mounted central speaker case holding two 6.5" (16.5 cm)/100 W speakers.</li> <li>• Designed to be Can-Am-tough in the most demanding riding conditions.</li> <li>• Perfect add-on to the Complete MTX Audio System for a 7-speaker system or as a stand-alone system by plugging the AUX input jack directly into your music device.</li> <li>• Not compatible with Lonestar roofs.</li> </ul>		
<b>Complete MTX Audio System</b>	Maverick X3, Maverick X3 MAX	<b>715002873</b>	<b>\$1,549.99</b>
	<ul style="list-style-type: none"> <li>• Bluetooth 5<sup>1</sup> equipped 400 W RMS/800 W peak audio system by MTX.</li> <li>• Designed to be Can-Am-tough in the most demanding riding conditions.</li> <li>• Includes front-dashboard and rear-roll-cage mounted stereo speakers and head unit with an integrated 6.5" (16.5 cm) subwoofer.</li> <li>• Add the Electronic Device Holder to securely hold your Bluetooth device ready to play your favorite tunes.</li> </ul>		
<b>Can-Am Subwoofer</b>	Maverick X3, Maverick X3 MAX	<b>715004956</b>	<b>\$630.99</b>
	<ul style="list-style-type: none"> <li>• Powerful Rockford Fosgate Underseat 10" Subwoofer speaker box.</li> <li>• Easy plug-and-play connections to Audio Roof system.</li> <li>• Sturdy construction tough enough to withstand harsh environments and sealed against moisture and dirt.</li> <li>• Requires 1 Amplifier Kit (715007227) for 1 or 2 subwoofers.</li> <li>• Fits two per vehicle: under driver's or passenger's seat.</li> </ul>		
<b>Can-Am Amplifier Kit</b>	Maverick X3, Maverick X3 MAX	<b>715007227</b>	<b>\$641.99</b>
	<ul style="list-style-type: none"> <li>• A powerful 400 W amplifier to feed up to two Underseat Subwoofers.</li> <li>• Easy plug-and-play connections to Audio Roof system and subwoofer.</li> <li>• Installation plate and wiring included.</li> </ul>		
<b>Electronic Device Holder</b>	Maverick X3, Maverick X3 MAX	<b>715002874</b>	<b>\$106.49</b>
	<ul style="list-style-type: none"> <li>• A great in-ride entertainment system platform.</li> <li>• Robust injected-polypropylene construction allows for right fit and easy installation.</li> <li>• Adjustable unit safely holds most tablets and smartphones measuring between 5.1" (13 cm) and 10" (25.4 cm) (with protective case).</li> <li>• Combines seamlessly with Complete MTX Audio System and Rugged Radios Intercom System.</li> <li>• Allows the installation of Garmin Montana 680T GPS.</li> <li>• Integrated storage (1 gal [3.8 L] capacity) with access to the dash 12V outlet for device charging.</li> </ul>		

# ELECTRICAL & ELECTRONIC ACCESSORIES

## ELECTRICAL

<b>Seat Heater</b>	Maverick X3, Maverick X3 MAX	<b>715006112</b>	<b>\$144.99</b>
--------------------	------------------------------	------------------	-----------------

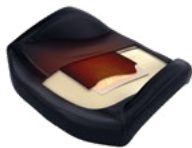

- 25 W seat heater delivers chill-free riding comfort.
- High/low temperature settings allow you to control the desired degree of warmth.
- This kit includes one carbon fiber seat heater, foam sheet and in-dash switch.
- Installs directly in the original seat cushion.
- Heated Accessories Wiring Harness (710005757) is required for front seat installation.
- Heated Accessories Wiring Harness (715006004) is required for rear seat installation.

<b>Heated Visor Outlet</b>	Maverick X3, Maverick X3 MAX	<b>715001246</b>	<b>\$60.99</b>
----------------------------	------------------------------	------------------	----------------



- Strategically positioned on vehicle to maintain your agility.
- Optional visor outlet that delivers fog-free riding.
- Quick and easy installation.
- Sold individually.
- Heated Visor not included.

<b>Heated Accessories Wiring Harness</b> <i>(Not illustrated)</i>	Maverick X3, Maverick X3 MAX	<b>710005757</b>	<b>\$127.99</b>
	Maverick X3 MAX	<b>715006004</b>	<b>\$189.99</b>

- Electric harness required to hook up and operate front heated seats, heated steering wheel and heated grab bar.
- Heated Accessories Wiring Harness (715006004) is required for rear seat installation.

<b>Auxiliary Battery Installation Kit</b> <i>(Not illustrated)</i>	Maverick X3, Maverick X3 MAX	<b>715006315</b>	<b>\$319.49</b>
---	------------------------------	------------------	-----------------

- Allows you to add a second 18 Ah battery for a dual battery setup necessary to power auxiliary electrical components such as sound systems or winches.
- Equipped with an IP67-rated waterproof electronic module that will prevent your auxiliary electrical components from draining your starting battery.
- Kit includes an additional battery junction block, all necessary wiring and the battery holder.
- Both batteries are perfectly integrated, in stock location, behind the passenger's seat.
- Additional battery (410301203), plus battery hardware (250000282) sold separately.

## ELECTRONIC

<b>Cellphone Holder</b>	Maverick X3, Maverick X3 MAX	<b>715008786</b>	<b>\$106.99</b>
-------------------------	------------------------------	------------------	-----------------



- Water resistant door allows for perfect phone positioning.
- Features capacitive and resistive touch screen technology.
- Spring system in back plate automatically adjusts for thickness.
- Fits all cellphones within 7.2" (185 mm) x 3.3" (85 mm) x 0.6" (15 mm) dimensions.
- Works with almost all charger wires.
- Does not include cellphone or charging wires.
- Requires the Electronic Device Holder (715002874) for the Cellphone Holder to be bolted on its door.

<b>Lighted Whip Flag</b>	Maverick X3, Maverick X3 MAX	<b>715002886</b>	<b>\$331.49</b>
--------------------------	------------------------------	------------------	-----------------



- A must for riding the dunes.
- 5 W Cree LED.
- 5 colored lenses to allow personalization.
- Glow-through whip, quickly removable and replaceable pole.
- Increases vehicle's visibility.
- Meets most dune-area requirements.
- Die cast aluminum base, acetal hand nut.
- Includes mounting brackets and wiring.
- 4' (1.2 m) flag mounts on top of the roll cage.
- Can be installed on both sides of a vehicle.

<b>Quick Connect Battery Cable</b>		<b>715005408</b>	<b>\$11.07</b>
------------------------------------	--	------------------	----------------



- Quickly and easily connect and charge different batteries with your charger.
- Included in the Battery Charger/Maintainer.
- Sold individually.

<b>Quick Connect Cable with Battery Indicator</b>		<b>715006055</b>	<b>\$23.99</b>
---	--	------------------	----------------



- Quickly and easily connect and charge different batteries with your charger.
- 3-color LED indicator provides constant battery health indication.
- Sold individually.

**Digitally Encoded Security System (D.E.S.S.™)  
Green Key**

Maverick X3 (except 900 HO)

**710005232**

**\$63.49**



- Top-security anti-theft protection for your vehicle.
  - Encrypted chip technology restricts access to your vehicle's electronic ignition system.
  - One vehicle/one code.
  - A vibration/shock-resistant ball-and-socket design that ensures a reliable connection.
- 2 programmable modes:
    - Normal mode: configurable vehicle speed limit between 50 km/h (31 mph) and 136 km/h (85mph) and may have engine torque reduction.
    - Performance mode: No restrictions.

# WINCHES & HITCHES

## CAN-AM HD WINCHES

### Can-Am HD 4500 Winch

Maverick X3, Maverick X3 MAX

**715006416**

**\$384.99**



- Ergonomic clutch handle.
  - Rugged all-steel gears and bushings for more torque and durability.
  - Automatic 100% load-holding brake.
  - Sealed solenoid for all-weather protection.
  - Weather sealed corded remote and dash mounted switch.
- EC compliant.
  - Pulling strength capability of 4,500 lb (2,041 kg).
  - 43' of 1/8" (13.1 m of 6.3 mm) wire steel cable.
  - Heavy-duty 4-way roller fairlead.
  - Winch Electrical Harness (715003585) and winch compatible front bumper are required.

### Can-Am HD 4500-S Winch

Maverick X3, Maverick X3 MAX

**715006417**

**\$513.49**



- Ergonomic clutch handle.
  - Rugged all-steel gears and bushings for more torque and durability.
  - Automatic 100% load-holding brake.
  - Sealed solenoid for all-weather protection.
  - Weather-sealed corded remote and dash mounted switch.
- Pulling strength capability of 4,500 lb (2,041 kg).
  - 50' of 1/4" (15.2 m of 6.35 mm) synthetic rope.
  - Corrosion-proof aluminum Hawse fairlead.
  - Winch Electrical Harness (715003585) and winch compatible front bumper are required.

## WINCH ACCESSORIES

### **NEW** Winch Cable Stopper

All Can-Am HD Winches

**715009921**

**\$21.29**



- Made of EPDM, a highly durable synthetic rubber.
- The Winch Cable Stopper isn't just for looks. It helps extend the life of the winch, rope, hook, and fairlead.
- In addition, the split design makes it easy to install.

### Can-Am HD Hawse Fairlead

Can-Am HD Winch

**715006426**

**\$61.49**



- A must when upgrading your winch with a synthetic cable, this corrosion-proof aluminum Hawse fairlead will prevent the cable from snapping in a corner of a roller fairlead and from wearing prematurely due to the rough surface of the worn roller guide.
- Must be used with synthetic cables only.

### WARN Hawse Fairlead

WARN Winch

**715007785**

**\$114.99**



- Double-powder-coated construction.
- To be used with synthetic winch cables only.

### Synthetic Winch Cable

Can-Am HD Winch

**715006430**

**\$158.99**

WARN Winch

**715007783**

**\$169.99**



- 50' of 1/4" (15.2 m of 6.35 mm) synthetic cable for Can-Am HD winches.
- Can-Am HD Hawse Fairlead (715006426) is required when upgrading to a synthetic cable to avoid premature cable damage and wear.
- WARN Hawse Fairlead (715007785) is required when upgrading to a synthetic cable to avoid damage and premature wear of the cable.

<b>Wire Rope Replacement</b>	Can-Am HD Winch	<b>705014978</b>	<b>\$23.99</b>
	WARN Winch	<b>715006699</b>	<b>\$82.99</b>



- 43' of 1<sup>5</sup>/<sub>64</sub>" (14.3 m of 6.3 mm) wire rope for Can-Am HD Winch.
- 55' of 1/4" (16.8 m of 6.35 mm) wire rope for WARN winch kit.
- 4,500 lb (2,041 kg) pulling strength.

<b>Synthetic Cable Extension</b>	<b>715001120</b>	<b>\$174.99</b>
----------------------------------	------------------	-----------------



- Lightweight 1/4" (6.35 mm) diameter, easy to handle and won't rattle in cargo box.
- Easily attaches to winch cable to provide additional 50' (15.2 m) of distance.
- 4,500 lb (2,041 kg) single line capacity.

<b>Winch Electrical Harness</b> <i>(Not illustrated)</i>	Maverick X3, Maverick X3 MAX	<b>715003585</b>	<b>\$160.49</b>
---	------------------------------	------------------	-----------------

- Required for winch installation.

<b>Rear Winch Harness</b> <i>(Not illustrated)</i>	<b>715006007</b>	<b>\$235.49</b>
---	------------------	-----------------

- Required for installation of a winch on the S3 Rear Winch Bumper.

<b>NEW Wireless Winch Remote</b>	With Can-Am HD Winch	<b>715008286</b>	<b>\$159.74</b>
----------------------------------	----------------------	------------------	-----------------



- On/Off and Winch In / Winch Out buttons with LED indicator light.
- Large Winch In / Winch Out buttons for easy activation with gloves.
- Ergonomic remote handle shape with a trigger-like holding protrusion.
- Quick and easy to install, thanks to a wiring harness with an integrated antenna and all necessary mounting hardware.
- Allows you to operate your winch from anywhere within a 50' (15.2 m) radius, increasing your recovery options.
- All components are IP67 sealing rated.
- The remote also floats in case it's dropped during a deep water recovery.
- Dash and handlebar mounting options.
- Compatible with all Can-Am HD winches.

<b>Wired Remote Control</b>	Can-Am HD Winch†	<b>715006504</b>	<b>\$26.49</b>
-----------------------------	------------------	------------------	----------------



- This kit allows winch owners to add the hand-held remote to vehicles with a stock winch.
- OEM stock winch is sold separately.
- EC compliant.

† *Harness (710001023) is required to use remote control on a vehicle with a factory installed winch.*  
‡ *Remote control (710007050) and connection socket are included.*

<b>X rc/X mr Rear Tow Hook</b>	Maverick X3, Maverick X3 MAX 2021 & prior	<b>715004450</b>	<b>\$85.99</b>
--------------------------------	---	------------------	----------------



- Offers a solid place to hook onto in case towing is needed.
- Allows you to attach most straps and hooks.
- Made of rugged 3/16" (5 mm) steel plate and 5/8" (16 mm) steel hook tube.
- Standard on Maverick X rc and X mr models.

## HITCHES

<b>Rear Hitch</b>	Maverick X3, Maverick X3 MAX 2021 & prior	■ <b>715002883</b> • Black	<b>\$154.49</b>
		■ <b>715003938</b> • Can-Am Red	<b>\$196.99</b>



- Rugged lightweight steel construction.
- E-coated finish.
- Fixed mounting point for trailer ball to provide vehicle with towing capabilities.
- This hitch offers 1,300 lb (590 kg) of towing capacity.
- Hitch ball not included.

# PERFORMANCE

## Performance Half Shaft



Maverick X3, Maverick X3 MAX  
Maverick X3, Maverick X3 MAX

705401634 - 64"  
705402048 - 72"

\$275.49  
\$275.49

- High-performance design ideal for off-road use, with superior protection in any riding usage.
- Includes CVs, shaft and boots with the best suited geometry for your Can-Am vehicle.
- Required to install the Smart-Lok™ Differential Kit.

## Mud Smart Mode Module

(Not illustrated)

Maverick X3, Maverick X3 MAX with Smart-Lok Differential (except Turbo RR models 2021 & up)

715005282

\$191.49

- This module allows you to add the Mud Smart Mode to vehicles with the Smart-Lok Differential Kit sold as an accessory or to change to the Mud Smart Mode on vehicles equipped with a standard Smart-Lok.
- The Mud Mode has been specially designed to deliver superior traction in the deepest mud holes.
- When high engine torque and/or slippage is detected, Smart-Lok will fully lock the front end.
- The system will stay locked until throttle release.
- Only one Smart Mode Module can be installed at a time.

## Rock Smart Mode Module

(Not illustrated)

Maverick X3, Maverick X3 MAX with Smart-Lok Differential (except Turbo RR models 2021 & up)

715005283

\$191.49

- This module allows you to add the Rock Smart Mode to vehicles with the Smart-Lok Differential Kit sold as an accessory or to change to the Rock Smart Mode on vehicles equipped with a standard Smart-Lok.
- The Rock Mode has been specially designed to help cross challenging rocks.
- When high engine torque is detected at low vehicle speed, Smart-Lok will progressively lock the front end and will stay engaged until throttle release to prevent wheel slippage and provide optimal traction.
- The progressive engagement allows for easier steering when maneuvering the vehicle.
- Only one Smart Mode Module can be installed at a time.

## Trail Activ Smart Mode Module

(Not illustrated)

Maverick X3, Maverick X3 MAX with Smart-Lok Differential (except Turbo RR models 2021 & up)

715005284

\$191.49

- This module allows you to add the Trail Activ Smart Mode to vehicles with the Smart-Lok Differential Kit sold as an accessory or to change to the Trail Activ Smart Mode on vehicles equipped with a standard Smart-Lok.
- The Trail Activ mode has been designed for aggressive riding, delivering the ultimate cornering precision.
- When high engine torque and/or an increase in vehicle speed is detected, Smart-Lok will progressively engage the front end and maintain it engaged until throttle release or vehicle speed reduction.
- The progressive engagement allows for smoother and lower steering effort.
- Only one Smart Mode Module can be installed at a time.

## Lonestar Racing Mud Flaps with Brackets



Maverick X3, Maverick X3 MAX

715004865

\$204.99

- These bolt-on mud flaps make a great addition.
- Durable chromoly brackets.
- Protect trailing arms, rotors and CVs from rocks and debris.
- Sold in pairs.
- Incompatible with HMWPE Front A-Arm and Trailing Arm Protector (715002905 and 715003552).

## Lonestar Racing Heavy-Duty Shift Plate & Knob



Maverick X3, Maverick X3 MAX

715004866

\$164.99

- The shift plate is made from durable stainless steel and bolts into place for a secure fit.
- The kit comes with a billet aluminum Lonestar Racing shift knob.
- Offers improved durability for the performance-oriented driver.

## Lonestar Racing Outer Toe Link Boxed Gussets Roller Fairlead



Maverick X3, Maverick X3 MAX 2021 & prior

715004868

\$154.99

- Protects and strengthens the middle radius rod links from rough riding conditions.
- Includes high-grade steel bolts.

<b>Lonestar Racing Quick Release Clutch Cover Pins</b>	Maverick X3, Maverick X3 MAX	<b>715005045</b>	<b>\$119.99</b>
--	------------------------------	------------------	-----------------



- This kit will allow you to take off your clutch cover in seconds to access the belt tool-lessly.
- Includes 4 stainless steel "quick release" pins with clips and tethers.
- Replaces all clutch cover screws.
- This product affects the clutch cover sealing. It is highly recommended to use this product under dry riding conditions only.

<b>Lonestar Racing Heavy-Duty Rear Boxed Radius Rod Support Plate</b>	Maverick X3, Maverick X3 MAX 2021 & prior	<b>715005046</b>	<b>\$249.99</b>
---	---	------------------	-----------------



- Double-layered radius rod support plate made of high-grade steel.
- Reinforces your rod mounting location on the frame while adding a mean racing look to your vehicle.
- Easy to install.

<b>Yoshimura† Slip-on Exhaust</b>	Maverick X3, Maverick X3 MAX	<b>715002882</b>	<b>\$1,669.99</b>
-----------------------------------	------------------------------	------------------	-------------------



- Developed in collaboration with Yoshimura.
- Made from 304-grade stainless steel with brushed aluminum tip.
- Better sounding, better looking and 19% lighter than stock muffler.
- USDF/USDA approved spark arrester.
- Fuel injection system tuning not required.
- ROHVA and EPA compliant.
- Not EC compliant.

<b>Performance Air Filter by Twin AIR†</b>	Maverick X3, Maverick X3 MAX	<b>715002895</b>	<b>\$116.49</b>
--	------------------------------	------------------	-----------------



- The best choice for the harshest conditions.
- Multiple staged oiled filtering foam for superior dust retaining capacity with high airflow.
- Washable and reusable.

<b>Snorkel Pre-Filter</b>	Maverick X3, Maverick X3 MAX (with Snorkel Kit)	<b>715005599</b>	<b>\$132.49</b>
---------------------------	---	------------------	-----------------



- Pre-filter specifically for snorkels.
- Adds extra protection to your engine in harsh riding conditions.
- Helps keep air filter cleaner.
- Filter blocks particles larger than 0.005" (0.13 mm).
- Necessary to maintain vehicle warranty when tracks are installed.

<b>Snorkel Kit</b>	Maverick X3, Maverick X3 MAX (2019 and prior)	<b>715003733</b>	<b>\$953.99</b>
	Maverick X3, Maverick X3 MAX (2020 & up)	<b>715007110</b>	<b>\$926.49</b>



- Raises point of engine and CVT air intakes so vehicle can be semi-submersed in water or mud without the engine taking in water.
- Not compatible with S&B Particle Separator, LinQ Pivoting Rack, Lonestar Racing Rear Intrusion Bar or any rear panels or windows.
- Sealed Air Box 707800780 (sold separately) is required for installation on models manufactured before January 1, 2018.
- Standard on Maverick X3 X mr models.
- Not EC-compliant.
- No fit on all models equipped with remote shock reservoir mounted on C-pillar.

<b>Radiator Relocator</b>	Maverick X3, Maverick X3 MAX	<b>715004937</b>	<b>\$1,433.49</b>
---------------------------	------------------------------	------------------	-------------------



- Relocates stock radiator to rear of cage.
- Protects it from debris and rocks.
- Prevents cooling performance loss in muddy conditions.
- Reduces hot air in the cabin.
- Easy to clean.
- Includes support hardware and hoses.
- Not compatible with any bed accessories, Rear Cage mounted accessories, Complete MTX Audio system and Upper Soft Doors (except LinQ 8 gal [30 L] Cooler Box).
- Radiator (709200703) is required for installation on 2017 models.
- Not compatible with full windshield.

<b>850 W Magneto Kit</b>	Maverick X3, Maverick X3 MAX (2021 & up)	<b>715006279</b>	<b>\$798.49</b>
--------------------------	--	------------------	-----------------



- Increases the magneto output to 850 W.
- Includes rotor, stator and regulator.

WARNING: Any modifications or addition of accessories may affect the handling of your vehicle. It is important to take the time to get familiar with the vehicle once modifications are made to understand how to adapt your driving behavior accordingly. Do not tamper with unauthorized modifications or install equipment not specifically certified by BRP for the vehicle. These modifications have not been tested by BRP and they may increase the risk of injury or loss of control, or render the vehicle illegal to ride. Ask your authorized BRP dealer for suitable available accessories for your vehicle.

## EMERGENCY ACCESSORIES

### Lonestar Racing Fire Extinguisher Support

Maverick X3, Maverick X3 MAX

715007320

\$229.99



- Quick-release support that lets riders slide the fire extinguisher out in a matter of seconds in an emergency.
- Made of billet anodized black aluminum.
- Fits 1.85" (4.7 cm) tubing.
- Can be fixed anywhere on the cage.
- Provides riders with the safety and security of knowing they have dependable emergency equipment on board.
- Comes with both billet mounts, quick-pull pin, mounting plate and two clamps.
- Fire extinguisher sold separately.
- "Lonestar Racing for Can-Am" branded.

### Fire Extinguisher

295100833

\$35.99



- Ideal for grease, oil and electrical fires.
- Fits with Lonestar Racing Fire Extinguisher Support Kit.
- Not EC compliant.

### Emergency Kit

Maverick X3, Maverick X3 MAX

715006102

\$170.49



- Complete emergency kit provides all essential equipment and supplies to get out of most unfavorable situations powersport enthusiasts can find themselves in.
- Includes: jumper cables, air compressor, tire repair kit, ratchet tie-down, duct tape, 3,300 lb (1,500 kg) tow strap, zip-ties, cloth rags.

WARNING: Any modifications or addition of accessories may affect the handling of your vehicle. It is important to take the time to get familiar with the vehicle once modifications are made to understand how to adapt your driving behavior accordingly. Do not tamper with unauthorized modifications or install equipment not specifically certified by BRP for the vehicle. These modifications have not been tested by BRP and they may increase the risk of injury or loss of control, or render the vehicle illegal to ride. Ask your authorized BRP dealer for suitable available accessories for your vehicle.

No traction? No problem. Apache XC Tracks are built for serious terrain. With improved flotation and stability, they tackle deep snow, mud, and everything in between. Engineered for optimized attack angles, reduced noise, and unmatched durability, this system means all-season dominance.

# DESIGNED FOR PEAK PERFORMANCE

Aggressive lugs deliver max traction without sacrificing handling. A reinforced steel frame boosts strength, while the center slide improves alignment and reduces de-tracking. Reduced NVH levels and the wheel placement ensure smooth, quiet power delivery. Plus, wheel longevity is increased with replaceable wheel bearings.



## APACHE TRACK SYSTEMS

### APACHE XC LT

### LIMITED WARRANTY\*

#### Apache XC LT Track System

Maverick X3, Maverick X3 MAX

715007719

\$6,899.99



- Long Track version.
- Brand-new track design to optimize driving off-road and in deep snow conditions .
- Reduction in steering effort thanks to the tandem 4 wheels.
- Vibrations are reduced due to the alignment of the wheels with the rolling band of the track and the shaft damper mounted tandem.
- Better steering precision because of this wheel and track alignment due to good ground contact.
- 1.25" (3.175 cm) lugs in the front and in the back for better traction and lateral stability.
- Track width: front 12.5" and rear 15".
- Adds 3" (7.62 cm) of ground clearance versus 27" tires.
- Additional shaft dampers, tandem dampers, track design and wheel layout significantly reduce NVH (noise vibration harshness).
- Central guide for optimized track alignment and reduced occurrences of detracking.
- Optimized track layout with increased angle of attack for better obstacle crossing and snow performance.
- Stamped and welded steel frame for improved strength and durability.
- Easy maintenance with replaceable hub and wheel bearings.
- Main hub is oil bath with 3 bearings inside for consistent lubrication.
- DPS module and engine and CVT pre-filter required.
- Mounting kit sold separately.

#### NEW Apache XC LT Mounting Kit

Maverick X3, Maverick X3 MAX (64" models)

715008873

\$917.99

Maverick X3, Maverick X3 MAX (72" models)

715008614

\$971.99



- Required for the installation of the Apache XC LT Track System.
- DPS module and Engine Pre-Filter not included.

\*The limited warranty is subject to the exclusions, limitations of liabilities and all other terms and conditions of BRP's standard limited warranty.

## WINTER TRACKS

## LIMITED WARRANTY\*

<b>Apache Backcountry LT Track System</b>	Maverick X3, Maverick X3 MAX	<b>715004734</b>	<b>\$8,549.99</b>
---	------------------------------	------------------	-------------------



- Tracks designed to deliver the best snow performance on the market with unmatched flotation level and traction on snow surface.
- Large contact patch, 37% bigger than the Apache 360 LT.
- Impressive added ground clearance of 7" (18 cm) helps keep the vehicle over the snow.
- Lightweight snowmobile-inspired rail design.
- Aggressive track design with 2" (5 cm) lug height for maximum traction on snow.
- Apache Backcountry LT Mounting Kit, Track DPS Module and Engine and CVT Pre-Filter are required.
- Fine-tune your track system using extra Idler Wheels, Sliders with Vespel Inserts and Rail Ice Scratcher.
- For winter use only.
- Track installation will affect vehicle width and length.

\*The limited warranty is subject to the exclusions, limitations of liabilities and all other terms and conditions of BRP's standard limited warranty.

<b>Apache Backcountry LT Mounting Kit</b> <i>(Not illustrated)</i>	Maverick X3, Maverick X3 MAX	<b>715004397</b> · 64" models	<b>\$841.99</b>
		<b>715004394</b> · 72" models	<b>\$950.49</b>

- Required for installation of the Apache Backcountry Track LT System.
- DPS™ Module and Pre-Filter are required and sold separately.

## APACHE ACCESSORIES

<b>Rail Ice Scratchers</b>	Apache Backcountry LT Track System	<b>860201728</b>	<b>\$127.99</b>
----------------------------	------------------------------------	------------------	-----------------



- Provide additional lubrication in hard and icy conditions.
- Rail mounted, small, light.
- Design expands on coil concept to allow reversing without damage.
- Easily stored when not in use.
- Extends slider life.

<b>Apache Backcountry LT Wheel Kit</b>	Apache Backcountry LT Track System	<b>715006293</b>	<b>\$111.49</b>
--	------------------------------------	------------------	-----------------

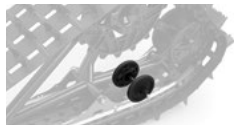

- Additional wheel kit for Backcountry LT rear tracks.
- Reduces drag and rolling resistance in hard snow conditions or when transporting heavier loads.
- Extends slider life in hard snow conditions.
- Includes two wheels, cross shaft and mounting hardware per kit to service one track corner.
- Up to two kits per rear track can be installed.

<b>Sliders with Vespel<sup>†</sup> Inserts</b>	Apache Backcountry LT Track Systems	<b>503194815</b>	<b>\$148.49</b>
--	-------------------------------------	------------------	-----------------



- Use DuPont Vespel inserts for less friction.
- Longer life.
- Can be cut to desired length.
- 8 needed per vehicle.
- Sold individually.

<b>Track DPS Module</b> <i>(Not illustrated)</i>	Maverick X3, Maverick X3 MAX (Turbo RR Engine only)	<b>715006266</b>	<b>\$111.49</b>
	Maverick X3, Maverick X3 MAX (2022 & prior except Turbo RR Engine)	<b>715007338</b>	<b>\$111.49</b>

- Innovative DPS module that ensures speedometer accuracy and optimized steering assist, making for perfect track control and riding ease.
- Required to install the Apache Track Systems.
- See table for fit, compatibility and requirements.

<b>Engine &amp; CVT Air Intake Pre-Filter</b>	Maverick X3, Maverick X3 MAX (except X mr models)	<b>715005600</b>	<b>\$132.49</b>
---	---	------------------	-----------------



- Adds extra protection to your engine in harsh riding conditions.
- Helps keep air filter cleaner.
- Filter blocks particles larger than 0.007" (0.19 mm).
- Easy installation.
- Not compatible with S&B Particle Separator.
- Necessary to maintain vehicle warranty when tracks are installed.

*Required to install the Apache Backcountry LT and Apache 360 LT Track Systems.*

\*The limited warranty is subject to the exclusions, limitations of liabilities and all other terms and conditions of BRP's standard limited warranty.

# APACHE TRACK SYSTEMS FITTING GUIDE

## APACHE BACKCOUNTRY LT

Model Year / Model	Track	Track Mount	Track DPS Module	Pre-filter without Snorkel	Pre-filter with Snorkel
2017 & Up Maverick X3, Maverick X3 MAX (64" Models)	715004734	715004397	715007338 Maverick X3, Maverick X3 Max 2022 & prior (except Turbo RR Engine)	715005600 (except X mr)	715005599
2017 & Up Maverick X3, Maverick X3 MAX (72" Models)		715004394	715006266 Maverick X3, Maverick X3 Max 2023 and up, and 2022 & prior with Turbo RR engines		

## APACHE XC LT

Model Year / Model	Track	Track Mount	Track DPS Module	Pre-filter without Snorkel	Pre-filter with Snorkel
2017 & Up Maverick X3, Maverick X3 MAX (64" Models)	715007719	715008873	715007338 Maverick X3, Maverick X3 Max 2022 & prior (except Turbo RR Engine)	715005600 (except X mr)	715005599
2017 & Up Maverick X3, Maverick X3 MAX (72" Models)		715008614	715006266 All Maverick X3, Maverick X3 Max 2023 and up, and 2022 & prior with Turbo RR engines		

\*The limited warranty is subject to the exclusions, limitations of liabilities and all other terms and conditions of BRP's standard limited warranty.



# BUILD A KIT THAT WORKS HARD.

Combine a mounting kit, push frame, and blade. Then, customize with accessories like the plow angling kit, blade extensions, or edge markers. Easy to install, engineered to last, and tough enough for brutal winter jobs—this lineup covers every plowing need.



## PROMOUNT PLOWS

### ProMount PLOW KITS – REFERENCE CHARTS

	72" Black Steel	72" Flex2
Plow Kit	715008176	715008175
Blade	715009877	715009868
Push Frame	715008116	715008116
Mounting Plate	715008197	715008197

### CAN-AM ProMount STEEL PLOW KITS

<b>Can-Am ProMount Steel 72" (183 cm) Plow Kit</b>	Maverick X3, Maverick X3 MAX	■ 715008176 • Black	<b>\$1,465.97</b>
--	------------------------------	---------------------	-------------------



- These kits include:
  - Can-Am ProMount Steel Blade
  - Push Frame with Quick-Attach System
  - Can-Am ProMount Mounting Plate

## CAN-AM ProMount STEEL BLADES

<b>Can-Am ProMount Steel 72" (183 cm) Blade</b>	Fits ProMount Push Frame	■ 715009877 • Black	<b>\$609.99</b>
---	--------------------------	---------------------	-----------------



- Plow blade made from 12-gauge steel.
- Replaceable wear blade.
- Large pin designed for easy blade rotation to eliminate snow buildup at pivot point.
- Blade design provides best snow roll-off at any angle.
- Clears 66" (168 cm) when plow is fully angled.
- Blade height of 17" (43 cm).
- Compatible with Can-Am ProMount Blade accessories to further enhance plow versatility.
- Not compatible with S3 High Clearance Front A-Arm.

## CAN-AM ProMount ANGLE PLOWS

<b>Can-Am ProMount 72" (183 cm) Steel Oneway State Blade</b>	Fits ProMount Push Frame	715009879	<b>\$705.99</b>
--	--------------------------	-----------	-----------------



- Make the job easier with the right tools, clear long alleys and make the task easier by sending the snow further out of the way.
- Wing end of plow measures 26" (67 cm) high and tapers down to 16" (41 cm).
- One-way "winged" state plow designed to throw snow higher.
- Rubber Flap (715007299) designed to keep snow away from the driver is offered as accessory (sold separately).
- Can-Am branded.

## CAN-AM ProMount FLEX2 PLOW KIT

<b>Can-Am ProMount Flex2 72" (183 cm) Blade</b>	Maverick X3, Maverick X3 MAX	715008175	<b>\$1,540.97</b>
---	------------------------------	-----------	-------------------



- These kits include:
  - Can-Am ProMount Flex2 Blade
  - Push Frame with Quick-Attach System
  - Can-Am ProMount Mounting Plate

## CAN-AM ProMount FLEX2 BLADES

<b>Can-Am ProMount Flex2 72" (183 cm) Blade</b>	Fits ProMount Push Frame	715009868	<b>\$684.99</b>
---	--------------------------	-----------	-----------------



- Plow blade made of UHMWPE, flexible and impact absorbing material prevents damaging your plow when accidental impact occurs.
- Replaceable wear blade.
- Large pin designed for easy blade rotation to eliminate snow buildup at pivot point.
- Blade design provides best snow roll-off at any angle.
- Clears 66" (168 cm) when plow is fully angled.
- Blade height of 17" (43 cm).
- Compatible with Can-Am ProMount Blade accessories to further enhance plow versatility.

## CAN-AM ProMount PLOW ACCESSORIES

<b>Can-Am ProMount Edge Markers</b>	Fits ProMount Plow Blades	715004206	<b>\$48.99</b>
-------------------------------------	---------------------------	-----------	----------------

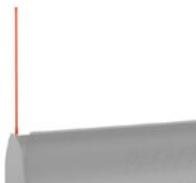

- Help locate the edges of your plow.
- Height: 24" (60 cm).
- Sold in pairs.
- Compatible with Can-Am ProMount Steel and Flex2 Blades with or without Blade Extensions (except for the Can-Am ProMount Steel 54" (137 cm) Blades).

<b>Can-Am ProMount 72" (183 cm) Plastic Wear Blade</b>	Fits ProMount Plow Blades	715004483	<b>\$213.99</b>
--	---------------------------	-----------	-----------------



- Ideal to prevent marks on your driveway.
- Compatible with Can-Am ProMount 72" (183 cm) Blades.

<b>Can-Am ProMount Drift Cutters</b>	Fits ProMount Plow Blades	<b>715006258</b>	<b>\$170.99</b>
--------------------------------------	---------------------------	------------------	-----------------



- Help keep snow in the plow.
- Dimensions: 17" x 13" (43.2 cm x 33 cm).
- Sold in pairs.
- Compatible with Can-Am ProMount Steel and Flex2 blades with or without Blade Extensions (except for the Can-Am ProMount Steel 54" (137 cm) Blades).

<b>Can-Am ProMount Blade Extensions</b>	Fits ProMount Plow Blades	<ul style="list-style-type: none"> <li>■ <b>715004205</b> - Black</li> <li>■ <b>715005319</b> - Yellow</li> </ul>	<b>\$128.49</b>
---	---------------------------	---	-----------------



- These conveniently extend your Can-Am ProMount Blade.
- Add 3" (8 cm) each side.
- Compatible with Can-Am ProMount Blades (except for the Can-Am ProMount Steel 54" (137 cm) Blades).
- Longer wear blade can be installed to go over the extra length given by the extensions.

<b>Back Drag Blade</b> <i>(Not illustrated)</i>	Fits ProMount Plows (60" and more)	<b>715007794</b>	<b>\$299.49</b>
--	------------------------------------	------------------	-----------------

- ¼ thick steel swivel scraper.
- Lifts up when the vehicle is moving forward so as not to affect the scraping.
- Increased capacity to pull snow.
- More aggressive scraping in reverse mode.
- Lifts the scraper off the ground so that it scrapes evenly.
- Adjustable in length for compatibility with 60", 66" and 72" blades.
- Compatible with ProMount blades (Flex and Steel).
- Not compatible with Backcountry Track Kit.

<b>Curved Wear Blade</b> <i>(Not illustrated)</i>	Maverick X3, Maverick X3 MAX	<b>715007793</b> - 72" (183 cm)	<b>\$122.99</b>
--	------------------------------	---------------------------------	-----------------

- Wear blade designed with a folded back bottom lip.
- The increased surface allows for less digging while plowing uneven surfaces.
- Ideal for snow covered gravel, grass, paver stone and other soft surfaces.

## CAN-AM ProMount CUSTOM SOLUTIONS

<b>Can-Am ProMount Push Frame with Quick-Attach System</b>	Maverick X3, Maverick X3 MAX	<b>715008116</b>	<b>\$598.99</b>
--	------------------------------	------------------	-----------------



- Heavy-duty steel tubes designed to withstand the roughest use.
- Mid-mount carriage provides ultimate push strength and traction.
- Designed for maximum plow lift height.
- Features a self aligning quick-attach system, an easy foot release pedal and an ergonomic handle for plow angle adjustment.
- Plow Limit Switch recommended to extend winch cable lifespan.
- Can-Am ProMount Mounting Plate required for installation.
- Blade swivels left or right, 5 positions.
- Large pin designed for easy blade rotation to eliminate dirt and snow buildup at pivot point.
- Plow Roller Fairlead included.

<b>Can-Am ProMount Push Frame Extension</b>	Maverick X3, Maverick X3 MAX	<b>715006257</b>	<b>\$186.99</b>
---	------------------------------	------------------	-----------------



- 12" (30 cm) push frame extension required when plow is installed with Apache Track systems.

<b>Can-Am ProMount Mounting Plate</b>	Maverick X3, Maverick X3 MAX	<b>715008197</b>	<b>\$256.99</b>
---------------------------------------	------------------------------	------------------	-----------------



- Required to install the Can-Am ProMount Push Frame with Quick-Attach System.
- Mounting plate precision designed to stay on year round without compromising ground clearance.
- Comes with the Plow Roller Fairlead.
- Not compatible with S3 High Clearance Front A-Arm.

<b>Can-Am ProMount Plow Angling System</b>	Maverick X3, Maverick X3 MAX	<b>715009241</b>	<b>\$1,182.49</b>
--	------------------------------	------------------	-------------------



- Converts your plow system into an easy-to-control unit from the driver's seat.
- Allows you to have full up/down and left/right plow control at your fingertips with the supplied joystick.
- Using one hand to control all plow motions allows you to easily concentrate and manage your plowing tasks.
- Compatible with the SxS ProMount Push Frame and Blade.
- Not compatible with Apache Backcountry LT Track System.
- Push Frame Extension (715006257) is required for installation with the Front Rancher Bumper.
- Winch and plow sold separately.

<b>NEW</b> Plow Quick Adjust Blade Shoes	ProMount steel & Flex2 Blades 60" (all years), 66"& 72" (2025 & prior)	<b>715009751</b>	<b>\$106.99</b>
--	---	------------------	-----------------



- Zinc-plated steel construction for corrosion resistance.
- Easy and quick tool-free adjustment.
- Pre-set adjustment for different heights.
- Larger shoe diameter for greater ground contact.
- Improved shoe design for better flotation.

<b>ProMount Plow Limit Switch</b>	Maverick X3, Maverick X3 MAX	<b>715006259</b>	<b>\$144.49</b>
-----------------------------------	------------------------------	------------------	-----------------



- For controlling the cable tension when over-raising your plow system.
- Prevents winch, plow push frame and vehicle damage.
- Sensor relocated for optimal lift height.

<b>Plow Roller Fairlead</b>	Maverick X3, Maverick X3 MAX	<b>715001223</b> • Cylindrical Roller Fairlead	<b>\$87.49</b>
-----------------------------	------------------------------	---	----------------



- Larger diameter lower roller reduces wear on wire rope for plow application.
- Can be used with all ProMount plows.

## COVER & TRAILERING

<b>Trailering Cover</b> <i>(Not illustrated)</i>	Maverick X3	<b>715005813</b>	<b>\$436.49</b>
	Maverick X3 MAX	<b>715005814</b>	<b>\$542.99</b>

- Heavy-duty canvas made of UV-resistant solution-dyed polyester.
- Inner soft liner protects windshield and colored panels from abrasion.
- All high-abrasion areas are reinforced with a double canvas layer.
- Weather-resistant trailering cover protects your vehicle during storage and transportation.
- Opening for fuel cap and cabin access on passenger side.
- Quick and easy installation.
- Designed to perfectly fit your vehicle with or without Can-Am accessories.

<b>Bolt-On<sup>†</sup> Retractable Ratcheting Tie-Downs</b>	<b>295101072</b>	<b>\$38.49</b>
---	------------------	----------------



- Perfect for transporting your powersport vehicle or securing loads.
- Mount easily: bolt on any flat surface (e.g., truck bed or frame).
- 1" x 6' (2.5 cm x 1.8 m) tie-down strap with heavy-duty stitching that delivers a 500 lb (226 kg) working load strength and 1,500 lb (680 kg) break strength.
- Convenient retractable push button automatically slackens, spools and stores away strap, while the ratchet mechanism tightens the strap snugly to secure your vehicle or load into place.
- Rubber ratcheting handle provides firm grip, and the hook is vinyl coated to protect whatever surface it hooks into.
- Sold in pairs.

<b>Ratchet Tie-Downs</b>	<b>715008309</b> • Black/Gray	<b>\$31.99</b>
--------------------------	-------------------------------	----------------



- 400 lb (181 kg) safe working load.
- 1" x 10' (2.5 cm x 3 m) strap with Sea-Doo, Ski-Doo and Can-Am logos.
- Deluxe ratchet with rubber handle.
- Coated S hooks.
- Pack of 2.

<b>Heavy-Duty Ratchet Tie-Down</b>	<b>715008308</b>	<b>\$47.99</b>
------------------------------------	------------------	----------------



- 1,000 lb (454 kg) safe working load.
- 1.5 in. x 6 in. (38 mm x 1.8 mm) strap with BRP brands.
- Deluxe ratchet with rubber handle.
- Black-coated clip hooks.
- 12" (300 mm) webbing included.
- Pack of two.

# CAN-AM COMMANDER, MAVERICK TRAIL & MAVERICK SPORT



CAN-AM COMMANDER,  
MAVERICK TRAIL  
& MAVERICK SPORT

# COMMANDER, MAVERICK TRAIL & MAVERICK SPORT ACCESSORIES

**MAVERICK TRAIL  
& MAVERICK SPORT  
COMPARATIVE CHARTS** 164

**COMMANDER  
COMPARATIVE CHARTS** 166

**ACCESSORIES** 169

Roofs 169

Soft Cab Enclosure 169

Windshields & Wind Protection 170

Mirrors 172

Doors 173

Seat Accessories 174

Commander Skid Plates 175

Maverick Trail & Maverick Sport  
Skid Plates 176

Bumpers & Guards 177

LinQ: Easy On, Easy Off Cargo 180

Cargo & Storage 187

Racks & Holders 189

Lights 192

Audio & Communication Systems 197

Electrical & Electronic Accessories 198

Winches & Hitches 200

Performance 202

Apache Track Systems 204



ProMount Plows 207

Covers 210

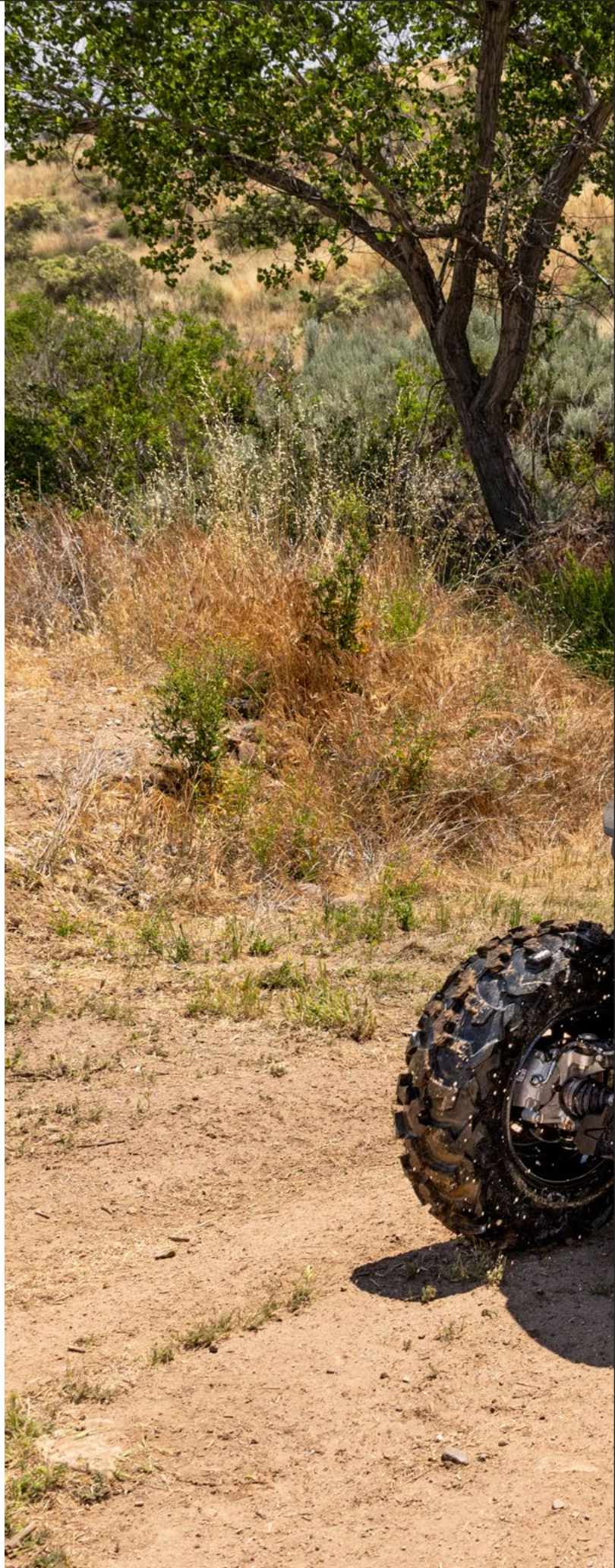
All accessories compatible with  
the Commander are for 2021 and up only.







				
		MAVERICK TRAIL DPS***		MAVERICK SPORT DPS***
COLOR OPTIONS		Triple Black		Triple Black
ENGINES	Type	700 52 hp / 42 lb-ft, Rotax® ACE (Advanced Combustion Efficiency) 650 cc single cylinder, liquid-cooled	1000 75 hp, Rotax® 976 cc, V-twin, liquid-cooled	1000R 100 hp, Rotax® 976 cc, V-twin, liquid-cooled
	Fuel Delivery System	Intelligent Throttle Control (iTC™) with Electronic Fuel Injection (EFI)		Intelligent Throttle Control (iTC™) with Electronic Fuel Injection (EFI)
	Transmission	pDrive primary CVT with engine braking and Electronic Drive Belt Protection L / H / N / R / P	Quick Response System (QRS) CVT with high airflow ventilation and Electronic Drive Belt Protection Extra-L / H / N / R / P	Quick Response System (QRS) CVT with high airflow ventilation and Electronic Drive Belt Protection Extra-L / H / N / R / P
	Drive Train	Selectable 2WD / 4WD with Visco-Lok† QE auto-locking front differential	Selectable 2WD / 4WD auto-locking QE front differential	Selectable 2WD / 4WD auto-locking QE front differential
	Driving Assistance	CVT engine braking SPORT / ECO™ modes		CVT engine braking SPORT / ECO™ modes
	Power Steering	Dynamic Power Steering (DPS™)		Dynamic Power Steering (DPS™)
	SUSPENSIONS	Front Suspension	Double A-arm with sway bar / 10 in. (25.4 cm) suspension travel	
Front Shocks		Twin-tube gas charged shocks		SHOWA 2.0
Rear Suspension		TTA with sway bar / 10.5 in. (26.7 cm) suspension travel		TTA with sway bar / 12 in. (30.5 cm) suspension travel
Rear Shocks		Twin-tube gas charged shocks		SHOWA 2.0
TIRES/ WHEELS	Carlisle ACT 26 x 8/9 x 12 in. 12 in. cast-aluminum		Maxxis Bighorn 2.0 27 x 9/11 x 12 in. 12 in. cast-aluminum	
BRAKES	Dual 220 mm disc brakes with hydraulic twin-piston calipers		Dual 220 mm disc brakes with hydraulic twin-piston calipers	
DIMENSIONS / CAPACITIES	Estimated Dry Weight	1,290 lb (585.5 kg)	1,383 lb (627.7 kg)	1,424 lb (646.3 kg)
	Chassis / Cage	Profiled cage ROPS approved		Profiled cage ROPS approved
	L x W x H	118 x 50 x 69 in. (300.5 x 127 x 175.3 cm)		119 x 60 x 71.1 in. (302.2 x 152.4 x 180.6 cm)
	Wheelbase	90.6 in. (230.1 cm)		90.6 in. (230.1 cm)
	Ground Clearance	10 in. (25.4 cm)		12 in. (30.5 cm)
	Cargo Box Capacity	300 lb (136 kg)		300 lb (136 kg)
	Towing Capacity	1,500 lb (680 kg)		1,500 lb (680 kg)
	Storage Capacity	Total: 5.3 gal (20.2 L)		Total: 5.3 gal (20.2 L)
Fuel Capacity	10 gal (38 L)		10 gal (38 L)	
FEATURES	Gauge	4.5 in. wide digital display		4.5 in. wide digital display
	Instrumentation	DC outlet (10 A)		DC outlet (10 A)
	Magneto	650 W		650 W
	Lighting	Front lighting output 110 W LED taillights		Front lighting output 110 W LED taillights
	Winch	N/A		N/A
	Steering Wheel	Adjustable tilt steering		Adjustable tilt steering
	Protection	Integrated front steel bumper Full heavy-duty HMW plastic skid plate Integrated front steel bumper Half doors Full heavy-duty HMW plastic skid plate		Integrated front steel bumper Premium half doors Full heavy-duty HMW plastic skid plate Mudguards
	Hitch Type	2 in. hitch receiver		2 in. hitch receiver

† Visco-Lok is a trademark of GKN Viscodrive GmbH.

\*Smart-Lok was developed in conjunction with TEAM Industries, a market leader in the drive train industry.



\*\*\*1-year BRP limited warranty. B.E.S.T. term available up to 30 months.

				
	MAVERICK SPORT X RC***	MAVERICK SPORT X MR***	MAVERICK SPORT MAX DPS***	
<b>COLOR OPTIONS</b>	Hybrid White & Legion Red	Hyper Silver	Triple Black	
<b>ENGINES</b>	<b>Type</b>	1000R 100 hp, Rotax® 976 cc, V-twin, liquid-cooled	1000R 100 hp, Rotax® 976 cc, V-twin, liquid-cooled with strategically positioned engine air intake	1000R 100 hp, Rotax® 976 cc, V-twin, liquid-cooled
	<b>Fuel Delivery System</b>	Intelligent Throttle Control (ITC™) with Electronic Fuel Injection (EFI)	Intelligent Throttle Control (ITC™) with Electronic Fuel Injection (EFI)	Intelligent Throttle Control (ITC™) with Electronic Fuel Injection (EFI)
	<b>Transmission</b>	Quick Response System (QRS) CVT with high airflow ventilation and Electronic Drive Belt Protection Extra-L / H / N / R / P	Quick Response System (QRS) CVT with high airflow ventilation. Strategically positioned CVT air intakes and exhaust. Lower gearing ratio and Electronic Drive Belt Protection Extra-L / H / N / R / P	Quick Response System (QRS) CVT with high airflow ventilation and Electronic Drive Belt Protection Extra-L / H / N / R / P
	<b>Drive Train</b>	Lockable front differential with exclusive Smart-Lok™† technology. True 4-mode traction system: 2WD / 4WD with front diff. lock / 4WD ROCK / 4WD TRAIL	Lockable front differential with exclusive Smart-Lok™† technology. True 4-mode traction system: 2WD / 4WD with front diff. lock / 4WD MUD / 4WD TRAIL	Selectable 2WD / 4WD auto-locking QE front differential
	<b>Driving Assistance</b>	CVT engine braking SPORT / ECO™ modes	CVT engine braking SPORT / ECO™ modes	CVT engine braking SPORT / ECO™ modes
	<b>Power Steering</b>	Dynamic Power Steering (DPS™)	Dynamic Power Steering (DPS™)	Dynamic Power Steering (DPS™)
	<b>SUSPENSIONS</b>	<b>Front Suspension</b>	Arched double A-arm with sway bar / 14.8 in. (37.6 cm) suspension travel	Arched double A-arm with sway bar / 14.8 in. (37.6 cm) suspension travel
<b>Front Shocks</b>		FOX® 2.5 PODIUM Piggyback with QS3† compression adjustment	FOX® 2.5 PODIUM Piggyback with QS3† compression adjustment	SHOWA 2.0
<b>Rear Suspension</b>		Arched TTA with sway bar / 14.8 in. (37.6 cm) suspension travel	Arched TTA with sway bar / 14.8 in. (37.6 cm) suspension travel	TTA with sway bar / 12 in. (30.5 cm) suspension travel
<b>Rear Shocks</b>		FOX® 2.5 PODIUM Piggyback with QS3† compression adjustment	FOX® 2.5 PODIUM Piggyback with QS3† compression adjustment	SHOWA 2.0
<b>TIRES / WHEELS</b>	<b>Front/Rear Tires</b> Maxxis Liberty® 30 x 10 x 14 in. 14 in. cast-aluminum	XPS Swamp Force 30 x 9/11 x 14 in. 14 in. cast-aluminum	Maxxis Bighorn 2.0 27 x 9/11 x 12 in. 12 in. cast-aluminum	
<b>BRAKES</b>	<b>Front &amp; Rear</b> Dual 220 mm disc brakes with hydraulic twin-piston calipers	Dual 220 mm disc brakes with hydraulic twin-piston calipers	Dual 220 mm disc brakes with hydraulic twin-piston calipers	
<b>DIMENSIONS / CAPACITIES</b>	<b>Estimated Dry Weight</b>	1,612 lb (731.6 kg)	1,636 lb (742.5 kg)	1,726 lb (782.7 kg)
	<b>Chassis / Cage</b>	Profiled cage ROPS approved	Profiled cage ROPS approved	Profiled cage ROPS approved
	<b>L x W x H</b>	122 x 64 x 74.25 in. (309.8 x 162.6 x 188.6 cm)	122 x 64 x 74.25 in. (309.8 x 162.6 x 188.6 cm)	149 x 60 x 76.2 in. (378.4 x 152.4 x 193.5 cm)
	<b>Wheelbase</b>	90.6 in. (230.1 cm)	90.6 in. (230.1 cm)	120.6 in. (306.3cm)
	<b>Ground Clearance</b>	15 in. (38.1 cm)	15 in. (38.1 cm)	12 in. (30.5 cm)
	<b>Cargo Box Capacity</b>	300 lb (136 kg)	300 lb (136 kg)	300 lb (136 kg)
	<b>Towing Capacity</b>	1,500 lb (680 kg)	1,500 lb (680 kg)	1,500 lb (680 kg)
	<b>Storage Capacity</b>	Total: 5.3 gal (20.2 L)	Total: 5.3 gal (20.2 L)	Total: 6.5 gal (24.7 L)
<b>Fuel Capacity</b>	10 gal (38 L)	10 gal (38 L)	10 gal (38 L)	
<b>FEATURES</b>	<b>Gauge</b>	7.6 in. wide digital display with keypad	7.6 in. wide digital display with keypad	4.5 in. wide digital display
	<b>Instrumentation</b>	DC outlet (10 A)	DC outlet (10 A)	DC outlet (10 A)
	<b>Magneto</b>	650 W	650 W	650 W
	<b>Lighting</b>	Front lighting output 110 W LED signature LED taillights	Front lighting output 110 W LED signature LED taillights	Front lighting output 110 W LED taillights
	<b>Winch</b>	4,500 lb (2,041 kg) winch with synthetic rope	4,500 lb (2,041 kg) winch with synthetic rope	N/A
	<b>Steering Wheel</b>	Adjustable tilt steering	Adjustable tilt steering	Adjustable tilt steering
	<b>Protection</b>	Integrated front steel bumper Rear sport bumper Premium half doors Mudguards Front tow hook Full heavy-duty HMW plastic skid plate UHMWPE rock sliders HMWPE skid plates: Differential, front skid plate, front and rear suspension arm Panoramic mirror Lower front mudflap	Integrated front steel bumper Premium half doors Full heavy-duty HMW plastic skid plate Mudguards Fender flare extensions Front tow hook	Integrated front steel bumper Premium half doors Full heavy-duty HMW plastic skid plate Mudguards
	<b>Hitch Type</b>	2 in. hitch receiver	2 in. hitch receiver	2 in. hitch receiver

†Visco-Lok is a trademark of GKN Viscodrive GmbH.

\*Smart-Lok was developed in conjunction with TEAM Industries, a market leader in the drive train industry.





\*\*\*1-year BRP limited warranty. B.E.S.T. term available up to 30 months.

					
		COMMANDER DPS***		COMMANDER XT***	
COLOR OPTIONS		Compass Green		Fiery Red Triple Black	
ENGINES	Type	700 52 hp / 42 lb-ft, Rotax® ACE (Advanced Combustion Efficiency) 650 cc single cylinder, liquid-cooled	1000R 100 hp, Rotax® 976 cc, V-twin, liquid-cooled	700 52 hp / 42 lb-ft, Rotax® ACE (Advanced Combustion Efficiency) 650 cc single cylinder, liquid-cooled	1000R 100 hp, Rotax® 976 cc, V-twin, liquid-cooled
	Fuel Delivery System	Intelligent Throttle Control (iTC™) with Electronic Fuel Injection (EFI)			
	Transmission	pDrive primary CVT with engine braking and Electronic Drive Belt Protection L / H / N / R / P	Quick Response System (QRS) CVT with high airflow ventilation and Electronic Drive Belt Protection Extra-L / H / N / R / P	pDrive primary CVT with engine braking and Electronic Drive Belt Protection L / H / N / R / P	Quick Response System (QRS) CVT with high airflow ventilation and Electronic Drive Belt Protection Extra-L / H / N / R / P
	Drive Train	Selectable Turf Mode / 2WD / 4WD with Visco-Lok <sup>†</sup> QE auto-locking front differential	Selectable Turf Mode / 2WD / 4WD auto-locking QE front differential	Selectable Turf Mode / 2WD / 4WD with Visco-Lok <sup>†</sup> QE auto-locking front differential	Selectable Turf Mode / 2WD / 4WD auto-locking QE front differential
	Driving Assistance	CVT engine braking SPORT / ECO™ modes			
	Power Steering	Dynamic Power Steering (DPS™)			
	SUSPENSIONS	Front Suspension	Double A-arm with sway bar / 12.5 in. (31.8 cm) suspension travel		Double A-arm with sway bar / 12.5 in. (31.8 cm) suspension travel
Front Shocks		Twin-tube gas charged shocks			
Rear Suspension		TTA with sway bar / 13 in. (33 cm) suspension travel		TTA with sway bar / 13 in. (33 cm) suspension travel	Arched TTA with sway bar / 15 in. (38.1 cm) travel
Rear Shocks		Twin-tube gas charged shocks			
TIRES / WHEELS	Front/Rear Tires	XPS Trail Force 27 x 9/11 x 14 in. 14 in. steel		XPS Trail King 28 x 9/11 x 14 in. 14 in. cast-aluminum	
BRAKES	Front & Rear	Dual 220 mm disc brakes with hydraulic twin-piston calipers		Dual 220 mm disc brakes with hydraulic twin-piston calipers	
	Estimated Dry Weight	1,549 lb (503 kg)	1,619 lb (734.5 kg)	1,594 lb (723.4 kg)	1,694 lb (768.8 kg)
DIMENSIONS / CAPACITIES	Chassis / Cage	Profiled cage ROPS approved		Profiled cage ROPS approved	
	L x W x H	128.5 x 62 x 70.5 in. (326.4 x 157.5 x 180.2 cm)		130 x 62 x 74 in. (330.2 x 157.5 x 188 cm)	130 x 64 x 74 in. (330.2 x 162.6 x 188 cm)
	Wheelbase	90.6 in. (230.1 cm)			
	Ground Clearance	12.5 in. (31.8 cm)		13 in. (33 cm)	
	Cargo Box Dimension	29.5 x 45.2 x 10.6 in. (75.1 x 114.7 x 27 cm)		29.5 x 45.2 x 10.6 in. (75.1 x 114.7 x 27 cm)	
	Cargo Box Capacity	600 lb (272.2 kg)		600 lb (272.2 kg)	
	Towing Capacity	2,000 lb (907.2 kg)		2,000 lb (907.2 kg)	
	Payload Capacity	1,030 lb (467.2 kg)		1,030 lb (467.2 kg)	
	Storage Capacity	Total: 7.3 gal (27.6 L)		Total: 7.3 gal (27.6 L)	
	Fuel Capacity	10 gal (38 L)		10 gal (38 L)	
FEATURES	Gauge	4.5 in. wide digital display		7.6 in. wide digital display with keypad	
	Instrumentation	DC outlet (10 A)		DC outlet (10 A)	
	Anti-theft System	RF Digitally Encoded Security System (D.E.S.S.™) with Start / Stop button		RF Digitally Encoded Security System (D.E.S.S.™) with Start / Stop button	
	Magneto	650 W		650 W	
	Lighting	Front lighting output 110 W LED taillights		Front lighting output 110 W LED signature LED taillights	
	Winch	N/A		4,500 lb (2,041 kg) winch with synthetic cable	
	Steering Wheel	Adjustable tilt steering		Adjustable tilt steering	
	Protection	Premium half doors Full heavy-duty HMW plastic skid plate Mudguards Lower front mudflap		Premium half doors Full heavy-duty HMW plastic skid plate Mudguards XT front bumper Full hard roof Lower front mudflap	
	Hitch Type	2 in. hitch receiver		2 in. hitch receiver	

† Visco-Lok is a trademark of GKN Viscodrive GmbH.

\* Smart-Lok was developed in conjunction with TEAM Industries, a market leader in the drive train industry.





\*\*\*1-year BRP limited warranty. B.E.S.T. term available up to 30 months.

					
	COMMANDER XT-P***	COMMANDER X MR***	COMMANDER MAX DPS***		
<b>COLOR OPTIONS</b>	Mineral Grey & Orange Crush	Dark Wildland Camo	Compass Green		
<b>ENGINES</b>	<b>Type</b>	1000R 100 hp, Rotax® 976 cc, V-twin, liquid-cooled	1000R 100 hp, Rotax® 976 cc, V-twin, liquid-cooled	700 52 hp / 42 lb-ft, Rotax® ACE (Advanced Combustion Efficiency) 650 cc single cylinder, liquid-cooled	1000R 100 hp, Rotax® 976 cc, V-twin, liquid-cooled
	<b>Fuel Delivery System</b>	Intelligent Throttle Control (ITC™) with Electronic Fuel Injection (EFI)	Intelligent Throttle Control (ITC™) with Electronic Fuel Injection (EFI)	Intelligent Throttle Control (ITC™) with Electronic Fuel Injection (EFI)	
	<b>Transmission</b>	Quick Response System (QRS) CVT with high airflow ventilation and Electronic Drive Belt Protection Extra-L / H / N / R / P	Quick Response System (QRS) CVT with high airflow ventilation. Strategically positioned CVT air intakes and exhaust. Lower gearing ratio and Electronic Drive Belt Protection Extra-L / H / N / R / P	pDrive primary CVT with engine braking and Electronic Drive Belt Protection L / H / N / R / P	Quick Response System (QRS) CVT with high airflow ventilation and Electronic Drive Belt Protection Extra-L / H / N / R / P
	<b>Drive Train</b>	Selectable Turf Mode / 2WD / 4WD TRAIL / 4WD TRAIL ACTIV with exclusive Smart-Lok™ was developed in conjunction with TEAM Industries, a market leader in the drive train industry	Lockable front differential with exclusive Smart-Lok™ technology. True 4-mode traction system: 2WD / 4WD with front diff. lock / 4WD MUD / 4WD TRAIL *Smart-Lok™ developed in conjunction with TEAM Industries, a market leader in the drive train industry	Selectable Turf Mode / 2WD / 4WD with Visco-Lok™ QE auto-locking front differential	Selectable Turf Mode / 2WD / 4WD auto-locking QE front differential
	<b>Driving Assistance</b>	CVT engine braking SPORT / ECO™ modes	CVT engine braking SPORT / ECO™ modes	CVT engine braking SPORT / ECO™ modes	
	<b>Power Steering</b>	Dynamic Power Steering (DPS™)	Dynamic Power Steering (DPS™)	Dynamic Power Steering (DPS™)	
	<b>SUSPENSIONS</b>	<b>Front Suspension</b>	Arched double A-arm with sway bar / 14 in. (35.6 cm) suspension travel	Arched double A-arm with sway bar / 14 in. (35.6 cm) suspension travel	Double A-arm with sway bar / 12.5 in. (31.8 cm) suspension travel
<b>Front Shocks</b>		FOX® 2.5 PODIUM Piggyback with QS3® compression adjustment	Twin-tube gas charged shocks	Twin-tube gas charged shocks	
<b>Rear Suspension</b>		Arched TTA with sway bar / 14 in. (35.6 cm) suspension travel	Arched TTA with sway bar / 14 in. (35.6 cm) suspension travel	TTA with sway bar / 13 in. (33 cm) suspension travel	
<b>Rear Shocks</b>		FOX® 2.5 PODIUM Piggyback with QS3® compression adjustment	Twin-tube gas charged shocks	Twin-tube gas charged shocks	
<b>TIRES/ WHEELS</b>	<b>Front/Rear Tires</b> XPS Trac Force 30 x 10 x 15 in. 15 in. cast-aluminum beadlock	<b>Front/Rear Tires</b> XPS Swamp Force 30 x 9/11 x 14 in. 14 in. cast-aluminum	<b>Front/Rear Tires</b> XPS Trail Force 27 x 9/11 x 14 in. 14 in. steel		
<b>BRAKES</b>	<b>Front &amp; Rear</b> Dual 220 mm disc brakes with hydraulic twin-piston calipers	<b>Front &amp; Rear</b> Dual 220 mm disc brakes with hydraulic twin-piston calipers	<b>Front &amp; Rear</b> Dual 220 mm disc brakes with hydraulic twin-piston calipers		
<b>DIMENSIONS / CAPACITIES</b>	<b>Estimated Dry Weight</b>	1,744 lb (791.4 kg)	1,827 lb (829.1 kg)	1,892 lb (860 kg)	1,884 lb (854.4 kg)
	<b>Chassis / Cage</b>	Profiled cage ROPS approved	Profiled cage ROPS approved	Profiled cage ROPS approved	
	<b>L x W x H</b>	130 x 64 x 74.5 in. (330.2 x 162.6 x 189.6 cm)	132 x 64 x 74.2 in. (335.2 x 162.6 x 188.5 cm)	158.3 x 62 x 73 in. (401.8 x 157.5 x 185.4 cm)	
	<b>Wheelbase</b>	90.6 in. (230.1 cm)	90.6 in. (230.1 cm)	120.6 in. (306.3 cm)	
	<b>Ground Clearance</b>	13.5 in. (34.3 cm)	15 in. (38.1 cm)	12.5 in. (31.8 cm)	
	<b>Cargo Box Dimension</b>	29.5 x 45.2 x 10.6 in. (75.1 x 114.7 x 27 cm)	29.5 x 45.2 x 10.6 in. (75.1 x 114.7 x 27 cm)	29.5 x 45.2 x 10.6 in. (75.1 x 114.7 x 27 cm)	
	<b>Cargo Box Capacity</b>	600 lb (272.2 kg)	600 lb (272.2 kg)	600 lb (272.2 kg)	
	<b>Towing Capacity</b>	2,000 lb (907.2 kg)	2,000 lb (907.2 kg)	2,000 lb (907.2 kg)	
	<b>Payload Capacity</b>	1,030 lb (467.2 kg)	1,030 lb (467.2 kg)	1,280 lb (580.6 kg)	
	<b>Storage Capacity</b>	Total: 7.3 gal (27.6 L)	Total: 7.3 gal (27.6 L)	Total: 8.5 gal (32.1 L)	
<b>Fuel Capacity</b>	10 gal (38 L)	10 gal (38 L)	10 gal (38 L)		
<b>FEATURES</b>	<b>Gauge</b>	7.6 in. wide digital display with keypad	7.6 in. wide digital display with keypad	4.5 in. wide digital display	
	<b>Instrumentation</b>	DC outlet (10 A)	DC outlet (10 A)	DC outlet (10 A)	
	<b>Anti-theft System</b>	RF Digitally Encoded Security System (D.E.S.S.™) with Start / Stop button	RF Digitally Encoded Security System (D.E.S.S.™) with Start / Stop button	RF Digitally Encoded Security System (D.E.S.S.™) with Start / Stop button	
	<b>Magneto</b>	650 W	650 W	650 W	
	<b>Lighting</b>	LED headlight LED signature LED taillights	LED headlight LED signature LED taillights	Front lighting output 110 W LED taillights	
	<b>Winch</b>	4,500 lb (2,041 kg) winch with synthetic cable	Relocated 4,500 lb (2,041 kg) winch with synthetic cable and roller fairlead	N/A	
	<b>Steering Wheel</b>	Adjustable tilt steering	Adjustable tilt steering	Adjustable tilt steering	
	<b>Protection</b>	Premium half doors Full heavy-duty HMW plastic skid plate Mudguards XT front bumper Full hard roof	Premium half doors Full heavy-duty HMW plastic skid plate Mudguards / Mudguard extensions Heavy-duty front steel bumper	Premium half doors Full heavy-duty HMW plastic skid plate Mudguards	
	<b>Hitch Type</b>	2 in. hitch receiver	2 in. hitch receiver	2 in. hitch receiver	

† Visco-Lok is a trademark of GKN Viscodrive GmbH.

\* Smart-Lok was developed in conjunction with TEAM Industries, a market leader in the drive train industry.

\*\*\* 1-year BRP limited warranty. B.E.S.T. term available up to 30 months.

					
	<b>COMMANDER MAX XT***</b>		<b>COMMANDER MAX X-P***</b>	<b>COMMANDER MAX X MR***</b>	
<b>COLOR OPTIONS</b>	Fiery Red Triple Black		Mineral Grey & Orange Crush	Dark Wildland Camo	
<b>ENGINES</b>	<b>Type</b>	700 52 hp / 42 lb-ft, Rotax® ACE (Advanced Combustion Efficiency) 650 cc single cylinder, liquid-cooled	1000R 100 hp, Rotax® 976 cc, V-twin, liquid-cooled	1000R 100 hp, Rotax® 976 cc, V-twin, liquid-cooled	
	<b>Fuel Delivery System</b>	Intelligent Throttle Control (iTC™) with Electronic Fuel Injection (EFI)		Intelligent Throttle Control (iTC™) with Electronic Fuel Injection (EFI)	
	<b>Transmission</b>	pDrive primary CVT with engine braking and Electronic Drive Belt Protection L / H / N / R / P	Quick Response System (QRS) CVT with high airflow ventilation and Electronic Drive Belt Protection Extra-L / H / N / R / P	Quick Response System (QRS) CVT with high airflow ventilation and Electronic Drive Belt Protection Extra-L / H / N / R / P	Quick Response System (QRS) CVT with high airflow ventilation. Strategically positioned CVT air intakes and exhaust. Lower gearing ratio and Electronic Drive Belt Protection Extra-L / H / N / R / P
	<b>Drive Train</b>	Selectable Turf Mode / 2WD / 4WD with Visco-Lok® QE auto-locking front differential	Selectable Turf Mode / 2WD / 4WD auto-locking QE front differential	Selectable Turf Mode / 2WD / 4WD TRAIL / 4WD TRAIL ACTIV with exclusive Smart-Lok™**	Lockable front differential with exclusive Smart-Lok™** technology. True 4-mode traction system: 2WD / 4WD with front diff. Lock / 4WD MUD / 4WD TRAIL
	<b>Driving Assistance</b>	CVT engine braking SPORT / ECO™ modes		CVT engine braking SPORT / ECO™ modes	CVT engine braking SPORT / ECO™ modes
	<b>Power Steering</b>	Dynamic Power Steering (DPS™)		Dynamic Power Steering (DPS™)	Dynamic Power Steering (DPS™)
	<b>SUSPENSIONS</b>	<b>Front Suspension</b>	Double A-arm with sway bar / 12.5 in. (31.8 cm) suspension travel	Arched double A-arm with sway bar / 15 in. (38.1 cm) suspension travel	Arched double A-arm with sway bar / 14 in. (35.6 cm) suspension travel
<b>Front Shocks</b>		Twin-tube gas charged shocks		FOX® 2.5 PODIUM Piggyback with QS3 <sup>†</sup> compression adjustment	
<b>Rear Suspension</b>		TTA with sway bar / 13 in. (33 cm) suspension travel	Arched TTA with sway bar / 15 in. (38.1 cm) suspension travel	Arched TTA with sway bar / 14 in. (35.6 cm) suspension travel	Arched TTA with sway bar / 14 in. (35.6 cm) suspension travel
<b>Rear Shocks</b>		Twin-tube gas charged shocks		FOX® 2.5 PODIUM Piggyback with QS3 <sup>†</sup> compression adjustment	Twin-tube gas charged shocks
<b>TIRES/ WHEELS</b>	<b>Front/Rear Tires</b>		XPS Trail King 28 x 9/11 x 14 in. 14 in. cast-aluminum	XPS Trac Force 30 x 10 x 15 in. 15 in. cast-aluminum beadlock	
	<b>Wheels</b>		XPS Trail King 28 x 9/11 x 14 in. 14 in. cast-aluminum	XPS Swamp Force 30 x 9/11 x 14 in. 14 in. cast-aluminum	
<b>BRAKES</b>	<b>Front &amp; Rear</b>		Dual 220 mm disc brakes with hydraulic twin-piston calipers	Dual 220 mm disc brakes with hydraulic twin-piston calipers	
<b>DIMENSIONS / CAPACITIES</b>	<b>Estimated Dry Weight</b>	1,893 lb (865 kg)	1,959 lb (888.4 kg)	2,029 lb (920.2 kg)	
	<b>Chassis / Cage</b>	Profiled cage ROPS approved		Profiled cage ROPS approved	
	<b>L x W x H</b>	160.4 x 64 x 76.2 in. (407.4 x 162.6 x 193.5 cm)		160.4 x 64 x 76.7 in. (407.4 x 162.6 x 194.8 cm)	
	<b>Wheelbase</b>	120.6 in. (306.3 cm)		120.6 in. (306.3 cm)	
	<b>Ground Clearance</b>	13 in. (33 cm)		13.5 in. (34.3 in)	
	<b>Cargo Box Dimension</b>	29.5 x 45.2 x 10.6 in. (75.1 x 114.7 x 27 cm)		29.5 x 45.2 x 10.6 in. (75.1 x 114.7 x 27 cm)	
	<b>Cargo Box Capacity</b>	600 lb (272.2 kg)		600 lb (272.2 kg)	
	<b>Towing Capacity</b>	2,000 lb (907.2 kg)		2,000 lb (907.2 kg)	
	<b>Payload Capacity</b>	1,280 lb (580.6 kg)		1,280 lb (580.6 kg)	
	<b>Storage Capacity</b>	Total: 8.5 gal (32.1 L)		Total: 8.5 gal (32.1 L)	
<b>Fuel Capacity</b>	10 gal (38 L)		10 gal (38 L)	10 gal (38 L)	
<b>FEATURES</b>	<b>Gauge</b>	7.6 in. wide digital display with keypad		7.6 in. wide digital display with keypad	
	<b>Instrumentation</b>	DC outlet (10 A)		DC outlet (10 A)	
	<b>Anti-theft System</b>	RF Digitally Encoded Security System (D.E.S.S.™) with Start / Stop button		RF Digitally Encoded Security System (D.E.S.S.™) with Start / Stop button	
	<b>Magneto</b>	650 W		650 W	
	<b>Lighting</b>	Front lighting output 110 W LED signature LED taillights		LED headlight LED signature LED taillights	
	<b>Winch</b>	4,500 lb (2,041 kg) winch with synthetic cable		4,500 lb (2,041 kg) winch with synthetic cable	
	<b>Steering Wheel</b>	Adjustable tilt steering		Adjustable tilt steering	
	<b>Protection</b>	Premium half doors Full heavy-duty HMW plastic skid plate Mudguards XT front bumper Full roof		Premium half doors Full heavy-duty HMW plastic skid plate Mudguards XT front bumper Full roof	
	<b>Hitch Type</b>	2 in. hitch receiver		2 in. hitch receiver	
		2 in. hitch receiver		2 in. hitch receiver	2 in. hitch receiver

† Visco-Lok is a trademark of GKN Viscodrive GmbH.

\*\*Smart-Lok was developed in conjunction with TEAM Industries, a market leader in the drive train industry.

\*\*\*1-year BRP limited warranty. B.E.S.T. term available up to 30 months.

# ROOFS

	Commander	<b>715007271</b>	<b>\$419.99</b>
	Commander MAX, Maverick Sport MAX	<b>715007272</b>	<b>\$689.99</b>
	Maverick Trail, Maverick Sport	<b>715006218</b>	<b>\$359.99</b>

## Sport Roof



- Robust injection-molded polypropylene construction.
- Excellent protection from the elements.
- Allows installation of lights on top of the roof.
- Compatible with all windshields.

## ProVent Roof Module Kit

Commander, Maverick Trail, Maverick Sport

**715005279**

**\$249.99**



- Provides fresh air in the cab area.
- Optimal performance with full cab enclosure.
- 4 vents provide infinite adjustment of air flow for driver and passenger.
- Filter and pre-filter to limit dust intrusion.
- Easy cleaning of filter and pre-filter.
- Patent pending water management system to keep water out of cabin while maintaining air flow.
- Outer plug closes air intake completely for winter or heavy weather.
- Requires ProVent Roof Module Adapter Kit for Sport Roof.
- Not compatible with roof mounted LED bars, roof racks, roof liners, Bimini Roof, DragonFire Roof or Lonestar Racing Roof.

## ProVent Roof Module Adapter Kit for Sport Roof

*(Not illustrated)*

Commander, Maverick Trail, Maverick Sport

**715005213**

**\$98.99**

- Adapter for fitting ProVent Roof Module Kit onto Commander, Maverick Sport or Maverick Trail Sport Roof.
- Includes roof adapter and hardware.
- Requires ProVent Roof Module Kit (715005279).

## Bimini<sup>†</sup> Roof with Sun Visor

Commander, Maverick Trail, Maverick Sport<sup>†</sup>

**715003661**

**\$382.99**

Commander MAX, Maverick Sport MAX

**715004792**

**\$468.49**



- Heavy-duty canvas made of UV-resistant solution-dyed polyester.
- Soft top comes with a hard visor that allows for storage of rolled-up soft top and mounting auxiliary lights.
- Commander: Also compatible with the Adventure Rack (715006809).

*†Not compatible with Glass Windshield with wiper.*

## Lonestar Racing<sup>†</sup> Aluminum Roof

Commander, Maverick Trail, Maverick Sport<sup>†</sup>

■ **715005137** • Black

**\$609.99**



- Race-true low profile look with integrated front visor for eye-popping performance and protection.
- 0.083" (2.1 mm) thick aluminum roof for durable and lightweight protection from the elements.
- Not compatible with Full Windshields, Rigid Rear Window, Can-Am Intrusion Bars and Overhead Switch Panel.

# SOFT CAB ENCLOSURE

## Soft Cab Enclosure

Maverick Trail

**715003618**

**\$2,179.99**



Includes:

- Sport Roof
- Full Windshield – Hardcoated
- Upper Soft Door Panels
- Soft Rear Panel
- Door Seal Kit

- Requires Trail Half doors on 700 or 800 motorization.
- Not compatible with Sport Half Doors

<b>Soft Cab Enclosure</b>	Commander, Maverick Trail, Maverick Sport (except X mr models)	<b>715004724</b>	N/A
---------------------------	--	------------------	-----



- Can be installed on the Maverick Trail equipped with the Sport Half Doors or on Maverick Sport models.
- Includes:
  - Sport Roof
  - Full Windshield – Hardcoated
  - Upper Soft Door Panels
  - Soft Rear Panel

<b>Soft Cab Enclosure</b>	Commander MAX, Maverick Sport MAX (except X mr models)	<b>715004725</b>	<b>\$3,310.95</b>
---------------------------	--	------------------	-------------------



- Includes:
  - Sport Roof
  - Full Windshield – Hardcoated
  - Upper Soft Door Panels
  - Soft Rear Panel

# WINDSHIELDS & WIND PROTECTION

## WINDSHIELDS

<b>Glass Windshield</b>	Commander, Commander MAX, Maverick Trail, Maverick Sport, Maverick Sport MAX	<b>715003653</b>	<b>\$1,209.99</b>
-------------------------	--	------------------	-------------------



- Curved and laminated glass full windshield in metal frame.
- Provides excellent optical clarity.
- Seals firmly against the cage and protects rider and passenger from the elements.
- Must be used with rear wind protection.
- Not compatible with vehicle with ABS.
- Must be used with windshield wiper to maintain clear visibility during severe riding conditions, such as mud riding.

<b>Glass Windshield with Wiper</b>	Commander, Commander MAX, Maverick Trail, Maverick Sport, Maverick Sport MAX	<b>715003652</b>	<b>\$1,769.99</b>
------------------------------------	--	------------------	-------------------



- Curved and laminated glass full windshield in metal frame.
- Provides excellent optical clarity.
- Seals firmly against the cage and protects rider and passenger from the elements.
- Single-speed wiper with washer fluid dispenser.
- Requires the Overhead Switch Panel (715003669) for installation.
- Must be used with rear wind protection.
- Not compatible with vehicle with ABS.

<b>Half Windshield</b>	Commander, Commander MAX, Maverick Trail, Maverick Sport, Maverick Sport MAX	<input type="checkbox"/> <b>715003657</b> • Clear	<b>\$349.99</b>
		<input checked="" type="checkbox"/> <b>715005280</b> • Tinted	<b>\$359.99</b>



- Formed polycarbonate construction for enhanced rigidity.
- Formulated to be non-yellowing, non-crazing, non-cracking with excellent UV resistance and optical clarity.
- Protects driver and passenger from the elements.
- Features reverse angle lip to deflect air flow.
- Quick and easy tool-less installation or removal.

<b>Full Windshield</b>	Commander, Commander MAX, Maverick Trail, Maverick Sport, Maverick Sport MAX	<b>715003655</b>	<b>\$519.99</b>
------------------------	--	------------------	-----------------



- High-impact-resistant durable polycarbonate full windshield.
- Formed polycarbonate construction for enhanced rigidity.
- Formulated to be non-yellowing, non-crazing, non-cracking with excellent UV resistance and optical clarity.
- Seals firmly against the cage and protects rider and passenger from the elements.
- Must be used with rear wind protection.
- Quick and easy tool-less installation or removal.

<b>Full Windshield – Hardcoated</b>	Commander, Commander MAX, Maverick Trail, Maverick Sport, Maverick Sport MAX	<b>715003656</b>	<b>\$759.99</b>
-------------------------------------	--	------------------	-----------------



- High-impact-resistant Quantum<sup>®</sup> hardcoated polycarbonate full windshield.
- Formed polycarbonate construction for enhanced rigidity.
- Provides excellent optical clarity and better abrasion resistance.
- Seals firmly against the cage and protects rider and passenger from the elements.
- Must be used with rear wind protection.
- Quick and easy tool-less installation or removal.

<b>ProVent Windshield</b>	Commander, Commander MAX, Maverick Trail, Maverick Sport, Maverick Sport MAX	<b>715005210</b>	<b>\$999.99</b>
---------------------------	--	------------------	-----------------



- High-impact-resistant Quantum<sup>®</sup> hardcoated polycarbonate full windshield.
- Controllable vents to manage air flow.
- Channels air into the cabin, defogs windshield, fully closes to eliminate air flow.
- One upper vent and one lower vent with pre-filters.
- Must be used with rear wind protection.
- Provides excellent optical clarity and better abrasion resistance.
- Protects driver and passenger from the elements.
- Quick and easy tool-less installation or removal.
- Not compatible with wiper kits and Wet Sounds Stealth 6 Ultra HD Can-Am Edition Sound Bar.
- Not compatible with the Defrost, Heat and Ventilation System.

<b>PowerFlip Windshield</b>	Commander, Commander MAX, Maverick Trail, Maverick Sport, Maverick Sport MAX	<b>715003658</b>	<b>\$1,269.99</b>
-----------------------------	--	------------------	-------------------



- The PowerFlip Windshield is equipped with electric cylinders that allow the rider to adjust the windshield opening at the touch of a button.
- Windshield is made of hardcoated polycarbonate with a rubber seal contour and a tinted top section.
- Allows you to quickly adapt to changing conditions by adjusting the windshield as you go.
- Can be fully opened for optimal visibility and ventilation, fully closed for maximum protection from the elements, and in between, you have an infinite number of openings.
- Must be used with rear wind protection.

<b>Windshield Wiper and Washer Kit</b>	Commander, Commander MAX, Maverick Trail, Maverick Sport, Maverick Sport MAX	<b>715003654</b>	<b>\$719.99</b>
--	--	------------------	-----------------



- An ideal way to keep your windshield clear in rain, or while riding through mud and water.
- Includes single-speed wiper, washer fluid dispenser and windshield frame mount.
- Must be used with the Glass Windshield (715003653).
- Requires Overhead Switch Panel (715003669) for installation.
- Not compatible with ABS equipped vehicles.

<b>Manual Wiper Kit</b>	Commander, Commander MAX, Maverick Trail, Maverick Sport, Maverick Sport MAX	<b>715009423</b>	<b>\$127.99</b>
-------------------------	---	------------------	-----------------



- Single manual wiper that can be used to clear windshield of debris.
- Easy to install system that requires no electrical hookup.
- Large ergonomic handle provides a good grip over the entire sweeping surface.
- Compatible with glass and hardcoated windshields that use top mounted wipers.

## WIND PROTECTION

<b>Side Wind Deflectors</b>	Commander, Commander MAX, Maverick Trail, Maverick Sport, Maverick Sport MAX	<b>715008632</b>	<b>\$234.49</b>
-----------------------------	--	------------------	-----------------



- Clear polycarbonate air deflectors mount on each side of the cage.
- Can be adjusted at three different positions for cabin air flow control when full windshield is installed:
  - 1) Outside deflection to reduce cabin air flow and turbulence.
  - 2) Inside deflection to increase air flow in the cabin.
  - 3) Windshield ventilation to reduce fog.
- Compatible with all windshields.
- Not compatible with full doors.
- Sold in pairs.

<b>Rear Polycarbonate Window</b>	Commander, Commander MAX, Maverick Trail, Maverick Sport, Maverick Sport MAX (except X mr models)	<b>715010803</b>	<b>\$519.99</b>
----------------------------------	---	------------------	-----------------



- High-impact-resistant polycarbonate window.
- Blocks windshield backdraft or dust and rain from entering for added cabin comfort.
- Sport Roof is required for installation.
- Not compatible with Bimini Roof with Sun Visor, DragonFire Aluminum Roof and Lonestar Racing Aluminum Roof.
- Not compatible on a Commander Max with a Sport Roof Max and Rear Adventure Rack.

<b>Rear Wind Screen</b>	Commander, Commander MAX, Maverick Trail, Maverick Sport, Maverick Sport MAX (except X mr models)	<b>715003664</b>	<b>\$138.49</b>
-------------------------	---	------------------	-----------------



- Full rear mesh screen reduces windshield backdraft for added cabin comfort.
- Installs quickly and easily on roll cage.
- Large Can-Am branding.

<b>Soft Rear Panel</b>	Commander, Commander MAX, Maverick Trail, Maverick Sport, Maverick Sport MAX (except X mr models)	<b>715005887</b>	<b>\$180.99</b>
------------------------	---	------------------	-----------------



- Plastic reinforced and weather-resistant rear panel offers good protection from the elements.
- Made of heavy-duty UV-resistant solution-dyed polyester canvas for excellent resistance to tear and abrasion.
- Clear window made of laminated polished vinyl material.
- Resists cold cracking.
- Installs quickly and easily on roll cage.

# MIRRORS

<b>Side Mirrors</b>	Commander, Commander MAX, Maverick Trail, Maverick Sport, Maverick Sport MAX	<b>715003639</b>	<b>\$265.99</b>
---------------------	--	------------------	-----------------



- Rugged black nylon ½ construction with coated cast-aluminum mount.
- Dual adjustment (horizontal and vertical) will suit any rider.
- Convex optics deliver optimal field of view (FOV).
- Spring-loaded pivots let mirrors fold back completely.
- Sold in pairs.

<b>Panoramic Center Mirror</b>	Commander, Commander MAX, Maverick Trail, Maverick Sport, Maverick Sport MAX	<b>715003638</b>	<b>\$104.99</b>
--------------------------------	--	------------------	-----------------



- Wide-angle convex mirror.
- Offers enhanced visibility.
- Can be used with or without roof or windshield and with cab enclosure.

<b>Sport Panoramic Center Mirror</b>	Commander, Commander MAX, Maverick Trail, Maverick Sport, Maverick Sport MAX	<b>715004924</b>	<b>\$106.49</b>
--------------------------------------	--	------------------	-----------------



- Convex mirror for wide rearward visibility.
- Ball-joint design with tightening knob for steady multi-angle adjustment.
- Can be used with or without roof or windshield.
- Not for road use.

<b>Rear View Mirror and Camera Monitor</b>	Commander, Commander MAX, Maverick Trail, Maverick Sport, Maverick Sport MAX	<b>715009410</b>	<b>\$534.99</b>
--	--	------------------	-----------------



- Fully waterproof rearview mirror and monitor kit.
- See exactly what you need to see with the multiple camera feeds from the rear view camera.
- This unit replaces the stock rearview mirror (the screen is integrated in the unit's replacement rearview mirror).
- The camera uses infrared light for night vision capabilities.

# DOORS

<b>Trail Half Doors</b>	Maverick Trail	<b>715004418</b>	<b>\$702.99</b>
-------------------------	----------------	------------------	-----------------



- Half doors made of molded polypropylene to match vehicle's styling.
- Steel frame for high level of rigidity.
- A must-have for additional cabin comfort.
- Keep the vehicle narrow in tight trail riding conditions.
- Door Trim is required to complete your door kit (sold separately).
- Standard on 1000 Base and 1000 DPS™ models.
- Sold in pairs.

<b>Door Trim</b>	Maverick Trail	<ul style="list-style-type: none"> <li>■ Can-Am Red</li> <li>■ Timeless Black</li> <li>■ Octane Blue</li> </ul>	<table border="1"> <tr> <td>Left</td> <td>Right</td> <td></td> </tr> <tr> <td><b>705012419</b></td> <td><b>705012420</b></td> <td><b>\$189.99</b></td> </tr> <tr> <td><b>705015607</b></td> <td><b>705015613</b></td> <td><b>\$244.99</b></td> </tr> <tr> <td><b>705016447</b></td> <td><b>705016449</b></td> <td><b>\$244.99</b></td> </tr> </table>	Left	Right		<b>705012419</b>	<b>705012420</b>	<b>\$189.99</b>	<b>705015607</b>	<b>705015613</b>	<b>\$244.99</b>	<b>705016447</b>	<b>705016449</b>	<b>\$244.99</b>
Left	Right														
<b>705012419</b>	<b>705012420</b>	<b>\$189.99</b>													
<b>705015607</b>	<b>705015613</b>	<b>\$244.99</b>													
<b>705016447</b>	<b>705016449</b>	<b>\$244.99</b>													



- Matching colored panel for Trail Half Doors.
- Required to complete the Trail Half Doors (sold separately).

<b>Sport Half Doors</b>	Commander, Commander MAX, Maverick Trail, Maverick Sport, Maverick Sport MAX	<b>715006217</b>	<b>\$702.99</b>
-------------------------	--	------------------	-----------------



- Half doors made of molded polypropylene to match vehicle's styling.
- A must-have for additional cabin comfort.
- Features rounded shape to increase cabin space.
- Standard on all Commander & Maverick Sport models.
- Can be installed on Maverick Trail models for additional cabin space.
- Door Trim is required to complete your door kit (sold separately).
- Sold in pairs.

<b>Door Trim</b>	Commander, Commander MAX, Maverick Trail, Maverick Sport, Maverick Sport MAX	<ul style="list-style-type: none"> <li>■ Can-Am Red</li> <li>■ Timeless Black</li> <li>■ Octane Blue</li> </ul>	<table border="1"> <tr> <td>Left</td> <td>Right</td> <td></td> </tr> <tr> <td><b>705015464</b></td> <td><b>705015465</b></td> <td><b>\$189.99</b></td> </tr> <tr> <td><b>705015608</b></td> <td><b>705015615</b></td> <td><b>\$254.99</b></td> </tr> <tr> <td><b>705016448</b></td> <td><b>705016450</b></td> <td><b>\$254.99</b></td> </tr> </table>	Left	Right		<b>705015464</b>	<b>705015465</b>	<b>\$189.99</b>	<b>705015608</b>	<b>705015615</b>	<b>\$254.99</b>	<b>705016448</b>	<b>705016450</b>	<b>\$254.99</b>
Left	Right														
<b>705015464</b>	<b>705015465</b>	<b>\$189.99</b>													
<b>705015608</b>	<b>705015615</b>	<b>\$254.99</b>													
<b>705016448</b>	<b>705016450</b>	<b>\$254.99</b>													



- Matching colored panel for the Sport Half Doors.
- Required to complete the Sport Half Doors (sold separately).
- Sold in pairs.

<b>Upper Soft Door Panels</b>	Commander, Commander MAX, Maverick Trail, Maverick Sport, Maverick Sport MAX	<table border="1"> <tr> <td><b>715004718</b> - Front</td> <td></td> </tr> <tr> <td><b>715004726</b> - Rear</td> <td></td> </tr> </table>	<b>715004718</b> - Front		<b>715004726</b> - Rear		<b>\$839.99</b>
<b>715004718</b> - Front							
<b>715004726</b> - Rear							



- Upper canvas portion of the doors with sturdy steel frame.
- Seals firmly against the cage and protects rider and passenger from the elements.
- Converts half door into full door for a complete cab enclosure.
- Zippered window made of laminated polished vinyl material for added ventilation.
- Easy to remove on hot and sunny days.
- Sport Roof required for installation.
- Can be installed on the Maverick Trail equipped with the Sport Half Doors (715006217) or with the standard half doors on Maverick Sport models.

*†Not compatible with Trail Half Doors or with the standard half doors on Maverick Trail models.*

<b>Upper Soft Door Panels</b> <i>(Not illustrated)</i>	Maverick Trail	<b>715003620</b>	<b>\$839.99</b>
---	----------------	------------------	-----------------

- Can only be installed with Trail Half Doors or with the standard half doors on Maverick Trail models.
- Not compatible with Sport Half Doors or with the standard half doors on Maverick Sport models.
- Sport Roof required for installation.

<b>Door Seal Kit</b> <i>(Not illustrated)</i>	Maverick Trail	<b>715004773</b>	<b>\$41.99</b>
--	----------------	------------------	----------------

- Improves door sealing from the elements and provides additional cabin comfort.
- Included in the Soft Cab Enclosure Kit (715003618).
- Not compatible with Sport Half Doors.
- Compatible with the Trail Half Doors or with the stock doors on the Maverick Trail.

<b>Door Knee Pads with Storage</b>	Maverick Trail	<b>715003635</b>	N/A
------------------------------------	----------------	------------------	-----



- Padded door cushion with integrated pocket for storage.
- Protect driver's and passenger's legs from direct contact with the doors while riding.
- Increase cabin comfort.
- Require Trail Half Door on 800 Base and 800 DPS models (715004418).
- Offer storage space for small items.
- Sold in pairs.
- Not compatible with Sport Half Doors.

<b>Door Storage with Padding</b>	Commander, Commander MAX, Maverick Trail, Maverick Sport, Maverick Sport MAX	<b>715004914</b>	<b>\$191.49</b>
----------------------------------	--	------------------	-----------------



- Weather-resistant door storage bags with integrated padding.
- Holds your gear safely and securely and also protects driver's and passenger's legs from direct contact with the doors while riding.
- Each bag is designed as a 0.5 gal (2 L) capacity pocket also equipped with inner netting compartments.
- Semi-rigid construction renders them flexible enough to fit odd-shaped loads.
- Easy to install.
- Sold in pairs.
- Bags attach on stock doors of the Maverick Sport or on the Maverick Trail equipped with the Sport Half Doors (715006217).
- Not compatible with stock doors on the Maverick Trail or the Trail Half Doors.

## SEAT ACCESSORIES

<b>4-Point Harness</b>	Commander, Maverick Trail, Maverick Sport,	<b>715008035</b> • Driver	<b>\$304.99</b>
		<b>715008036</b> • Passenger	<b>\$256.99</b>



- Exclusive controlled decelerator technology (patent pending) absorbs additional energy in case of an accident.
- Designed to offer maximum riding comfort.
- Easy one-click latch and release.
- Not EC compliant.
- ROHVA compliant.

<b>Seat Belt Shoulder Pads</b>	Commander, Commander MAX, Maverick Trail, Maverick Sport, Maverick Sport MAX	<b>715002894</b>	<b>\$48.99</b>
--------------------------------	--	------------------	----------------



- Provide additional riding comfort by preventing seat belt from rubbing on neck and shoulder.
- Fit with stock 3-point seat belts and 4 point harness.
- Easy Velcro installation.
- Can-Am branded.
- Sold in pairs for driver and passenger.

# COMMANDER SKID PLATES

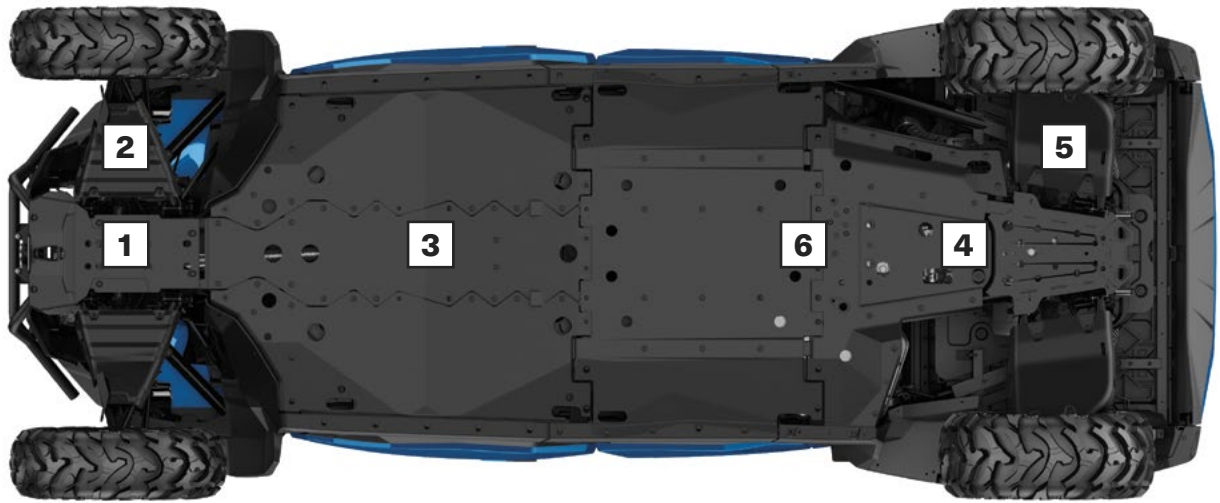

Our plastic plates glide smoothly and silently over obstacles, offering great protection in rough terrain.

- Made of abrasion-resistant thermoformed High Molecular Weight Polyethylene (HMWPE).
- Lighter than aluminum.
- Superior stress crack resistance.
- High impact strength.
- Ultra-sturdy 3/8" (10 mm) thickness.

## COMMANDER, COMMANDER MAX

Offer your Commander the full protection kit or get parts individually		DPS & XT 700	XT 1000, XT-P & X mr
<b>HMWPE SKID PLATE PROTECTION KIT</b>			
Includes:			
- HMWPE Front Skid Plate.		<b>715006349</b> (except MAX)	<b>715006350</b> (except MAX)
- HMWPE Front A-Arm Protectors.			
- HMWPE Rear Skid Plate.			
- HMWPE Rear A-Arm Protectors.			
- HMWPE Underbelly Plates.		<b>715006351</b> (MAX only)	<b>715007303</b> (MAX only)
- HMWPE Central Skid Plate.			
<b>INDIVIDUAL HMWPE SKID PLATES</b>			
<b>1</b>	<b>HMWPE Front Skid Plate</b>	<b>715008279</b>	<b>715008279</b>
<b>2</b>	<b>HMWPE Front A-Arm Protectors</b>	<b>715008276</b>	<b>715008277</b>
<b>3</b>	<b>HMWPE Underbelly Plates</b> Keep the rollover clearance.	<b>715006273</b>	<b>715006273</b>
<b>4</b>	<b>HMWPE Rear Skid Plate</b>	<b>715007302</b>	<b>715007302</b>
<b>5</b>	<b>HMWPE Rear A-Arm Protectors</b>	<b>715004271</b>	<b>715006341</b>
<b>6</b>	<b>HMWPE Central Skid Plate</b> Provides center protection for MAX models.	<b>715004272</b> (MAX only)	<b>715004272</b> (MAX only)

# MAVERICK TRAIL & MAVERICK SPORT SKID PLATES

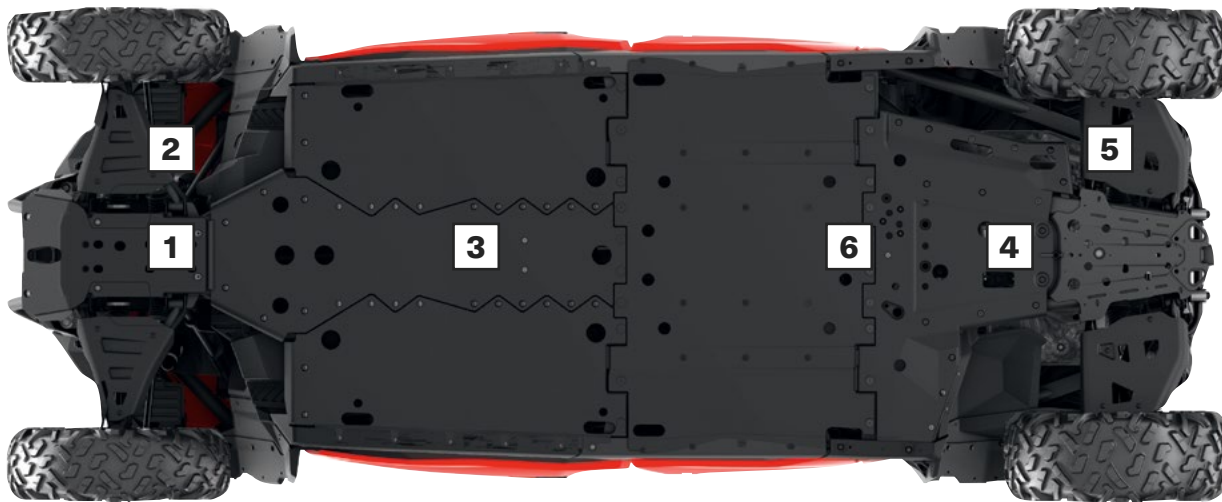

Our plastic plates glide smoothly and silently over obstacles, offering great protection in rough terrain.

- Made of abrasion-resistant thermoformed High Molecular Weight Polyethylene (HMWPE).
- Lighter than aluminum.
- Superior stress crack resistance.
- High impact strength.
- Ultra-sturdy 3/8" (10 mm) thickness.

## MAVERICK SPORT & MAVERICK SPORT MAX

## MAVERICK TRAIL

Offer your Maverick the full protection kit or get parts individually	2019 Base & DPS	2019 X mr	2020 & Up Base & DPS	2020 & Up X mr & X xc	Any Year X rc	
<b>HMWPE SKID PLATE PROTECTION KIT</b>						
Includes:						
- HMWPE Front Skid Plate.	715006348 (except MAX)		715006349 (except MAX)			715006346 (2019 & prior)
- HMWPE Front A-Arm Protectors.		715006353		715006350	—	
- HMWPE Rear Skid Plate.						
- HMWPE Rear A-Arm Protectors.						
- HMWPE Underbelly Plates.	715006352 (MAX only)		715006351 (MAX only)			715006347 (2020 & up)
- HMWPE Central Skid Plate.						
<b>INDIVIDUAL HMWPE SKID PLATES</b>						
<b>1</b> HMWPE Front Skid Plate	715008279	715008279	715008279	715008279	(Standard on X rc models)	715008279
<b>2</b> HMWPE Front A-Arm Protectors	715008276	715008277	715008276	715008277	(Standard on X rc models)	715008278
<b>3</b> HMWPE Underbelly Plates Keep the rollover clearance.	715006339	715006339	715006273	715006273	715006339 (2019)	715006339 (2019 & prior)
					715006273 (2020 & up)	715006273 (2020 & up)
<b>4</b> HMWPE Rear Skid Plate	715007302	715007302	715007302	715007302	715007302	715007302
<b>5</b> HMWPE Rear A-Arm Protectors	715004271	715006341	715004271	715006341	(Standard on X rc models)	715003699
<b>6</b> HMWPE Central Skid Plate Provides center protection for MAX models.	715004272 (MAX only)	—	715004272 (MAX only)	—	—	—

# BUMPERS & GUARDS

## COMMANDER BUMPERS

<b>X mr Front Bumper</b>	Commander, Commander MAX	<b>715007248</b> · Black	<b>\$372.49</b>
--------------------------	--------------------------	--------------------------	-----------------



- Heavy-duty 1.5" (3.8 cm) diameter steel-tube construction.
- Inside and outside anti-corrosion coating with durable finish.
- Provides additional front body protection.
- Integrated winch support plate for winch relocation at a higher position for easier access in muddy conditions or for auxiliary lights.
- Allows the installation of front corner protectors.
- Winch not included.

<b>Front Bumper</b>	Commander, Commander MAX	<b>715007631</b>	<b>\$399.99</b>
---------------------	--------------------------	------------------	-----------------



- Made of 1.5" (3.8 cm) diameter steel tubing with durable powder-coat finish.
- Includes integrated mount points for seamless light installation.
- Compatible with synthetic and steel rope winches and Hawse fairlead.
- Not EC compliant.

<b>Front Corner Protectors</b>	Commander, Commander MAX	<b>715006807</b>	<b>\$212.99</b>
--------------------------------	--------------------------	------------------	-----------------



- Heavy-duty 1.5" (3.8 cm) diameter steel tubing.
- Inside and outside anti-corrosion coating with durable powder-coat finish.
- Provide additional protection for vehicle's front corners.
- Requires stock XT, XT-P or X mr bumper.
- Sold in pairs.
- Not EC compliant.

<b>Rear Bumpers</b>	Commander, Commander MAX	<b>715006808</b>	<b>\$308.49</b>
---------------------	--------------------------	------------------	-----------------



- Rear bumper made of heavy-duty 1.5" (3.8 cm) diameter steel tubing.
- Protect vehicle bodywork and exhaust system.
- Inside and outside anti-corrosion coating with durable powder-coat finish.
- Compatible with Mud Flaps.
- Not EC compliant.

<b>Mud Flaps</b>	Commander, Commander MAX	<b>715003041</b>	<b>\$170.49</b>
------------------	--------------------------	------------------	-----------------



- Keep mud and debris out of cargo area and protect trailer or vehicles behind you.
- Add aesthetic appeal to your vehicle.
- Made of EPDM rubber.
- Require Rear Bumper for installation.
- Sold in pairs.

## MAVERICK TRAIL & MAVERICK SPORT BUMPERS

<b>Front Trail Bumper</b>	Maverick Trail, Maverick Sport, Maverick Sport MAX	<span style="color: black;">■ 715003680</span> · Black <span style="color: yellow;">■ 715003681</span> · Sunburst Yellow	<b>\$329.99</b>
---------------------------	--	---	-----------------



- Front bumper made of heavy-duty 1.5" (3.8 cm) diameter steel tubing.
- Completes the stock bumper for more front coverage and essential vehicle protection for trail riders.
- Inside and outside anti-corrosion coating with durable powder coat finish.
- Includes integrated mount points for seamless light installation.

<b>Rear Trail Bumper</b>	Maverick Trail, Maverick Sport, Maverick Sport MAX	<span style="color: black;">■ 715007109</span> · Black	<b>\$329.99</b>
--------------------------	--	--	-----------------



- Rear bumper made of heavy-duty 1.5" (3.8 cm) diameter steel tubing.
- Protects vehicle bodywork and exhaust system.
- Inside and outside anti-corrosion coating with durable powder coat finish.

<b>Front Corner Protectors</b>	Maverick Trail, Maverick Sport, Maverick Sport MAX	■ <b>715004912</b> · Black	<b>\$159.49</b>
--------------------------------	--	----------------------------	-----------------



- Heavy-duty 1.5" (3.8 cm) diameter steel tubing.
- Inside and outside anti-corrosion coating with durable powder coat finish.
- Provide additional protection for vehicle's front corners.
- Require Front Trail Bumper (715003680 / 715003681) for installation.
- Sold in pairs.

<b>Rancher Rear Bumper</b>	Maverick Trail, Maverick Sport, Maverick Sport MAX	<b>715004304</b>	<b>\$446.99</b>
----------------------------	--	------------------	-----------------



- Heavy-duty protection made of 1.5" (3.8 cm) diameter steel tubing, perfect for farm, ranch and forestry applications.
- Inside and outside anti-corrosion coating with durable powder coat finish.
- Offers full rear coverage with integrated tail light protectors.
- Not EC compliant.

## ROCK SLIDERS

<b>Rock Sliders</b>	Commander, Maverick Trail, Maverick Sport (except X rc) (2025 & prior)	■ <b>715003689</b> · Black	<b>\$457.99</b>
	Commander MAX, Maverick Sport MAX (2025 & prior)	■ <b>715004754</b> · Black	<b>\$585.99</b>



- Made of heavy-duty 1.5" (3.8 cm) diameter steel tubing.
- Inside and outside anti-corrosion coating with durable powder coat finish.
- Protect vehicle's rocker panels and undercarriage against large obstacles.
- Sold in pairs.

## INTRUSION BARS

<b>Front Intrusion Bar</b>	Commander, Commander MAX, Maverick Trail, Maverick Sport, Maverick Sport MAX	<b>715003872</b>	<b>\$404.49</b>
----------------------------	--	------------------	-----------------



- Steel intrusion bar matches perfectly with vehicle's styling.
- Inside and outside anti-corrosion coating with durable powder coat finish.
- Provides additional protection by preventing large objects from entering the driver/passenger area.
- Tube design reduces obstructed lines of sight and blind spots for better visibility.
- Not compatible with windshields and Soft Door Panels.

<b>Lonestar Racing Rear Intrusion Bar</b>	Maverick Trail, Maverick Sport	■ <b>715005134</b> · Black	<b>\$489.99</b>
		■ <b>715004874</b> · Can-Am Red	<b>\$479.99</b>



- Race-engineered to Lonestar Racing's trademark standards for toughness, these stylishly crafted accessories will also enhance your vehicle with visual impact.
- Made of 1.5" (3.8 cm) diameter steel tubing with durable powder coat finish.
- Provides additional protection for driver and passenger.
- Not compatible with the Sport Roof, rear panels and windows, All-Terrain Trunk Cover.
- Not compatible with X mr models or with the Snorkel Kit.
- Not compatible with S&B particle separator.

## FENDER FLARES

<b>Fender Flares</b>	Commander, Commander MAX	<b>715006814</b>	<b>\$223.49</b>
----------------------	--------------------------	------------------	-----------------



- Fender flares made from injection-molded polypropylene.
- Keep mud and debris out of vehicle.
- Designed for quick and easy installation.
- Front and rear extensions and mounting hardware included.
- Increase vehicle's overall width by 3" (8 cm) when installed on Commander and Commander MAX models.

<b>2" (51 mm) Fender Flares</b>	Maverick Trail	<b>715004958</b>	<b>\$279.99</b>
---------------------------------	----------------	------------------	-----------------



- Extended fender flares made from injection-molded polypropylene.
- Keep mud and debris out of vehicle.
- Designed for quick and easy installation.
- Include front and rear extensions, mounting hardware and Fender Flare Rear Extensions (715004404).
- Increase vehicle's overall width by 3.5" (8.9 cm).

<b>3" (76 mm) Fender Flares</b>	Maverick Trail, Maverick Sport, Maverick Sport MAX	<b>715004959</b>	<b>\$255.49</b>
---------------------------------	--	------------------	-----------------



- Fender flares made from injection-molded polypropylene.
- Keep mud and debris out of vehicle.
- Designed for quick and easy installation.
- Include front and rear extensions and mounting hardware.
- Increase vehicle's overall width by 6" (15.3 cm) when installed on Maverick Trail models.

<b>Fender Flare Rear Extensions</b>	Maverick Trail, Maverick Sport, Maverick Sport MAX	<b>715004462</b>	<b>\$279.99</b>
-------------------------------------	--	------------------	-----------------



- Block terrain debris from kicking up onto you as you ride or damaging your vehicle thanks to these extra-large Fender Flare Extensions, which also include Rear Fender Flare Extensions (715004404) for added protection from mud/snow, especially when riding with track kits.
- Made from injection-molded polypropylene for best fit and finish.
- Not compatible with 2" (51 mm) Fender Flares.
- Include front and rear extensions.
- For Maverick Trail, must be used with 3" (76 mm) Fender Flares (715004959).
- Standard on Maverick Sport X mr models.

## OTHERS

<b>License Plate Holder</b>	Maverick Trail, Maverick Sport, Maverick Sport MAX	<b>715007006</b>	<b>\$122.99</b>
-----------------------------	--	------------------	-----------------



- Supports your license plate on the Rear Trail Bumper.
- Plate lights can be relocated on bumper to light up license plate.
- Require Rear Trail Bumper (715007109) for installation.
- EC compliant.

<b>Tail Light Protectors</b>	Maverick Trail, Maverick Sport, Maverick Sport MAX	<b>715003692</b>	<b>\$116.99</b>
------------------------------	--	------------------	-----------------



- Anti-corrosion coating with durable powder coat finish.
- Rugged style, aggressive look.
- Sold in pairs.
- Not EC compliant.

<b>Radiator Protector</b>	Maverick Trail, Maverick Sport, Maverick Sport MAX	<b>715003700</b>	<b>\$116.99</b>
---------------------------	--	------------------	-----------------

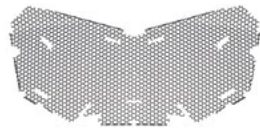

- Perforated steel shield mounted over the radiator face, providing protection from stones and branches.
- Not recommended for winter use.

# LINQ: EASY ON, EASY OFF CARGO

## COMMANDER'S LINQ ACCESSORIES

### MOUNTING LOCATION AND REQUIREMENTS

<ul style="list-style-type: none"> <li>No tools needed: Quickly install and remove accessories by hand.</li> <li>Equip your Can-Am for specialized tasks in no time.</li> <li>Sturdy mounting system that holds up to the roughest terrain.</li> </ul>	Vehicle Standard Cargo Box	LinQ® Cargo Rack 715006815	Adventure Roof Rack 715004095	Deluxe Headache Rack 715006823	Rear Adventure Rack 715006809	Passenger Seat Base
<b>LinQ ACCESSORIES WITH 16" BASE</b>		LinQ anchors mounted 16 inches apart, center-to-center. Lower loading capacity than the LinQ with 36" base accessories. Can be used on Can-Am ATV and SxS vehicles, Can-Am Spyder and Ryker vehicles, Sea-Doo watercraft and Ski-Doo snowmobiles.				
<b>NEW LinQ 5 US Gal (20 L) Fuel Caddy</b> 715007822		No compatibility	No compatibility	No compatibility	No compatibility	LinQ Base Installation Kit 715008125
<b>NEW LinQ Rigid Cooler 4.7 US Gal (18 L)</b> 715010491		LinQ Base Installation Kit 715008125	LinQ Base Installation Kit 715008125	LinQ Base Installation Kit 715008125	LinQ Base Installation Kit 715008125	No compatibility
<b>NEW LinQ Cooler 5.3 US Gal (20 L)</b> 295101257 • Gray		No compatibility	No compatibility	No compatibility	No compatibility	
<b>LinQ 11.4 US Gal (43 L) Cooler</b> 715007825 • Black 715009276 • Gray		No compatibility	No compatibility	No compatibility	No compatibility	
<b>LinQ 4.2 Gal Cooler</b> 295100698 • White 219400964 • Black						
<b>LinQ Tool Kit</b> 715006829						
<b>LinQ Tool Box</b> 715008111	LinQ Base Installation Kit 715008125					
<b>LinQ SR 5.5 Gal (21 L) Bag</b> 860202449						
<b>LinQ 4.5 Gal (17 L) Sport Bag</b> 860202447		LinQ Base Installation Kit 715008125	LinQ Base Installation Kit 715008125	LinQ Base Installation Kit 715008125	LinQ Base Installation Kit 715008125	Passenger Seat LinQ Anchor Kit 715003951
<b>LinQ Modular Box</b> 715005494 • (10 L) 715007112 • (20 L) 715006830 • (30 L)						
<b>LinQ Roll-Top Bag</b> 715008110						
<b>LinQ 26 US Gal (100 L) Explorer Bag</b> 295101016						
<b>LinQ 5.3 US Gal (20 L) Semi-Rigid Cooler</b> 295101252						
<b>LinQ ACCESSORIES WITH 36" BASE</b>		Mount on LinQ racks often used by Can-Am ORV vehicles. Higher loading capacity than the LinQ with 16" base accessories. Usage is limited to Can-Am ORV vehicles.				
<b>LinQ 12 Gal (45 L) Cargo Box</b> 715003879						
<b>LinQ 23 Gal (86 L) Trunk Box</b> 715004923						
<b>LinQ Cooler</b> 715004778 • Black	No compatibility	No further requirements	No compatibility	No compatibility	No compatibility	No compatibility
<b>LinQ OGIO<sup>+</sup> Bag</b> 715002923 • Black						
<b>LinQ Heavy Duty Basket</b> 715001215						
<b>LinQ Low Profile Basket</b> 715004282						
<b>LinQ HOLDERS</b>						
<b>LinQ Gear Grips</b> 715005340	No further requirements	No further requirements	Side wall installation LinQ Adapters 715003058	Side wall installation LinQ Adapters 715003058	Side wall installation LinQ Adapters 715003058	Passenger Seat LinQ Anchor Kit 715003951
<b>LinQ Tool Holder</b> 715007358						

# MAVERICK'S LINQ ACCESSORIES

## MOUNTING LOCATION AND REQUIREMENTS

<ul style="list-style-type: none"> <li>No tools needed: Quickly install and remove accessories by hand.</li> <li>Equip your Can-Am for specialized tasks in no time.</li> <li>Sturdy mounting system that holds up to the roughest terrain.</li> </ul>	Vehicle Standard Cargo Box	LinQ Cargo Rack 715003702	Adventure Roof Rack 715004095	LinQ Pivoting Rack 715010787	All-Terrain Trunk Cover 715003701	Passenger Seat Base
<b>LinQ ACCESSORIES WITH 16" BASE</b>		LinQ anchors mounted 16 inches apart, center-to-center. Lower loading capacity than the LinQ with 36" base accessories. Can be used on Can-Am ATV and SxS vehicles, Can-Am Spyder and Ryker vehicles, Sea-Doo watercraft and Ski-Doo snowmobiles.				
<b>NEW LinQ Rigid Cooler 4.7 US Gal (18 L)</b> 715010491	LinQ Base Installation Kit 715008125	LinQ Base Installation Kit 715008125	LinQ Base Installation Kit 715008125			
<b>NEW LinQ Cooler 5.3 US Gal (20 L)</b> 295101257 • Gray				No compatibility	No compatibility	No compatibility
<b>LinQ LinQ 11.4 US Gal (43 L) Cooler</b> 715007825 • Black 715009276 • Gray	Need to remove unused toe-in of the cooler to fit properly (Refer to instruction sheet)	No compatibility	No compatibility			
<b>LinQ 4.2 Gal Cooler</b> 295100698 • White 219400964 • Black	LinQ Base Installation Kit 715008125		LinQ Base Installation Kit 715008125	LinQ Anchor Adapter Kit 715004960	LinQ Base Installation Kit 715008125	Passenger Seat LinQ Anchor Kit 715003951
<b>LinQ Tool Kit</b> 715006829	No further requirements					
<b>LinQ Tool Box</b> 715008111	LinQ Base Installation Kit 715008125	No compatibility	LinQ Base Installation Kit 715008125	LinQ Anchor Adapter Kit 715004960	LinQ Base Installation Kit 715008125	Passenger Seat LinQ Anchor Kit 715003951
<b>LinQ SR 5.5 Gal (21 L) Bag</b> 860202449						
<b>LinQ 4.5 Gal (17 L) Sport Bag</b> 860202447						
<b>LinQ Modular Box</b> 715005494 • (10 L) 715007112 • (20 L) 715006830 • (30 L)	No further requirements					
<b>LinQ Roll-Top Bag</b> 715008110	LinQ Base Installation Kit 715008125	No compatibility	LinQ Base Installation Kit 715008125	LinQ Anchor Adapter Kit 715004960	LinQ Base Installation Kit 715008125	Passenger Seat LinQ Anchor Kit 715003951
<b>LinQ 26 US Gal (100 L) Explorer Bag</b> 295101016				No compatibility		
<b>LinQ 5.3 US Gal (20 L) Semi-Rigid Cooler</b> 295101252						
<b>LinQ ACCESSORIES WITH 36" BASE</b>		Mount on LinQ racks often used by Can-Am ORV vehicles. Higher loading capacity than the LinQ with 16" base accessories. Usage is limited to Can-Am ORV vehicles.				
<b>LinQ 12 Gal (45 L) Cargo Box</b> 715003879	No compatibility	No further requirements	No compatibility	No further requirements	No compatibility	No compatibility
<b>LinQ 23 Gal (86 L) Trunk Box</b> 715004923		No compatibility				
<b>LinQ 32 Gal (121 L) Trunk Box</b> 715001747		No further requirements				
<b>LinQ Audio Box</b> 715003018		No compatibility				
<b>LinQ Cooler</b> 715004778 • Black		No further requirements				
<b>LinQ OGIO Bag</b> 715002923 • Black		No further requirements				
<b>LinQ Heavy Duty Basket</b> 715001215		No further requirements				
<b>LinQ Low Profile Basket</b> 715004282		No further requirements				
<b>LinQ HOLDERS</b>						
<b>LinQ Gear Grips</b> 715005340	No further requirements (when installed on side walls)	No compatibility	Side wall installation LinQ Adapters 715003058	No further requirements	LinQ Base Installation Kit 715008125	No further requirements
<b>LinQ Tool Holder</b> 715007358						

The LinQ system is BRP's game-changing, tool-free cargo solution. Snap gear on or off in seconds. No fuss, no rattle, just rock-solid mounting on any terrain.

# LINQ SYSTEM ADVANTAGE

## ORIGINAL LinQ SYSTEM

Handles medium- to large-sized gear with two anchor setups: the 16" base for standard accessories and the 36" base for racks and serious payloads.

## LinQ LITE

Made for smaller items, lightweight gear you can hang from rails or vertical mounts.



### LinQ ACCESSORIES WITH 16" BASE

<b>NEW LinQ 5 US Gal (20 L) Fuel Caddy</b>	Commander, Commander MAX	<b>715007822</b>	<b>\$212.99</b>
--	--------------------------	------------------	-----------------



- Quick, easy and secure LinQ system installation.
- Spill-free spout for easy use.
- 5 US gal (20 L) capacity.
- Meets new Flame Mitigation Device (FMD) standard.
- Dimensions: 12" L x 19" W x 12" H.

<b>NEW LinQ Rigid Cooler 4.7 US Gal (18 L)</b>	Commander, Commander MAX, Maverick Trail, Maverick Sport, Maverick Sport MAX	<b>715010491</b>	<b>\$394.04</b>
--	--	------------------	-----------------



- Versatile LinQ 16" configuration fits many vehicles.
- Durable rotomolded rigid construction.
- Molded-in handles for quick installation and removal.
- High quality insulation for optimal ice retention.
- Sealed lid for airtight, weather-tight closure.
- Ergonomic and secure latch system offers excellent sealing.
- 4.7 US gal (18 L) capacity.

<b>NEW LinQ Cooler 5.3 US Gal (20 L)</b>	Commander, Commander MAX, Maverick Trail, Maverick Sport, Maverick Sport MAX	<b>295101257</b>	<b>\$409.99</b>
--	--	------------------	-----------------



- LinQ-mounted for fast, easy and secure storage.
- Locks in place with just a quarter turn.
- High-quality insulation for optimal ice retention.
- Keeps ice cold for 5 days.
- Rotomolded construction for exceptional rigidity and durability.
- Sealed lid for airtight, weather-tight closure.
- Rigid handles make transportation easy.
- Horizontal locking handles allow for installation of LinQ Lite accessories.
- Marinized hardware suited for saltwater applications.
- Holds thirty-four 355 ml cans.
- 5.3 US gal (20 L) capacity.
- Exterior dimensions: 21" L x 15" W x 14" H (52 cm L x 38 cm W x 35 cm H)
- Interior dimensions: 15" L x 10" W x 9" H (39 cm L x 26 cm W x 23 cm H)
- See table for installation location and requirements.

*Note: Cannot be mounted on the LinQ Stackable Fuel Caddy.*

<b>LinQ 11.4 US Gal (43 L) Cooler</b>	Commander, Commander MAX, Maverick Trail, Maverick Sport, Maverick Sport MAX	<ul style="list-style-type: none"> <li>■ <b>715007825</b> - Black</li> <li>■ <b>715009276</b> - Gray</li> </ul>	<b>\$638.99</b>
---------------------------------------	--	---	-----------------



- Versatile LinQ 16" configuration fits many vehicles.
- High quality injection-molded impact resistant polypropylene outer shell for exceptional durability.
- High quality insulation for optimal ice retention.
- Thicker insulation on bottom to isolate vehicle heat.
- 11.4 US gal (43 L) capacity.
- LinQ-mounted for fast, easy, secure storage.
- Locks in place with only a quarter turn.
- Rigid handles make transportation easy.
- Horizontal locking handles allow installation of LinQ Lite accessories.
- Dry-basket included to protect items.
- Drain plug at the bottom to evacuate water.
- New ergonomic and secure latch system offers excellent sealing.
- Possibility to lock the cooler with a padlock.
- LinQ Cargo Base Kit (715008125) required for installation.
- See table for installation location and requirements.

<b>LinQ Modular Box</b>	Commander, Commander MAX, Maverick Trail, Maverick Sport, Maverick Sport MAX	<b>715005494</b> - (10 L)	<b>\$148.99</b>
		<b>715007112</b> - (20 L)	<b>\$170.49</b>
		<b>715006830</b> - (30 L)	<b>\$191.49</b>



- Allows stacking of other modular boxes to always have the right gear accessible.
- Always have the right box size to fit everything.
- Can be installed on any LinQ base with a 16" width.
- See table for installation location and requirements.

<b>Thermal Insert for LinQ Modular Box (10 L)</b>	Commander, Commander MAX, Maverick Trail, Maverick Sport, Maverick Sport MAX	<b>219401110</b>	<b>\$63.99</b>
---	--	------------------	----------------



- Insulated liner.
- Fits very well in the LinQ Modular Box (10 L).
- Can contain seven 355 ml cans.
- Keeps ice cold for one day.
- Interior dimensions: 9" L x 17" W x 2½" H.

<b>LinQ Tool Box</b>	Commander, Commander MAX, Maverick Trail, Maverick Sport, Maverick Sport MAX	<b>715008111</b>	<b>\$191.49</b>
----------------------	--	------------------	-----------------



- High precision injected HDPE construction provides rigidity and durability.
- 5 gal (19 L) maximum capacity.
- Weather-resistant, sealed and lockable cover.
- Easy one-second on/off tool-less system.
- All the benefits of LinQ—simple, fast and secure.
- See table for installation location and requirements.

<b>LinQ Tool Kit</b>	Commander, Commander MAX, Maverick Trail, Maverick Sport, Maverick Sport MAX	<b>715006829</b>	<b>\$352.99</b>
----------------------	--	------------------	-----------------



- Includes:
- Cutter pliers
  - Long-nose pliers
  - Locking pliers
  - Ratchet wrench ¾" drive
  - 6" ratchet extension
  - Integrated CVT belt storage location (belt not included)
  - Long-socket 19 mm ¾" drive - 6 pts
  - Socket 18 mm ¾" drive
  - Long-socket 17 mm ¾" drive - 6 pts
  - Socket 15 mm ¾" drive
  - Socket 13 mm ¾" drive
  - Socket 10 mm ¾" drive
  - Socket 8 mm ¾" drive
  - Socket Torx T40 ¾" drive
  - Socket Torx T30 ¾" drive
  - Socket Torx T20 ¾" drive
  - Breaker bar ¾" drive
  - Combination Wrench set:
    - Wrench 19 mm
    - Wrench 18 mm
    - Wrench 15 mm
  - Wrench 13 mm
  - Wrench 10 mm
  - Wrench 8 mm
  - See table for installation location and requirements.

<b>LinQ 4.2 Gal (16 L) Cooler</b>	Commander, Commander MAX, Maverick Trail, Maverick Sport, Maverick Sport MAX	■ <b>219400964</b> - Black	<b>\$379.99</b>
		■ <b>295100698</b> - White	<b>\$379.99</b>



- All the benefits of LinQ—simple, fast and secure.
- Rotomolded construction for exceptional rigidity and durability.
- Premium-quality foam insulation for optimal ice retention.
- Uses LinQ mounting system (Patent US 8777531 and US 8875830).
- Easy one-second on/off tool-less system.
- Can contain twenty 355 ml cans.
- Keeps ice cold for three days.
- Exterior dimensions: 13" L x 20" W x 10" H.
- Interior dimensions: 9" L x 17" W x 7" H.
- See table for installation location and requirements.

<b>NEW LinQ 5.3 US Gal (20 L) Semi-Rigid Cooler</b>	Commander, Commander MAX, Maverick Trail, Maverick Sport, Maverick Sport MAX	<b>295101252</b>	<b>\$265.99</b>
---	--	------------------	-----------------



- 5.3 US gal (20 L) of insulated, water-resistant capacity.
- Quick, easy and secure LinQ system installation.
- Attaches with one set of LinQ fasteners.
- Single-day-use soft cooler.
- Mesh pocket on top of the lid.
- Zippered pocket under the lid for quick and easy access.
- Removable interior for easy cleaning.
- Carry handles for easy transport.
- Can contain twelve 355 ml cans.
- Dimensions: 19" L x 13" W x 10" H.

<b>LinQ 4.5 Gal (17 L) Sport Bag</b>	Commander, Commander MAX, Maverick Trail, Maverick Sport, Maverick Sport MAX	<b>860202447</b>	<b>\$223.49</b>
--------------------------------------	--	------------------	-----------------



- All the benefits of LinQ—simple, fast and secure.
- 17 liter (4.5 US gallon) capacity.
- Thermoformed bag base in HDPE (High Density Polyethylene) providing rigidity and durability.
- Rigid bottom, semi-rigid top.
- Easy one-second on/off tool-less system.
- See table for installation location and requirements.

<b>SR 5.5 Gal (21 L) LinQ Bag</b>	Commander, Commander MAX, Maverick Trail, Maverick Sport, Maverick Sport MAX	<b>860202449</b>	<b>\$244.99</b>
-----------------------------------	--	------------------	-----------------



- All the benefits of LinQ—simple, fast and secure.
- Semi-rigid expandable bag.
- 5.5 gal (21 L) capacity.
- Utilizes LinQ mounting system (Patent US 8777531 and US 8875830).
- Easy one-second on/off tool-less system.
- See table for installation location and requirements.

<b>LinQ Roll-Top Bag</b>	Commander, Commander MAX, Maverick Trail, Maverick Sport, Maverick Sport MAX	<b>715008110</b>	<b>\$244.99</b>
--------------------------	--	------------------	-----------------



- Fully waterproof roll-top dry bag will securely store and confine your equipment.
- LinQ mounted using heavy-duty rigid plastic base.
- High capacity storage solution (40 L).
- Bottom foam liner for additional equipment protection.
- Integrated handle for easy transportation on/off the vehicle.
- Dimensions: 14" L x 19" W x adjustable H.
- See table for installation location and requirements.

<b>LinQ Explorer Bag</b>	Commander, Commander MAX, Maverick Trail, Maverick Sport, Maverick Sport MAX	<b>295101016</b>	<b>\$478.99</b>
--------------------------	--	------------------	-----------------



- 26 gal (100 L) of watertight storage.
- Installs in seconds with tool-less LinQ accessory system.
- Dedicated essentials compartment for registration, license, insurance and more.
- Exclusive D.E.S.S. key storage.
- External quick-access pocket for small items like keys and wallets.
- Turns into a backpack when you get off your machine.
- Collapsible if not fully packed with straps on both sides.
- Dimensions: 26" L x 18" W x 14" H.
- Not compatible with LinQ Pivoting Rack (715010787).

## LinQ ACCESSORIES WITH 36" BASE

<b>LinQ Premium Storage Bag by OGIO</b>	Commander, Commander MAX, Maverick Trail, Maverick Sport, Maverick Sport MAX	<b>715002923</b> • Black	<b>\$532.49</b>
---	--	--------------------------	-----------------



- Tool-less installation and removal thanks to the LinQ system.
- 17.2 gal (65 L) capacity semi-rigid cargo bag ideal for carrying anything you need on your vehicle.
- Buckle and elastic closure with a rubber seal that prevents dust from entering the bag.
- 3-section lid for partial or full access to your bag.
- Inside separators for optimal bag organization.
- See table for installation location and requirements.

<b>LinQ 12 Gal (45 L) Cargo Box</b>	Commander, Commander MAX, Maverick Trail, Maverick Sport, Maverick Sport MAX	<b>715003879</b>	<b>\$329.99</b>
-------------------------------------	--	------------------	-----------------



- LinQ mounted for easy-on, easy-off installation.
- Holds cargo safely and securely while riding.
- See table for installation location and requirements.

<p><b>LinQ 23 Gal (86 L) Trunk Box</b></p> 	<p>Commander, Commander MAX, Maverick Trail, Maverick Sport, Maverick Sport MAX</p>	<p><b>715004923</b></p>	<p><b>\$393.99</b></p>		
<ul style="list-style-type: none"> <li>• LinQ mounted for easy-on, easy-off installation.</li> <li>• Holds cargo safely and securely while riding.</li> <li>• See table for installation location and requirements.</li> </ul>					
<p><b>LinQ 11.5 Gal (43 L) Audio Cargo Box</b></p> 	<p>Maverick Trail, Maverick Sport, Maverick Sport MAX</p>	<p><b>715003018</b></p>	<p><b>\$829.99</b></p>		
<ul style="list-style-type: none"> <li>• An affordable and quick solution for adding music and storage to your next ride.</li> <li>• The rear installation does not use up any cab space and allows easy listening at an average speed.</li> <li>• Mounts on/off easily to hold/carry cargo safely and securely.</li> <li>• Backlit control panel perfect for night riding.</li> <li>• Water-resistant speakers.</li> <li>• The Bluetooth<sup>®</sup> enabled receiver and 6.5" (16.5 cm) speakers are smartly concealed and integrated in the cover.</li> <li>• Automatic shut-off function protects your battery by turning the system off after 10 minutes of inactivity.</li> <li>• See table for installation location and requirements.</li> </ul>					
<p><b>LinQ 8 Gal (30 L) Cooler Box</b></p> 	<p>Commander, Commander MAX, Maverick Trail, Maverick Sport, Maverick Sport MAX</p>	<p>■ <b>715004778</b> • Black</p>	<p><b>\$469.99</b></p>		
<ul style="list-style-type: none"> <li>• LinQ mounted for easy-on, easy-off installation.</li> <li>• Rotomolded construction provides exceptional rigidity and durability.</li> <li>• Premium-quality foam insulation for optimal ice retention.</li> <li>• Integrated, fully removable compartment protects food.</li> <li>• Robust rubber latches keep the cover tightly closed.</li> <li>• Weather-resistant.</li> <li>• Convenient drain plug.</li> <li>• See table for installation location and requirements.</li> </ul>					
<p><b>LinQ 32 Gal (121 L) Trunk Box</b></p> 	<p>Maverick Trail, Maverick Sport, Maverick Sport MAX</p> <p>European Version (EC compliant)</p>	<p><b>715001747</b> • Black (Rear tail light included)</p> <p><b>715001748</b> • (No rear tail light)</p>	<p><b>\$577.99</b></p> <p><b>\$524.49</b></p>		
<ul style="list-style-type: none"> <li>• Equipped with the LinQ system, the rear trunk box plugs in and out in seconds.</li> <li>• 32 gal (121 L) load capacity with unobstructed space to maximize storage room and access to the trunk's interior.</li> <li>• Made of injection-molded polyethylene, double walled in critical areas.</li> <li>• The fully sealed lid protects your belongings from dust, moisture and the elements.</li> <li>• Trunk Box Panels available in many colors to match your vehicle (sold separately).</li> <li>• See table for installation location and requirements.</li> </ul>					
<p><b>LinQ 32 Gal (121 L) Trunk Box Panels</b></p> 	<p>Maverick Trail, Maverick Sport, Maverick Sport MAX</p>	<p><b>715001747</b> • Black <b>715001748</b> • (No rear tail light)</p>	<p><b>\$63.99</b></p>		
<ul style="list-style-type: none"> <li>• Color panels to match the LinQ 32 gal (121 L) to your vehicle (715001747 / 715001748).</li> </ul> <table border="0"> <tr> <td> <ul style="list-style-type: none"> <li>■ <b>715001391</b> • Black</li> <li>■ <b>715001392</b> • Yellow</li> <li>■ <b>715001395</b> • Viper Red</li> <li>■ <b>715002481</b> • White</li> <li>■ <b>715002480</b> • Light Gray</li> <li>■ <b>715002984</b> • Octane Blue</li> <li>■ <b>715002985</b> • Manta Green</li> <li>■ <b>715002986</b> • Can-Am Red</li> <li>■ <b>715006119</b> • Orange Crush</li> <li>■ <b>715006120</b> • Squadron Green</li> <li>■ <b>715007074</b> • Tundra Green</li> </ul> </td> <td> <ul style="list-style-type: none"> <li>■ <b>715001397</b> • Black</li> <li>■ <b>715001398</b> • Yellow</li> <li>■ <b>715002483</b> • White</li> <li>■ <b>715006121</b> • Can-Am Red</li> <li>■ <b>715006123</b> • Orange Crush</li> <li>■ <b>715006124</b> • Viper Red</li> </ul> </td> </tr> </table> <p>European Version (EC compliant). No rear tail light.</p>				<ul style="list-style-type: none"> <li>■ <b>715001391</b> • Black</li> <li>■ <b>715001392</b> • Yellow</li> <li>■ <b>715001395</b> • Viper Red</li> <li>■ <b>715002481</b> • White</li> <li>■ <b>715002480</b> • Light Gray</li> <li>■ <b>715002984</b> • Octane Blue</li> <li>■ <b>715002985</b> • Manta Green</li> <li>■ <b>715002986</b> • Can-Am Red</li> <li>■ <b>715006119</b> • Orange Crush</li> <li>■ <b>715006120</b> • Squadron Green</li> <li>■ <b>715007074</b> • Tundra Green</li> </ul>	<ul style="list-style-type: none"> <li>■ <b>715001397</b> • Black</li> <li>■ <b>715001398</b> • Yellow</li> <li>■ <b>715002483</b> • White</li> <li>■ <b>715006121</b> • Can-Am Red</li> <li>■ <b>715006123</b> • Orange Crush</li> <li>■ <b>715006124</b> • Viper Red</li> </ul>
<ul style="list-style-type: none"> <li>■ <b>715001391</b> • Black</li> <li>■ <b>715001392</b> • Yellow</li> <li>■ <b>715001395</b> • Viper Red</li> <li>■ <b>715002481</b> • White</li> <li>■ <b>715002480</b> • Light Gray</li> <li>■ <b>715002984</b> • Octane Blue</li> <li>■ <b>715002985</b> • Manta Green</li> <li>■ <b>715002986</b> • Can-Am Red</li> <li>■ <b>715006119</b> • Orange Crush</li> <li>■ <b>715006120</b> • Squadron Green</li> <li>■ <b>715007074</b> • Tundra Green</li> </ul>	<ul style="list-style-type: none"> <li>■ <b>715001397</b> • Black</li> <li>■ <b>715001398</b> • Yellow</li> <li>■ <b>715002483</b> • White</li> <li>■ <b>715006121</b> • Can-Am Red</li> <li>■ <b>715006123</b> • Orange Crush</li> <li>■ <b>715006124</b> • Viper Red</li> </ul>				
<p><b>LinQ Heavy-Duty Basket</b></p> 	<p>Commander, Commander MAX, Maverick Trail, Maverick Sport, Maverick Sport MAX</p>	<p><b>715001215</b></p>	<p><b>\$297.99</b></p>		
<ul style="list-style-type: none"> <li>• Made of high-strength, low-alloy steel.</li> <li>• LinQ mount for easy-on, easy-off installation.</li> <li>• See table for installation location and requirements.</li> </ul>					
<p><b>LinQ Low Profile Basket</b></p> 	<p>Commander, Commander MAX, Maverick Trail, Maverick Sport, Maverick Sport MAX</p>	<p><b>715004282</b></p>	<p><b>\$223.49</b></p>		
<ul style="list-style-type: none"> <li>• Low profile, open basket increases cargo space.</li> <li>• Perfect for easy access to tools, rope, winch and plow accessories.</li> <li>• Multiple bungee cord and tie-down anchor points.</li> <li>• Made of impact-resistant injected polypropylene.</li> <li>• See table for installation location and requirements.</li> </ul>					

## LinQ HOLDERS

<b>LinQ Tool Holder</b>	Commander, Commander MAX, Maverick Trail, Maverick Sport, Maverick Sport MAX	<b>715007358</b>	<b>\$63.99</b>
-------------------------	--	------------------	----------------



- Ultra-versatile tool holder.
- Convenient swivel-latch allows tools to be stored in any orientation.
- Sold in pairs.

<b>LinQ Gear Grips</b>	Commander, Commander MAX, Maverick Trail, Maverick Sport, Maverick Sport MAX	<b>715005340</b>	<b>\$160.49</b>
------------------------	--	------------------	-----------------



- Durable and flexible grips provide a custom fit for a variety of items from 1" to 4" (2.5 cm to 10 cm) in diameter.
- Heavy-duty design for carrying bows, fishing poles, rakes, farm tools and more.
- Quick-release button opens grip quickly for easy access to gear.
- Heavy-duty base system built for the toughest adventures.
- Make transporting your tools a snap by combining the Gear Grips with the LinQ system.
- 360° orientation.
- Sold in pairs.

## LinQ ACCESSORIES

<b>LinQ Adapter</b>	Commander, Commander MAX, Maverick Trail, Maverick Sport, Maverick Sport MAX	<b>715003058</b>	<b>\$36.99</b>
---------------------	--	------------------	----------------



- Sold in pack of 4.

<b>LinQ Base Installation Kit</b>	Commander, Commander MAX, Maverick Trail, Maverick Sport, Maverick Sport MAX	<b>715008125</b>	<b>\$31.99</b>
-----------------------------------	--	------------------	----------------



- Unique mounting fastener usable on any LinQ system accessory.
- Included: 2 cargo LinQ bases and hardware.

<b>LinQ Lock</b>	Commander, Commander MAX, Maverick Trail, Maverick Sport, Maverick Sport MAX	<b>860201968</b>	<b>\$66.99</b>
------------------	--	------------------	----------------



- Simple way to securely lock most LinQ accessories.
- Lock cover protects lock from the elements.
- Corrosion resistant.
- Pack of 1, includes 2 keys.
- Not compatible with LinQ 4.2 US Gal (16 L) Cooler, LinQ Tool Box, LinQ Tool Holder and LinQ Gear Grips.

<b>LinQ Replacement Part</b>	Maverick Trail, Maverick Sport, Maverick Sport MAX	<b>715010798</b>	<b>\$42.49</b>
------------------------------	--	------------------	----------------



- Unique mounting fastener usable on any LinQ system accessory.
- Tool-less installation and removal.
- Sold in pairs.

<b>LinQ Anchor Adapter kit</b>	Maverick Trail, Maverick Sport, Maverick Sport MAX	<b>715004960</b>	<b>\$84.99</b>
--------------------------------	--	------------------	----------------



- Allows the installation of LinQ accessories with 16" base on LinQ racks.
- Tool-less installation and removal.
- LinQ pivoting rack is required for installation.

# CARGO & STORAGE

## CARGO

<b>LinQ Cargo Rack</b>	Commander, Commander MAX	<b>715006815</b>	<b>\$489.99</b>
------------------------	--------------------------	------------------	-----------------

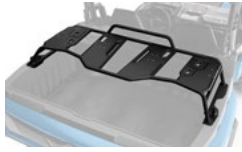

- Strong, durable steel rack 7/8".
- Easy and tool-less installation with LinQ system.
- Allows the installation of LinQ accessories.
- Allows multi-level storage on cargo bed.
- Helps keep cargo securely in place.
- Multiple bungee cord and tie-down points.
- Kit includes LinQ Base 36".
- 15" clearance under the rack for other cargo.
- Not compatible with Tonneau Cover (715006816).
- Not compatible with the LinQ Gun Case (715009240).

<b>Integrated Tailgate Extension</b>	Commander, Commander MAX	<b>715006810</b>	<b>\$350.99</b>
--------------------------------------	--------------------------	------------------	-----------------



- Integrated design that lets the extension fold away inside the tailgate when not needed.
- Steel construction for rugged durability.
- Not EC compliant.

<b>Tonneau Cover</b>	Commander, Commander MAX	<b>715006816</b>	<b>\$308.49</b>
----------------------	--------------------------	------------------	-----------------



- Fitted to cover all of the items in your cargo box.
- Prevents splash from entering the cargo box.
- Rolls up to the front.
- Easily removable for quick access.
- Not compatible with accessories that exceed the bed height.

<b>All-Terrain Trunk Cover</b>	Maverick Trail, Maverick Sport (except X mr), Maverick Sport MAX	<b>715003701</b>	<b>\$619.99</b>
--------------------------------	---	------------------	-----------------



- Transforms your rear cargo area into a fully enclosed and weather-resistant car-like trunk box.
- Gas spring assisted opening.
- Integrated mounting location inside the trunk cover for Dome Light (715009228) (sold separately).
- Rotomolded construction provides exceptional rigidity.
- LinQ accessories can be installed on or inside the trunk cover.
- LinQ Base Installation Kit required for installation on the trunk cover.

<b>Fixed Tailgate</b>	Maverick Trail, Maverick Sport, Maverick Sport MAX	<b>715004357</b>	<b>\$223.49</b>
-----------------------	---	------------------	-----------------



- Rigid rotomolded construction.
- Encloses the rear cargo opening perfectly and helps keep cargo securely in place.
- Matches the vehicle's styling.

## STORAGE

<b>Soft Storage Bag</b>	Commander, Commander MAX, Maverick Trail, Maverick Sport, Maverick Sport MAX	<b>715003759</b>	<b>\$191.49</b>
-------------------------	--	------------------	-----------------



- 11.8 gal (45 L) capacity soft cargo bag designed with vehicle's rear in mind to maximize potential storage.
- 3-section bag.
- Transport gear in a weatherproof bag.

<b>Storage 2.6 Gal (10 L) Bag</b>	Commander, Commander MAX, Maverick Trail, Maverick Sport, Maverick Sport MAX	<b>269502121</b>	<b>\$40.49</b>
-----------------------------------	--	------------------	----------------



- Roll-top dry bag for fully protecting your cargo from the elements.

<b>Overhead Storage Bags</b>	Commander, Commander MAX, Maverick Trail, Maverick Sport, Maverick Sport MAX	<b>715005018</b>	<b>\$164.99</b>
------------------------------	--	------------------	-----------------



- Weather-resistant bags, hold your gear safely and securely while riding.
- Include 2 overhead soft bags mounted on a tubular frame that sits between cage and roof.
- 2.4 gal (9 L) total capacity.
- Bimini Roof with Sun Visor or Sport Roof needed for installation.
- Not compatible with the Complete Wet Sounds Audio System.

<b>Shoulder Storage Bag</b>	Commander, Commander MAX, Maverick Trail, Maverick Sport, Maverick Sport MAX	<b>715005019</b>	<b>\$127.49</b>
-----------------------------	--	------------------	-----------------



- Weather-resistant semi-rigid bag holds your gear safely and securely while riding.
- Bag attaches in unused space between the seats to increase your vehicle's cargo capacity.
- 2.8 gal (10.5 L) capacity.

<b>Removable Central Storage Bag</b>	Commander MAX, Maverick Sport MAX	<b>715004794</b>	<b>\$159.49</b>
--------------------------------------	-----------------------------------	------------------	-----------------



- Weather-resistant bag holds your gear safely and securely while riding.
- Both front and rear passengers can access the bag's contents.
- Designed as a 1.3 gal (5.2 L) capacity pocket, also equipped with inner netting compartments and side pockets.
- Can be removed in seconds and includes shoulder strap for transportation.
- Perfect to bring your gear on and off your vehicle.

<b>Passenger Storage Seat Bag</b>	Commander, Commander MAX, Maverick Trail, Maverick Sport, Maverick Sport MAX	<b>715008080</b>	<b>\$265.99</b>
-----------------------------------	---	------------------	-----------------



- This weather-resistant bag holds your gear safely and securely while you ride.
- Bag settling on the passenger's seat to increase the vehicle's cargo capacity.
- This bag features a 14.5 gal (55 L) storage capacity and is divided into two compartments.
- The top compartment is insulated to keep your beverages cold and includes two cup holders.
- Additional pocket inside for additional storage, such as a cell phone.
- The bottom compartment is accessible from both sides and serves as a large pocket for storing various items.
- The detachable pocket at the front of the bag can be used as a garbage bag.

<b>Soft Cooler</b>	Commander, Commander MAX, Maverick Trail, Maverick Sport, Maverick Sport MAX	<b>715003728</b>	<b>\$42.49</b>
--------------------	--	------------------	----------------







- Soft cooler made of durable canvas.
- Removable shoulder strap and carry handles.
- Foam insulation and water-resistant interior liner.
- 2.2 gal (4.5 L) capacity.

# RACKS & HOLDERS

<b>Adventure Roof Rack</b>	Commander, Commander MAX, Maverick Sport MAX	<b>715004095</b>	<b>\$830.49</b>
	<ul style="list-style-type: none"> <li>• Ideal cargo solution for packing everything you need to live your off-road experience fully and completely.</li> <li>• Built with heavy-duty 1.5" (3.8 cm) and 1.25" (3.2 cm) diameter steel tubing.</li> <li>• Loads of up to 75 lb (34 kg).</li> <li>• LinQ support plates allow for installation of accessories with 16" base.</li> <li>• Integrated mounting points for the installation of the 39" (99 cm) Double Stacked LED Bar (front).</li> <li>• Features anchor points for spare tire attachment.</li> <li>• Spare Tire Tie-Downs sold separately.</li> <li>• Add the Cargo Box Net to secure and confine your cargo in the rack.</li> <li>• Can be installed without a roof or with Sport Roof only.</li> <li>• Commander: Compatible with Rear Adventure Rack (715006809).</li> </ul>		
<b>Rear Adventure Rack</b>	Commander, Commander MAX	<b>715006809</b>	<b>\$1,016.49</b>
	<ul style="list-style-type: none"> <li>• Made of heavy-duty steel.</li> <li>• Increases the cargo versatility of the vehicle.</li> <li>• Allows a Commander 2-up to fit a MAX Sport Roof or Bimini Roof on top to protect the cargo area.</li> <li>• Allows a Commander 2-up to fit MAX Adventure Roof Rack to increase cargo capacity.</li> <li>• Not compatible with other bed installed accessories.</li> </ul>		
<b>Adventure Rack Enclosure</b>	Commander Commander MAX	<b>715006818</b> <b>715008246</b>	<b>\$959.99</b>
	<ul style="list-style-type: none"> <li>• Works with Rear Adventure Rack.</li> <li>• Rear-panel zip-type windows with roll-down feature.</li> <li>• Covers all accessories mounted inside of the Rear Adventure Rack.</li> <li>• Compatible only with Sport Roof.</li> <li>• Compatible with Track Kit and Pre-filter only in Pickup configuration.</li> <li>• Track Kit and Pre-filter are not compatible with the SUV configuration.</li> <li>• Not compatible with snorkel kits or X mr models.</li> </ul>		
<b>Cargo Bed Rails</b>	Commander, Commander MAX	<b>715006824</b>	<b>\$223.49</b>
	<ul style="list-style-type: none"> <li>• Add an integrated tie-down area to your cargo box.</li> <li>• Added cargo box protection.</li> <li>• Inside and outside anti-corrosion coating with durable powder-coat finish.</li> <li>• Heavy-duty 1" (2.5 cm) diameter steel tube construction.</li> <li>• Adds height to the bed side wall and serves as a tie-down point.</li> <li>• Sold in pairs.</li> </ul>		
<b>Deluxe Headache Rack</b>	Commander, Commander MAX (except X mr models)	<b>715006823</b>	<b>\$436.49</b>
	<ul style="list-style-type: none"> <li>• Protects cab from cargo load.</li> <li>• Compatible with cargo bed rails.</li> <li>• Not compatible with Snorkel Kit (715003705).</li> </ul>		
<b>LinQ Pivoting Rack</b>	Maverick Trail, Maverick Sport, Maverick Sport MAX	<b>715010787</b>	<b>\$599.19</b>
	<ul style="list-style-type: none"> <li>• LinQ latched rack allows for extra LinQ mounted accessories or the addition of ATV LinQ rack extensions.</li> <li>• Includes custom tie-down strap for fast spare tire installation or removal (tire not included).</li> <li>• Gas-cylinder pivot action, locks in the raised position.</li> <li>• Not compatible with Gear Rail (715003703), Lonestar Racing and DragonFire tire carrier, Lonestar Racing Number Plate, Rear Intrusion Bars and LinQ Cargo Rack.</li> <li>• Compatible with the All-Terrain Trunk Cover.</li> </ul>		
<b>LinQ Rack Extension</b>	Maverick Trail, Maverick Sport, Maverick Sport MAX	<b>715003771</b>	<b>\$271.49</b>
	<ul style="list-style-type: none"> <li>• Made of strong and durable die-cast-aluminum.</li> <li>• Helps to keep cargo securely in place.</li> <li>• Easy and tool-less installation thanks to the LinQ system.</li> </ul>		

<b>LinQ Cargo Rack</b>	Maverick Trail, Maverick Sport, Maverick Sport MAX	<b>715003702</b>	<b>\$457.99</b>
	<ul style="list-style-type: none"> <li>• Made of durable die-cast aluminum and strong aluminum tubing frame.</li> <li>• Allows the installation of LinQ Trunk Boxes on top and the addition of more LinQ accessories in cargo box.</li> <li>• Easy and tool-less installation thanks to the LinQ system.</li> </ul>		
<b>Spare Tire Carrier</b>	Maverick Trail, Maverick Sport, Maverick Sport MAX	<b>715004471</b>	<b>\$255.49</b>
	<ul style="list-style-type: none"> <li>• Holds spare tire in place.</li> <li>• Designed for fast tire removal.</li> <li>• Can hold tires up to 30" in diameter (tire is not included).</li> <li>• Rear bumper mounted, does not encumber the cargo area.</li> <li>• Made of heavy-duty 1.5" (3.8 cm) diameter steel tubing.</li> <li>• Inside and outside anti-corrosion coating with durable powder coat finish.</li> <li>• Requires Rear Trail Bumper (715007109) or Rear Rancher Bumper (715004304).</li> </ul>		
<b>Cargo Box Net</b>	Commander, Commander MAX, Maverick Sport MAX	<b>715001371</b>	<b>\$76.49</b>
	<ul style="list-style-type: none"> <li>• Solid net designed to secure and ensure the compact confinement of your Adventure Roof Rack.</li> </ul>		
<b>LinQ Tool and Gun Holder</b>	Commander, Commander MAX	<b>715005466</b>	<b>\$566.99</b>
	<ul style="list-style-type: none"> <li>• 2-in-1 holding rack can be used both on the job or on the hunt.</li> <li>• Includes 5 locations to securely hold tools and guns using rubber grips and retention straps at the top and a rubber mat with gunstock shaped molding at the bottom.</li> <li>• Easy to remove, install or reposition using our simple and secure LinQ system.</li> <li>• Can be attached at multiple positions along the cargo bed walls, facing inside or outside the bed.</li> <li>• Can be attached on the inside of the cargo, behind the cab.</li> <li>• Not compatible with Headache Rack.</li> </ul>		
<b>LinQ Gun Case</b>	Commander, Commander MAX, Maverick Trail, Maverick Sport, Maverick Sport MAX	<b>715009240</b>	<b>\$277.99</b>
	<ul style="list-style-type: none"> <li>• Practical design allows you to store shotguns and rifles up to 52" (132 cm) even with optics.</li> <li>• Adapt to different weapon shapes and features with foam cushions that can be repositioned.</li> <li>• LinQ-mounted for efficient and secure storage, locked in place with only a quarter turn.</li> <li>• No mount required on Commander and Commander MAX.</li> <li>• Mount kit required for Maverick Trail, Maverick Sport and Maverick Sport MAX.</li> <li>• Commander &amp; Commander MAX: Not compatible with LinQ Cargo Rack (715006815).</li> </ul>		
<b>LinQ Gun Case Mounting Kit</b>	Maverick Sport, Maverick Sport MAX, Maverick Trail	<b>715006444</b>	<b>\$74.99</b>
	<ul style="list-style-type: none"> <li>• Required to install the Can-Am Gun Case on a Maverick Sport, Maverick Sport MAX and Maverick Trail.</li> <li>• Allows you to install up to two LinQ gun cases.</li> </ul>		
<b>Gear Rail</b>	Maverick Trail, Maverick Sport, Maverick Sport MAX	<b>715003703</b>	<b>\$319.49</b>
	<ul style="list-style-type: none"> <li>• Sturdy gear rail design with C-clamps attached on the roll cage.</li> <li>• Offers mounting points for the Stronghold Auto-Latch Mount or for the Universal Saw Press by Kolpin.</li> <li>• Can hold up to two gun boots.</li> <li>• Not compatible with the Gun Boot 6.0 Impact by Kolpin (715001419).</li> </ul>		
<b>Universal Saw Press by Kolpin</b>	Maverick Trail, Maverick Sport, Maverick Sport MAX	<b>715001423</b>	<b>\$154.99</b>
	<ul style="list-style-type: none"> <li>• Specially crafted for transporting your chainsaw securely and safely aboard your side-by-side vehicle.</li> <li>• Heavy-duty, black powder-coated metal bracket designed to attach any chainsaw model with up to a 20" (51 cm) bar.</li> <li>• Rubber pads provide cushion and tight fit.</li> <li>• Hinged design for quick removal.</li> <li>• Holds saw in vertical position or 45° angle in either direction.</li> <li>• Requires Gear Rail (715003703).</li> <li>• Protective sheath included.</li> </ul>		

<b>Spare Tire Ratchet Tie-Downs</b>	Commander, Commander MAX, Maverick Trail, Maverick Sport, Maverick Sport MAX	<b>280000955</b>	<b>\$35.49</b>
	<ul style="list-style-type: none"> <li>• 3-way ratcheting tie-down strap with loop ends.</li> <li>• Designed to securely hold spare tires on accessories equipped with integrated spare tire attachment points.</li> <li>• Adjustable to accommodate most common UTV tire sizes.</li> </ul>	<ul style="list-style-type: none"> <li>• Ratchet and junction ring made of durable zinc-plated steel.</li> <li>• Required for spare tire attachment on Adventure Roof Rack and LinQ Pivoting Rack.</li> </ul>	
<b>Heavy-Duty Ratchet Tie-Down</b>	Commander, Commander MAX, Maverick Trail, Maverick Sport, Maverick Sport MAX	<b>715008308</b>	<b>\$47.99</b>
	<ul style="list-style-type: none"> <li>• 1,000 lb (454 kg) safe working load.</li> <li>• 1.5 in. x 6 in. (38 mm x 1.8 mm) strap with BRP brands.</li> <li>• Deluxe ratchet with rubber handle.</li> <li>• Black-coated clip hooks.</li> </ul>	<ul style="list-style-type: none"> <li>• 12" (300 mm) webbing included.</li> <li>• Pack of two.</li> </ul>	
<b>Bolt-On<sup>†</sup> Retractable Ratcheting Tie-Downs</b>	Commander, Commander MAX, Maverick Trail, Maverick Sport, Maverick Sport MAX	<b>295101072</b>	<b>\$38.49</b>
	<ul style="list-style-type: none"> <li>• Perfect for transporting your powersport vehicle or securing loads.</li> <li>• Mounts easily: Bolts on any flat surface (e.g., truck bed or frame).</li> <li>• 1" x 6' (2.5 cm x 1.8 m) tie-down strap with heavy-duty stitching that delivers a 500 lb (226 kg) working load strength and 1,500 lb (680 kg) break strength.</li> </ul>	<ul style="list-style-type: none"> <li>• Convenient retractable push button automatically slackens, spools and stores away strap, while the ratchet mechanism tightens the strap snugly to secure your vehicle or load into place.</li> <li>• Rubber ratcheting handle provides firm grip, and the hook is vinyl coated to protect whatever surface it hooks into.</li> <li>• Sold in pairs.</li> </ul>	
<b>Ratchet Tie-Downs</b>	Commander, Commander MAX, Maverick Trail, Maverick Sport, Maverick Sport MAX	<b>715008309</b> • Black/Gray	<b>\$31.99</b>
	<ul style="list-style-type: none"> <li>• 400 lb (181 kg) safe working load.</li> <li>• 1" x 10' (2.5 cm x 3 m) strap with Sea-Doo, Ski-Doo and Can-Am logos.</li> <li>• Deluxe ratchet with rubber handle.</li> </ul>	<ul style="list-style-type: none"> <li>• Coated S hooks.</li> <li>• Pack of 2.</li> </ul>	

# LIGHTS

## CAN-AM LIGHTS

1 CHOOSE YOUR MOUNT POINT	2 CHOOSE YOUR LIGHTS						
	10" Double Stacked LED Bar 715002933	15" Double Stacked LED Bar 715002934	39" Double Stacked LED Bar 715004007	4" Round LED Lights (sold in pairs) 715002935	3.5" Spot or Flood LED Lights (sold in pairs) 715009774 /715009775	SMART 40" (102 cm) LED Light Bar 715008747	SMART 10" (25 cm) LED Light Bar 715008745
<b>XT &amp; X mr Front Bumper</b> 715007631, 715007428 (Stock on XT, XT-P and X mr)	715003670 (Power Cable)	715003670 (Power Cable)	No compatibility	715003670 (Power Cable)	No compatibility	No compatibility	715009886 (Lights Wiring Harness)
<b>S3<sup>+</sup> Front Bumper</b> 715005121 & <b>Trail Bumper</b> 715003680, 715003681	No compatibility	No compatibility					
<b>Commander Front Bumper</b>	No compatibility	715003670 (Power Cable)					
<b>Sport Roof &amp; Bimini Roof</b>	715003670 (Power Cable) + 715003669 (Overhead Switch Panel)	715003669 (Overhead Switch Panel)	715005822 (Mounting Kit) *Optional Overhead Switch Panel 715003669	715003669 (Overhead Switch Panel)	715011297 (LED Light Bar Mounting Kit) + 715003669 (Overhead Switch Panel) + 715009930 (LED Light Bar Harness)	715011297 (LED Light Bar Mounting Kit) + 715003669 (Overhead Switch Panel) + 715009886 (Lights Wiring Harness)	
<b>Top Roll Cage</b>	No compatibility	No compatibility	715005822 (Mounting Kit)	No compatibility	No compatibility	No compatibility	No compatibility
<b>Sport Roof</b> Back Position			No compatibility	No compatibility	No compatibility	No compatibility	715004910 (Power Cable) + 715003669 (Overhead Switch Panel)

## BAJA DESIGNS<sup>+</sup> LIGHTS

1 CHOOSE YOUR MOUNT POINT	2 CHOOSE YOUR LIGHTS			
	10" (25 cm) LED Light Bar 715006819	XL Sport LED Lights (sold in pairs) 710006821	Squadron Sport LED Lights (sold in pairs) 710006820	XL80 LED Lights (sold in pairs) 710005041
<b>XT &amp; X mr Front Bumper</b> 715007631, 715007428 (Stock on XT, XT-P and X mr)	710006819 (X mr Only) + 715007049 (Power Cable)	715008865 (Power Cable)	715008865 (Power Cable)	715007049 (Power Cable)
<b>S3<sup>+</sup> Front Bumper</b> 715005121 & <b>Trail Bumper</b> 715003680, 715003681	No compatibility			
<b>Commander Front Bumper</b>	715007049 (Power Cable)			
<b>Sport Roof &amp; Bimini Roof</b>	715007049 (Power Cable) *Optional Overhead Switch Panel 715003669	715008865 (Power Cable) *Optional Overhead Switch Panel 715003669	715008865 (Power Cable) *Optional Overhead Switch Panel 715003669	715007049 (Power Cable) *Optional Overhead Switch Panel 715003669
<b>Top Roll Cage</b>	No compatibility	No compatibility	No compatibility	No compatibility
<b>Sport Roof</b> Back Position				

### 3 ORDER

#### ORDER ALL PART NUMBERS IN INTERSECTING BOX

\*Note: When installing more than one light kit, additional light power cable or mounting kit is required.

\*All lights are intended for off-road use only.

**NEW SMART 10" (25 cm) LED Light Bar**

Commander, Commander MAX,  
Maverick Trail, Maverick Sport,  
Maverick Sport MAX

**715008745**

**\$374.49**



- The perfect combination of powerful white and selective yellow LEDs.
- The selective yellow LEDs are ideal for driving in low visibility conditions.
- The light is composed of 16 white LEDs and 8 yellow LEDs.
- Spot and Flood combo beam.
- The side lens design provides highly effective wide-angle illumination.
- The white LEDs produce 8,100 raw lumens and the selective yellow 2,640 raw lumens, delivering stunning lighting performance.
- The lens is made from hard-coated polycarbonate.
- IP67 and IP69k submersible and pressure washer safe.
- Switch options: Off, Low and High. Color change by flicking the switch quickly.
- Lights Wiring Harness (715009886) is required for installation. Sold separately.
- See table for installation location and requirements.

**NEW SMART 40" (102 cm) LED Light Bar**

Commander, Commander MAX,  
Maverick Trail, Maverick Sport,  
Maverick Sport MAX

**715008747**

**\$1,069.99**



- The perfect combination of powerful white or selective yellow LEDs.
- The selective yellow LEDs are ideal for driving in low visibility conditions.
- The light is composed of 64 white LEDs and 32 yellow LEDs.
- Spot and Flood combo beam.
- The side lens design provides highly effective wide-angle illumination.
- The white LEDs produce 32,000 raw lumens and the selective yellow 10,560 raw lumens, delivering stunning lighting performance.
- The lens is made from hard-coated polycarbonate.
- IP67 and IP69k submersible and pressure washer safe.
- Switch options: Off, Low and High. Color change by flicking the switch quickly.
- Wiring harness (715009930) is required for installation. Sold separately.
- See table for installation location and requirements.

**10" (25 cm) Double Stacked LED Light Bar (60 W)**

Commander, Commander MAX,  
Maverick Trail, Maverick Sport,  
Maverick Sport MAX

**715002933**

**\$395.49**



**5,400 lumens**

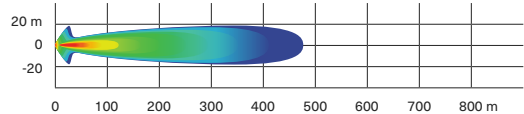

- Equipped with twelve 5 W Cree LEDs.
- 5,400 lumens.
- Packs a big punch for its size.
- Rugged and waterproof.
- Can be installed in stock XT and XT-P bumpers.
- Requires light power cable for installation.
- Lights up to more than 1,500 ft (460 m) in front of the vehicle and around 65 ft (20 m) wide on each side.
- EC compliant.
- See table for installation location and requirements.

**15" (38 cm) Double Stacked LED Light Bar (90 W)**

Commander, Commander MAX,  
Maverick Trail, Maverick Sport,  
Maverick Sport Max

**715002934**

**\$480.99**



**8,400 lumens**

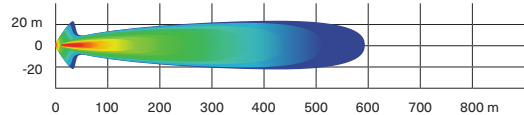

- Equipped with 18 5 W Cree LEDs.
- 8,400 lumens.
- Complements the Light Racks and most bumpers.
- Rugged and waterproof.
- Lights up to more than 1,900 ft (580 m) in front of the vehicle and around 65 ft (20 m) wide on each side.
- EC compliant.
- See table for installation location and requirements.

**39" (99 cm) Double Stacked LED Light Bar (270 W)**

Commander, Commander MAX,  
Maverick Trail, Maverick Sport,  
Maverick Sport Max

**715004007**

**\$940.99**



**24,300 lumens**

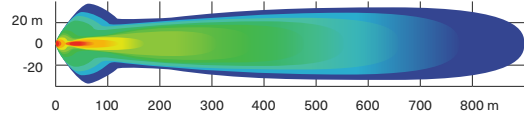

- Equipped with 54 5 W Cree LEDs.
- 24,300 lumens.
- Lights up to more than 2,900 ft. (900 m) in front of the vehicle and around 115 ft. (35 m) wide on each side.
- Compatible on the Adventure Roof Rack.
- See table for installation location and requirements.

### Baja Designs 10" (25 cm) OnX6 LED Light Bar

Commander, Commander MAX,  
Maverick Trail, Maverick Sport,  
Maverick Sport Max

710006819

\$591.49



12,460  
lumens

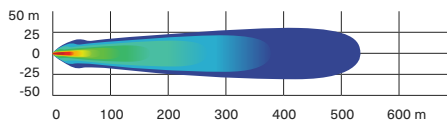

- 108 W light bar producing 12,460 lumens.
- Equipped with 6 Cree XM-L2 LEDs.
- Driving/combo light pattern for smooth blend of light for both near field applications and distance.

- Dual intensity (high/low) settings.
- Requires Baja Designs Light Power Cable.
- See table for installation location and requirements.

### Baja Designs XL80 LED Lights

Commander, Commander MAX,  
Maverick Trail, Maverick Sport,  
Maverick Sport Max

710005041

\$1,117.99



9,500  
lumens

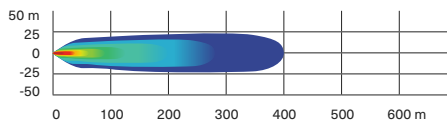

- 80 W per spot producing 9,500 lumens.
- Equipped with 4 Cree XHP50 LEDs per spot.
- Dual intensity (high/low) settings.
- Driving/combo light pattern for smooth blend of light for both near field applications and distance.

- Require Baja Designs Light Power Cable.
- Sold in pairs.
- Dimensions: 4.5" x 4.5" (11.4 cm x 11.4 cm).
- See table for installation location and requirements.

### Baja Designs Squadron Sport LED Lights

Commander, Commander MAX,  
Maverick Trail, Maverick Sport,  
Maverick Sport Max

710006820

\$309.99



3,150  
lumens

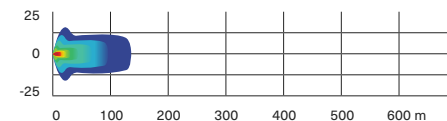

- 26 W per spot producing 3,150 lumens.
- Equipped with 4 Cree XP-G2 LEDs per spot.
- Wide cornering light pattern designed specifically for cornering, dust and/or fog conditions.

- Require Baja Designs Light Power Cable.
- Sold in pairs.
- Dimensions: 3" x 3" (7.6 cm x 7.6 cm).
- See table for installation location and requirements.

### Baja Designs XL Sport LED Lights

Commander, Commander MAX,  
Maverick Trail, Maverick Sport,  
Maverick Sport Max

710006821

\$529.99



3,150  
lumens

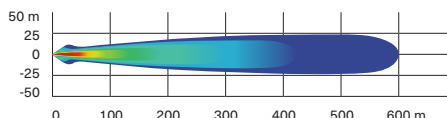

- 26 W per spot producing 3,150 lumens.
- Equipped with 4 Cree XP-G2 LEDs per spot.
- High Speed Spot features a longer and narrower beam focus for illumination farther down.

- Require Baja Designs Light Power Cable.
- Sold in pairs.
- Dimensions: 4.5" x 4.5" (11.4 cm x 11.4 cm).
- See table for installation location and requirements.

### 4" (10 cm) Round LED Lights (2 x 25 W)

Commander, Commander MAX,  
Maverick Trail, Maverick Sport,  
Maverick Sport Max

715002935

\$480.99



1,800  
lumens

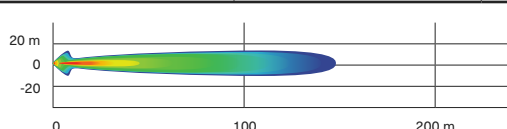

- 25 W LED spotlights.
- 1,800 lumens.
- Rugged and waterproof.
- Includes basic wiring and switch.
- Can-Am branded grill.

- Requires light power cable.
- Sold in pairs.
- Not EC compliant.
- See table for installation location and requirements.

### 3.5" (9 cm) LED Driving Lights (2 x 14 W)

Commander, Commander MAX,  
Maverick Trail, Maverick Sport,  
Maverick Sport Max

715009775

\$283.49

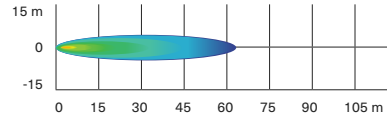

- 14 W LED lights producing 1,260 lumens each.
- Spot lens for a narrow and long light beam spread, ideal when driving at higher speeds.
- Equipped with six high-power LEDs in a heavy-duty die-cast aluminum housing.

- Features two attachment points. If one attachment point fails due to a collision, rotate to the next channel point and remount the light.
- Sold in pairs.
- EC compliant.
- See table for installation location and requirements.

### 3.5" (9 cm) LED Flood Lights (2 x 14 W)

Commander, Commander MAX,  
Maverick Trail, Maverick Sport,  
Maverick Sport Max

715009774

\$283.49

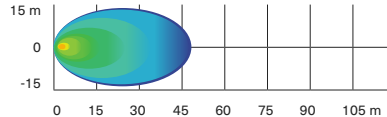

- 14 W LED lights producing 1,260 lumens each.
- Flood lens for a wide light beam spread, ideal for working applications like plowing or cornering. Suitable for dusty or foggy riding conditions.
- Equipped with six high-power LEDs in a heavy-duty die-cast aluminum housing.

- Features two attachment points. If one attachment point fails due to a collision, rotate to the next channel point and remount the light.
- Sold in pairs.
- EC compliant.
- See table for installation location and requirements.

### LED Headlights Assembly

Commander, Commander MAX,  
Maverick Trail, Maverick Sport,  
Maverick Sport MAX

715003667

\$879.99



- The headlights in this upgrade kit draw a maximum of 40 W (2 x 20 W) of power while providing brighter light output.
- Lower power consumption and longer lasting than standard halogen bulbs.

### LED Signature Lights

Commander, Commander MAX

715006896

\$271.49



- The stylish LED set adds a finishing touch, accentuating its aggressive stance.

### Can-Am LED Signature Lights

Maverick Trail, Maverick Sport,  
Maverick Sport MAX

715003673

\$259.99



- Add style with a more aggressive look.
- Use bright and energy efficient LEDs.
- Do not give additional lighting for driving.

### NEW Dome Light

Commander, Commander MAX,  
Maverick Trail, Maverick Sport,  
Maverick Sport MAX

715009228

\$96.49



- Offers an optimal visibility in the cab and integrates perfectly with the vehicle.
- 160 lumens of soft white light ensure clear visibility of the surroundings.
- Built in on/off button on the light.
- Wiring included.
- Can be installed on cage, Sport Roof or All-Terrain Trunk Cover.

<b>NEW SMART 40" (102 cm) LED Light Bar Harness</b> <i>(Not illustrated)</i>	Commander, Commander MAX, Maverick Trail, Maverick Sport, Maverick Sport MAX	<b>715011297</b>	<b>\$26.74</b>
---	--	------------------	----------------

- Required to install the SMART 40" (102 cm) LED Light Bar (715008747).

<b>Light Power Cable</b> <i>(Not illustrated)</i>	Commander, Commander MAX, Maverick Trail, Maverick Sport, Maverick Sport MAX	<b>715003670</b>	<b>\$63.99</b>
--	--	------------------	----------------

- Power cable for installation of compatible Can-Am light kits on front bumpers or roof.

<b>Mounting Kit for 39" (99 cm) LED Light Bar</b> <i>(Not illustrated)</i>	Commander, Commander MAX, Maverick Trail, Maverick Sport, Maverick Sport MAX	<b>715005822</b>	<b>\$170.99</b>
---	--	------------------	-----------------

- Required for installation of the 39" (99 cm) double stacked LED Light Bar.
- Includes wiring and support bracket.
- Light Support Bar required for installation.

<b>NEW Lights Wiring Harness</b>	Commander, Commander MAX, Maverick Trail, Maverick Sport, Maverick Sport MAX	<b>715009886</b>	<b>\$85.59</b>
----------------------------------	--	------------------	----------------



- Power cable for installation of the SMART 10" (25 cm) LED Light Bar (715008745).

<b>Roof Power Cable</b> <i>(Not illustrated)</i>	Commander, Commander MAX, Maverick Trail, Maverick Sport, Maverick Sport MAX	<b>715003094</b>	<b>\$63.99</b>
---	--	------------------	----------------

- Brings power from the battery.
- Required for installation of some electrical accessories.

<b>Rear Lights Power Cable</b> <i>(Not illustrated)</i>	Commander, Commander MAX, Maverick Trail, Maverick Sport, Maverick Sport MAX	<b>715004910</b>	<b>\$63.99</b>
--	--	------------------	----------------

- Power cable that allows you to install rear cargo lights on your vehicle.
- Use in conjunction with the 3.5" (9 cm) LED Flood Lights (2 x 14 W) (sold separately).
- This set-up will illuminate your rear cargo area and surroundings.
- Sport Roof and Overhead Switch Panel (715003669) required.

<b>Baja Designs Light Power Cable</b> <i>(Not illustrated)</i>	Commander, Commander MAX, Maverick Trail, Maverick Sport, Maverick Sport MAX	<b>715008865</b>	<b>\$160.99</b>
---	--	------------------	-----------------

- Required for installation of Baja Designs LED lights onto roof or bumper.
- Baja Designs XL Sport LED Lights and Baja Designs Squadron Sport LED Lights.

<b>Baja Designs Light Power Cable</b> <i>(Not illustrated)</i>	Commander, Commander MAX, Maverick Trail, Maverick Sport, Maverick Sport MAX	<b>715007049</b>	<b>\$117.49</b>
---	---	------------------	-----------------

- Required for installation of Baja Designs LED lights onto roof or bumper.
- 10" (25 cm) Baja Designs OnX6 LED Bars and Baja Designs XL80 LED Lights.

# AUDIO & COMMUNICATION SYSTEMS

## AUDIO

<b>Can-Am Audio Roof</b>	Commander, Maverick Trail, Maverick Sport	<b>715006309</b>	<b>\$3,919.99</b>
	<ul style="list-style-type: none"> <li>• Full roof with premium JL Audio system for Commander.</li> <li>• Fully sealed and waterproof components and construction.</li> <li>• Simple to install: one connector connects the roof to the vehicle's electrical system.</li> <li>• Weatherproof components: Four 7.7" coaxial speakers, 280 watt amplifier and Mediamaster® source unit.</li> <li>• AM/FM tuner.</li> <li>• Expertly tuned for exceptional sound on the move in your Commander.</li> <li>• Speakers include adjustable RGB LED cone illumination, controlled via an app on your smartphone.</li> <li>• Mediamaster® source unit equipped with 3" full-color LCD display, with day/night lighting modes.</li> <li>• Designed to not drain the battery.</li> <li>• Compatible with 39 in. (99 cm) Double Stacked LED Light Bar (270 W) (715004007).</li> <li>• Not compatible with Adventure Roof Rack or Overhead Switch Panel.</li> </ul>		
<b>Can-Am Audio Roof MAX</b>	Commander MAX, Maverick Sport MAX	<b>715006842</b>	<b>\$4,949.99</b>
	<ul style="list-style-type: none"> <li>• Full roof with premium JL Audio system for Commander MAX.</li> <li>• Fully sealed and waterproof components and construction.</li> <li>• Simple to install: one connector connects the roof to the vehicle's electrical system.</li> <li>• Weatherproof components: Six 7.7" coaxial speakers, 280 watt amplifier and Mediamaster® source unit</li> <li>• AM/FM tuner.</li> <li>• Expertly tuned for exceptional sound on the move in your Commander MAX.</li> <li>• Speakers include adjustable RGB LED cone illumination, controlled via an app on your smartphone.</li> <li>• Mediamaster® source unit equipped with 3" full-color LCD display, with day/night lighting modes.</li> <li>• Designed to not drain the battery.</li> <li>• Compatible with 39 in. (99 cm) Double Stacked LED Light Bar (270 W) (715004007).</li> <li>• Not compatible with Adventure Roof Rack.</li> </ul>		
<b>Can-Am Audio Roof Flip Kit</b>	Commander, Commander MAX, Maverick Trail, Maverick Sport, Maverick Sport MAX	<b>715007228</b>	<b>\$641.99</b>
	<ul style="list-style-type: none"> <li>• Combines with the Can-Am JL Audio Roof (715006309 or 715006842) for Flip option.</li> <li>• Not compatible with the Roof Rack.</li> </ul>		
<b>Complete Wet Sounds<sup>†</sup> Audio System</b>	Commander, Commander MAX, Maverick Trail, Maverick Sport, Maverick Sport MAX	<b>715003672</b>	<b>\$1,029.99</b>
	<ul style="list-style-type: none"> <li>• Orchestrated for outstanding sound quality and the playlists of champions.</li> <li>• Built-in 200 W amplifier with D-Bass Tech for improved low end bass response.</li> <li>• Built-in Bluetooth<sup>†</sup> connectivity with source control.</li> <li>• Aux input allows for use with non-Bluetooth devices.</li> <li>• Turns itself off after 10 minutes of inactivity to save battery power.</li> <li>• Designed to be Can-Am-tough in the most demanding riding conditions.</li> <li>• Includes 4.5" (11.4 cm) front and 6.5" (16.5 cm) rear-roll-cage mounted stereo speakers and console integrated backlit control panel.</li> </ul>		
<b>Wetsound Stealth XT 6 Can-Am Edition Sound Bar</b>	Commander, Commander MAX, Maverick Trail, Maverick Sport, Maverick Sport MAX	<b>715008282</b>	<b>\$823.99</b>
	<ul style="list-style-type: none"> <li>• Built-in Bluetooth connectivity with source control.</li> <li>• Built-in Broadcast mode.</li> <li>• Backlit control panel with Integrated LED RGB cabin lights.</li> <li>• Integrated LED Dome.</li> <li>• IP67 rated RF wireless remote control.</li> <li>• 3.5 aux input/output.</li> <li>• Built-in 300 W Class D amplifier.</li> <li>• 4 marine-rated 3" full range drivers.</li> <li>• 2 marine-rated 1" tweeters.</li> <li>• Operating voltage: 12 V.</li> <li>• IP rated: IP67.</li> <li>• Length: 21.31"</li> <li>• Width: 4.04'</li> <li>• Height: 3.85"</li> <li>• Sound Bar Mounting Kit required for installation.</li> </ul>		
<b>Sound Bar Mount Kit</b> <i>(Not illustrated)</i>	Commander, Commander MAX, Maverick Trail, Maverick Sport, Maverick Sport MAX	<b>715004745</b>	<b>\$104.49</b>
<ul style="list-style-type: none"> <li>• Required mount kit for the Wet Sounds Stealth 6 Ultra HD Can-Am Edition Sound Bar (715008282).</li> </ul>			

<b>Can-Am Subwoofer</b>	Commander, Commander MAX, Maverick Trail, Maverick Sport, Maverick Sport MAX	<b>715006359</b>	<b>\$812.99</b>
-------------------------	--	------------------	-----------------



- Powerful Wet Sounds 8" Subwoofer speakerbox that fits in the glove box.
- Easy plug-and-play connections to Wet Sounds audio system.
- Sturdy construction, tough enough to withstand harsh environments and sealed against moisture and dirt.
- 350 W amplifier and wiring included.

<b>Electronic Device Holder</b>	Commander, Commander MAX, Maverick Trail, Maverick Sport, Maverick Sport MAX	<b>715005212</b>	<b>\$212.99</b>
---------------------------------	--	------------------	-----------------



- A great in-ride entertainment system platform.
- Robust injected-polypropylene construction allows for right fit and easy installation.
- Adjustable unit safely holds most tablets and smartphones measuring between 5.1" (13 cm) and 10" (25.4 cm) (with protective case).
- Allows the installation of Garmin Montana 680T GPS.
- Perfectly complements the Wet Sounds audio systems or Rugged Radios Intercom System to play music with your device.
- Integrated storage (2.5 gal (9.5 L) capacity) with access to the dash 12V outlet for device charging.
- Integrated mounting location for RAM mounts.
- Not compatible with Defrost, Heat and Ventilation System (715003678).

# ELECTRICAL & ELECTRONIC ACCESSORIES

## ELECTRICAL

<b>Defrost, Heat and Ventilation System</b>	Commander, Commander MAX, Maverick Trail, Maverick Sport, Maverick Sport MAX	<b>715003678</b>	<b>\$1,187.99</b>
---	--	------------------	-------------------



- Best integrated system on the market with 3 ventilation speeds and in-dash adjustable temperature.
- Adjustable/directional vents.
- 5 vents specially positioned for better windshield defrosting and passenger comfort.
- Automotive-style heater core and fan for best heating performance.
- Smart-Lok™ equipped vehicles require Adapter Kit (715007241).
- Not compatible with the ProVent Windshield.

<b>Heated Grab Bar Cover</b>	Commander, Commander MAX, Maverick Trail, Maverick Sport, Maverick Sport MAX	<b>715004500</b>	<b>\$259.99</b>
------------------------------	--	------------------	-----------------



- Made tough to hold up to the stresses of rough riding, this heated cover will keep your passenger's hands warm and securely gripped during long, cold outings.
- Easy to install and remove.
- This kit includes the heated grab bar cover and in-dash switch.
- Heated Accessories Wiring Harness (710005757) is required.
- Draws a maximum of 25 W and 1.8 A at 13.5 W.

<b>Seat Heater</b>	Commander, Commander MAX, Maverick Trail, Maverick Sport, Maverick Sport MAX	<b>715006112</b>	<b>\$144.99</b>
--------------------	--	------------------	-----------------

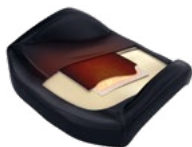

- 25 W seat heater delivers chill-free riding comfort.
- High/low temperature settings allow you to control the desired degree of warmth.
- This kit includes one carbon fiber seat heater, foam sheet and in-dash switch.
- Installs directly in the original seat cushion.
- Heated Accessories Wiring Harness (710005757) is required for front seat installation.
- Heated Accessories Wiring Harness (715006004) is required for rear seat installation.

<b>Heated Visor Outlet</b>	Commander, Commander MAX, Maverick Trail, Maverick Sport, Maverick Sport MAX	<b>715001246</b>	<b>\$60.99</b>
----------------------------	--	------------------	----------------



- Strategically positioned on vehicle to maintain your agility.
- Optional visor outlet that delivers fog-free riding.
- Quick and easy installation.
- Sold individually.
- Heated Visor not included.

<b>Heated Accessories Wiring Harness</b> <i>(Not illustrated)</i>	Commander, Commander MAX, Maverick Trail, Maverick Sport, Maverick Sport MAX	<b>710005757</b>	<b>\$127.99</b>
• Electric harness required to hook up and operate front heated seats, heated steering wheel and heated grab bar.			
<b>Heated Accessories Wiring Harness</b> <i>(Not illustrated)</i>	Commander MAX, Maverick Sport MAX	<b>715006004</b>	<b>\$189.99</b>
• Electric harness required to hook up and operate rear heated seats.			
<b>Heater Adapter Kit for Smart-Lok</b> <i>(Not illustrated)</i>	Commander, Commander MAX, Maverick Trail, Maverick Sport, Maverick Sport MAX	<b>715007241</b>	<b>\$154.99</b>
• Adapter kit to fit heating system on Smart-Lok equipped vehicles.			

## ELECTRONIC

<b>Cellphone Holder</b>	Commander, Commander MAX, Maverick Trail, Maverick Sport, Maverick Sport MAX	<b>715008786</b>	<b>\$106.99</b>
	<ul style="list-style-type: none"> <li>• Water resistant door allows for perfect phone positioning.</li> <li>• Features capacitive and resistive touch screen technology.</li> <li>• Spring system in back plate automatically adjusts for thickness.</li> <li>• Fits all cellphones within 7.2" (185 mm) x 3.3" (85 mm) x 0.6" (15 mm) dimensions.</li> <li>• Works with almost all charger wires.</li> <li>• Does not include cellphone or charging wires.</li> <li>• Requires the RAM GPS Mount (715003325) bolted directly on the dashboard for the Cellphone Holder to be supported. RAM GPS Mount (715003325) can also be installed on the Electronic Device Holder (715005212).</li> </ul>		
<b>RAM<sup>†</sup> GPS Mount</b>	Commander, Commander MAX, Maverick Trail, Maverick Sport, Maverick Sport MAX	<b>715003325</b>	<b>\$70.99</b>
	<ul style="list-style-type: none"> <li>• Allows for GPS integration onto vehicle.</li> <li>• Standard AMPS hole pattern for Garmin Cradle.</li> </ul>		
<b>Overhead Switch Panel</b>	Commander, Commander MAX, Maverick Trail, Maverick Sport, Maverick Sport MAX	<b>715003669</b>	<b>\$267.49</b>
	<ul style="list-style-type: none"> <li>• Fully integrated Overhead Switch Panel gives additional switch spots for electrical accessories.</li> <li>• Required for Can-Am lights installation on the roof and for other top-mounted electrical accessories.</li> <li>• Optional for Baja Designs lights.</li> <li>• Requires Sport Roof or Bimini Roof with Sun Visor for installation.</li> </ul>		
<b>30 Ah Battery Holder</b>	Commander, Commander MAX, Maverick Trail, Maverick Sport, Maverick Sport MAX	<b>715004431</b>	<b>\$62.99</b>
	<ul style="list-style-type: none"> <li>• Fixation plate designed to hold the 30 Ah Battery (515176151).</li> <li>• 30 Ah battery sold separately.</li> </ul>		
<b>Quick Connect Battery Cable</b>	Commander, Commander MAX, Maverick Trail, Maverick Sport, Maverick Sport MAX	<b>715005408</b>	<b>\$11.07</b>
	<ul style="list-style-type: none"> <li>• Quickly and easily connect and charge different batteries with your charger.</li> <li>• Included in the Battery Charger/Maintainer.</li> <li>• Sold individually.</li> </ul>		
<b>Quick Connect Cable with Battery Indicator</b>	Commander, Commander MAX, Maverick Trail, Maverick Sport, Maverick Sport MAX	<b>715006055</b>	<b>\$23.99</b>
	<ul style="list-style-type: none"> <li>• Quickly and easily connect and charge different batteries with your charger.</li> <li>• 3-color LED indicator provides constant battery health indication.</li> <li>• Sold individually.</li> </ul>		

<b>Digitally Encoded Security System (D.E.S.S.™) Keys</b>	Commander 2023 & prior, Maverick Trail 2023 & prior (with 700 engine), Maverick Trail and Sport (with 1000/1000R engine)	<b>715002458</b>	<b>\$84.99</b>
---	--	------------------	----------------



- Top-security anti-theft protection for your vehicle.
  - Encrypted chip technology restricts access to your vehicle's electronic ignition system.
  - One vehicle/one code.
  - A vibration/shock-resistant ball-and-socket design that ensures a reliable connection.
- 3 programmable modes:
    - Work mode: Limits vehicle speed to 40 kph (25 mph) but does not limit engine torque. Maverick Trail (with 700 engine) and Commander: Configurable vehicle speed limit between 20 km/h (13 mph) and 100 km/h (60mph) that does not limit engine torque.
    - Normal mode: configurable, limits vehicle speed to 70 km/h (44 mph) and may have torque reduction.
    - Performance mode: No restrictions.

<b>Digitally Encoded Security System (D.E.S.S.) Keys</b>	Maverick Trail 2024 & up (with 700 engine)	<b>715009300</b>	<b>\$84.99</b>
--	--	------------------	----------------



- Top-security anti-theft protection for Can-Am vehicles.
  - The encrypted chip technology restricts access to the unit's electronic ignition system.
  - One code per vehicle.
  - Features a vibration/shock-resistant ball-and-socket design that ensures a reliable connection.
- Comes with three programmable keys, including:
    - Work mode: Configurable vehicle speed limit between 20 km/h (13 mph) and 100 km/h (60mph) that does not limit engine torque.
    - Normal key: Configurable limits vehicle speed to 70 km/h (44 mph) and may have torque reduction
    - Performance key: No restrictions.

<b>Digitally Encoded Security System (D.E.S.S.) Green Key</b>	Commander, Commander MAX (2024 & up)	<b>710005232</b>	<b>\$63.49</b>
---	--------------------------------------	------------------	----------------



- Top-security anti-theft protection for your vehicle.
  - Encrypted chip technology restricts access to your vehicle's electronic ignition system.
  - One vehicle/one code.
  - A vibration/shock-resistant ball-and-socket design that ensures a reliable connection.
- 3 programmable modes:
    - Work mode: configurable vehicle speed limit between 20 km/h (13 mph) and 100 km/h (60 mph) that does not limit engine torque.
    - Normal mode: configurable, limits vehicle speed to 70 km/h (44 mph) and may have torque reduction.
    - Performance mode: no restrictions.

# WINCHES & HITCHES

## CAN-AM HD WINCHES

<b>Can-Am HD 4500 Winch</b>	Commander, Commander MAX, Maverick Trail, Maverick Sport, Maverick Sport MAX	<b>715006416</b>	<b>\$384.99</b>
-----------------------------	--	------------------	-----------------



- Ergonomic clutch handle.
  - Rugged all-steel gears and bushings for more torque and durability.
  - Automatic 100% load-holding brake.
  - Sealed solenoid for all-weather protection.
  - Weather sealed corded remote and dash mounted switch.
  - EC compliant.
- Pulling strength capability of 4,500 lb (2,041 kg).
  - 43' of 1/8" (13.1 m of 6.3 mm) wire steel cable.
  - Heavy-duty 4-way roller fairlead.
  - Winch Electrical Harness (715003777) is required for installation.
  - Commander X mr front bumper requires Winch Electrical Harness (715008218).

<b>Can-Am HD 4500-S Winch</b>	Commander, Commander MAX, Maverick Trail, Maverick Sport, Maverick Sport MAX	<b>715006417</b>	<b>\$513.49</b>
-------------------------------	--	------------------	-----------------



- Ergonomic clutch handle.
  - Rugged all-steel gears and bushings for more torque and durability.
  - Automatic 100% load-holding brake.
  - Sealed solenoid for all-weather protection.
  - Weather sealed corded remote and dash mounted switch.
- Pulling strength capability of 4,500 lb (2,041 kg).
  - 50' of 1/4" (15.2 m of 6.35 mm) synthetic rope.
  - Corrosion-proof aluminum Hawse fairlead.
  - Winch Electrical Harness (715003777) is required for installation.
  - Commander X mr front bumper requires Winch Electrical Harness (715008218).

## WINCH ACCESSORIES

<b>NEW Winch Cable Stopper</b>	All Can-Am HD Winches	<b>715009921</b>	<b>\$21.29</b>
	<ul style="list-style-type: none"> <li>• Made of EPDM, a highly durable synthetic rubber.</li> <li>• The Winch Cable Stopper isn't just for looks. It helps extend the life of the winch, rope, hook, and fairlead.</li> <li>• In addition, the split design makes it easy to install.</li> </ul>		
<b>Can-Am HD Hawse Fairlead</b>	Can-Am HD Winch	<b>715006426</b>	<b>\$61.49</b>
	<ul style="list-style-type: none"> <li>• A must when upgrading your winch with a synthetic cable, this corrosion-proof aluminum Hawse fairlead will prevent the cable from snapping in a corner of a roller fairlead and from wearing prematurely due to the rough surface of the worn roller guide.</li> <li>• Must be used with synthetic cables only.</li> </ul>		
<b>Roller Fairlead</b>	Can-Am HD Winch	<b>710007082</b>	<b>\$59.49</b>
	<ul style="list-style-type: none"> <li>• Suggested when changing the wire rope.</li> <li>• Heavy-duty replacement fairlead for winches.</li> </ul>		
<b>Synthetic Winch Cable</b>	Can-Am HD Winch	<b>715006430</b>	<b>\$158.99</b>
	WARN Winch	<b>715007783</b>	<b>\$169.99</b>
	<ul style="list-style-type: none"> <li>• 50' of ¼" (15.2 m of 6.35 mm) synthetic cable for Can-Am HD winches.</li> <li>• Can-Am HD Hawse Fairlead (715006426) is required when upgrading to a synthetic cable to avoid premature cable damage and wear.</li> <li>• WARN Hawse Fairlead (715007785) is required when upgrading to a synthetic cable to avoid damage and premature wear of the cable.</li> </ul>		
<b>Wire Rope Replacement</b>	Can-Am HD Winch	<b>705014978</b>	<b>\$23.99</b>
	WARN Winch	<b>715006699</b>	<b>\$82.99</b>
	<ul style="list-style-type: none"> <li>• 43' of 1/8" (14.3 m of 6.3 mm) wire rope for Can-Am HD Winch.</li> <li>• 55' of ¼" (16.8 m of 6.35 mm) wire rope for WARN winch kit.</li> <li>• 4,500 lb (2,041 kg) pulling strength.</li> </ul>		
<b>Synthetic Cable Extension</b>	<b>715001120</b>	<b>\$174.99</b>	
	<ul style="list-style-type: none"> <li>• Lightweight ¼" (6.35 mm) diameter, easy to handle and won't rattle in cargo box.</li> <li>• Easily attaches to winch cable to provide additional 50' (15.2 m) of distance.</li> <li>• 4,500 lb (2,041 kg) single line capacity.</li> </ul>		
<b>NEW Wireless Winch Remote</b>	With Can-Am HD Winch	<b>715008286</b>	<b>\$159.74</b>
	<ul style="list-style-type: none"> <li>• On/Off and Winch In / Winch Out buttons with LED indicator light.</li> <li>• Large Winch In / Winch Out buttons for easy activation with gloves.</li> <li>• Ergonomic remote handle shape with a trigger-like holding protrusion.</li> <li>• Quick and easy to install, thanks to a wiring harness with an integrated antenna and all necessary mounting hardware.</li> <li>• Allows you to operate your winch from anywhere within a 50' (15.2 m) radius, increasing your recovery options.</li> <li>• All components are IP67 sealing rated.</li> <li>• The remote also floats in case it's dropped during a deep water recovery.</li> <li>• Dash and handlebar mounting options.</li> <li>• Compatible with all Can-Am HD winches.</li> </ul>		
<b>Wired Remote Control</b>	Can-Am HD Winch	<b>715006504</b> (2020 & up)	<b>\$26.49</b>
	<ul style="list-style-type: none"> <li>• This kit allows winch owners to add the hand-held remote to vehicles with a stock winch.</li> <li>• OEM stock winch and Wired Remote Control are sold separately.</li> <li>• EC compliant.</li> </ul>		

## HITCHES

<b>NEW Trailer Hitch Ball Mount</b>	Commander, Commander MAX	<b>715010023</b>	<b>\$85.19</b>
-------------------------------------	--------------------------	------------------	----------------



- Designed to fit trailer hitches with a 2" x 2" (5 cm x 5 cm) receiver tube opening.
- It offers 3,500 lb (1,590 kg) of towing capacity.
- Solid forged steel construction.
- Equipped with a hole to accept a 3/4" (1.9 cm) ball shank.
- 1" (2.5 cm) raised or 2" (5 cm) lowered for precise trailer leveling.
- Hitch ball not included.

### Front Receiver Hitch

Commander, Commander MAX,  
Maverick Trail, Maverick Sport,  
Maverick Sport MAX

**715003642**

**\$148.99**



- Heavy-duty 1,500 lb (680 kg) towing capacity 2" (5 cm) receiver hitch.
- Perfect for precision towing in small spaces.

# PERFORMANCE

### Performance Half Shaft

Maverick Trail

**705402423**

Maverick Sport, Maverick Sport MAX

**705402281**

**\$243.99**



- High-performance design ideal for off-road use, with superior protection in any riding usage.
- Includes CVs, shaft and boots with the best suited geometry for your Can-Am vehicle.
- Required to install the Smart-Lok Differential Kit.

### Mud Smart Mode Module

*(Not illustrated)*

Models with Smart-Lok Differential

**715005282**

**\$191.49**

- This module allows you to add the Mud Smart Mode to vehicles with the Smart-Lok Differential Kit sold as an accessory or to change to the Mud Smart Mode on vehicles equipped with a standard Smart-Lok.
- The Mud Mode has been specially designed to deliver superior traction in the deepest mud holes.
- When high engine torque and/or slippage is detected, Smart-Lok will fully lock the front end.
- The system will stay locked until throttle release.
- Only one Smart Mode Module can be installed at a time.

### Rock Smart Mode Module

*(Not illustrated)*

Models with Smart-Lok Differential

**715005283**

**\$191.49**

- This module allows you to add the Rock Smart Mode to vehicles with the Smart-Lok Differential Kit sold as an accessory or to change to the Rock Smart Mode on vehicles equipped with a standard Smart-Lok.
- The Rock Mode has been specially designed to help cross challenging rocks.
- When high engine torque is detected at low vehicle speed, Smart-Lok will progressively lock the front end and will stay engaged until throttle release to prevent wheel slippage and provide optimal traction.
- The progressive engagement allows for easier steering when maneuvering the vehicle.
- Only one Smart Mode Module can be installed at a time.

### Trail Activ Smart Mode Module

*(Not illustrated)*

Models with Smart-Lok Differential

**715005284**

**\$191.49**

- This module allows you to add the Trail Activ Smart Mode to vehicles with the Smart-Lok Differential Kit sold as an accessory or to change to the Trail Activ Smart Mode on vehicles equipped with a standard Smart-Lok.
- The Trail Activ Mode has been designed for aggressive riding, delivering the ultimate cornering precision.
- When high engine torque and/or an increase in vehicle speed is detected, Smart-Lok will progressively engage the front end and keep it engaged until throttle release or vehicle speed reduction.
- The progressive engagement allows for smoother and lower steering effort.
- Only one Smart Mode Module can be installed at a time.

## EXHAUST AND AIR INTAKE

<b>Yoshimura† Slip-On Exhaust</b>	Maverick Sport, Maverick Sport MAX (models with 1000R engine)	<b>715004452</b>	<b>\$1,329.99</b>
-----------------------------------	---	------------------	-------------------



- Developed in collaboration with Yoshimura.
- Made from 304-grade stainless steel.
- Sporty sound from a lighter-than-stock muffler.
- USDF/USDA approved spark arrester.
- EPA compliant.
- Not EC compliant.

<b>Performance Air Filter by Twin AIR†</b>	Commander, Commander MAX, Maverick Trail, Maverick Sport, Maverick Sport MAX (models with 1000R engine)	<b>715002895</b>	<b>\$116.49</b>
	Maverick Trail, Maverick Sport (except models with 1000R engine)	<b>715003630</b>	<b>\$126.99</b>



- The best choice for the harshest conditions.
- Multiple staged oiled filtering foam for superior dust retaining capacity with high airflow.
- Washable and reusable.

<b>Engine and CVT Pre-Filter Kit</b> <i>(Not illustrated)</i>	Commander, Commander MAX, Maverick Trail, Maverick Sport, Maverick Sport MAX	<b>715004290</b>	<b>\$95.49</b>
--	--	------------------	----------------

- Adds extra protection to your engine and CVT in harsh riding conditions.
- Filter blocks particles larger than 0.005" (0.1 mm).
- Water repellent screen.
- Mandatory to maintain the vehicle's warranty when tracks are installed.
- Recommended for winter riding conditions.
- Not compatible with Snorkel Kit.
- Not compatible with Adventure Roof Rack.

<b>Snorkel Pre-Filter</b>	Commander, Commander MAX, Maverick Trail, Maverick Sport, Maverick Sport MAX	<b>715005598</b>	<b>\$132.49</b>
---------------------------	--	------------------	-----------------



- Pre-filter specifically for snorkels.
- Adds extra protection to your engine in harsh riding conditions.
- Helps keep air filter cleaner.
- Filter blocks particles larger than 0.005" (0.13 mm).
- Mandatory to maintain vehicle warranty when tracks are installed.

<b>Snorkel Kit</b>	Commander, Commander MAX (except 700 engines), Maverick Trail (except 700 engines), Maverick Sport, Maverick Sport MAX	<b>715003705</b>	<b>\$595.99</b>
--------------------	--	------------------	-----------------



- Raises point of engine and CVT air intakes so vehicle can be semi-submersed in water/mud without taking in water to the engine.
- Not compatible with S&B Particle Separator, LinQ Pivoting Rack, Lonestar Racing Rear Intrusion Bar and all rear panels and windows.
- Standard on Maverick Sport and Commander X mr models.
- Not EC compliant.

<b>Heavy-Duty Spring Kit</b>	Maverick Trail	<b>715004961</b>	<b>\$393.99</b>
------------------------------	----------------	------------------	-----------------



- This set of heavy-duty springs will stiffen your suspension.
- Perfect for reducing vehicle overall sag when shocks are under heavy demand: heavy loading and hauling or for snow clearing.
- Complete kit of 4 springs.

<b>Shock Covers</b> <i>(Not illustrated)</i>	Maverick Sport, Maverick Sport MAX	<b>715002368</b>	<b>\$44.49</b>
---	------------------------------------	------------------	----------------

- Soft covers for shocks with ventilation holes.
- Eliminate dust and dirt intrusion into the shock cylinder, reducing risk of damage.
- Sold in pairs.

## EMERGENCY ACCESSORIES

<b>Emergency Kit</b>	Commander, Commander MAX, Maverick Trail, Maverick Sport, Maverick Sport MAX	<b>715006102</b>	<b>\$170.49</b>
----------------------	--	------------------	-----------------



- Complete emergency kit provides all essential equipment and supplies to get out of most unfavorable situations powersport enthusiasts can find themselves in.
- Includes: Jumper Cables, Air Compressor, Tire Repair Kit, Ratchet Tie-Down, Duct Tape, Tow Strap 3,300 lb (1,500 kg), Zip Ties, Cloth Rags.

No traction? No problem. Apache XC LT Tracks are built for serious terrain. With improved flotation and stability, they tackle deep snow, mud, and everything in between. Engineered for optimized attack angles, reduced noise, and unmatched durability, this system means all-season dominance.

# DESIGNED FOR PEAK PERFORMANCE

Aggressive lugs deliver max traction without sacrificing handling. A reinforced steel frame boosts strength, while the center slide improves alignment and reduces de-tracking. Reduced NVH levels and the wheel placement ensure smooth, quiet power delivery. Plus, wheel longevity is increased with replaceable wheel bearings.







## APACHE TRACK SYSTEMS

APACHE XC LT		LIMITED WARRANTY*	
<b>Apache XC LT Track System</b>	Maverick Trail, Maverick Sport, Maverick Sport MAX, Commander, Commander MAX	<b>715007719</b>	<b>\$6,899.99</b>
 <ul style="list-style-type: none"> <li>• Long Track version.</li> <li>• Brand-new track design to optimize driving off and in deep snow conditions.</li> <li>• Reduction in steering effort thanks to the tandem 4 wheels.</li> <li>• Vibrations are reduced due to the alignment of the wheels with the rolling band of the track and the shaft damper mounted tandem.</li> <li>• Better steering precision because of this wheel and track alignment due to good ground contact.</li> <li>• 1.25" (3.175 cm) lugs in the front and in the back for better traction and lateral stability.</li> <li>• Track width: front 12.5" and rear 15".</li> <li>• Adds 3" (7.62 cm) of ground clearance versus 27" tires.</li> </ul>	<ul style="list-style-type: none"> <li>• Additional shaft dampers, tandem dampers, track design and wheel layout significantly reduce NVH (noise vibration harshness).</li> <li>• Central guide for optimized track alignment and reduced occurrences of detacking.</li> <li>• Optimized track layout with increased angle of attack for better obstacle crossing and snow performance.</li> <li>• Stamped and welded steel frame for improved strength and durability.</li> <li>• Easy maintenance with replaceable hub and wheel bearings.</li> <li>• Main hub is oil bath with 3 bearings inside for consistent lubrication.</li> <li>• DPS module and engine and CVT pre-filter required.</li> <li>• Mounting kit sold separately.</li> </ul>		
<b>Apache XC LT Mounting Kit</b> <i>(Not illustrated)</i>	See table for fit, compatibility and requirements.	<b>715008611</b> <b>715008612</b> <b>715008613</b>	<b>\$701.99</b>
<ul style="list-style-type: none"> <li>• Required for installation of the Apache XC LT Track System.</li> <li>• Track DPS Module and Pre-Filter not included.</li> </ul>			

\*The limited warranty is subject to the exclusions, limitations of liabilities and all other terms and conditions of BRP's standard limited warranty.

## WINTER TRACKS

## LIMITED WARRANTY\*

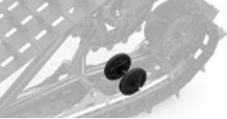
<b>Apache Backcountry Track System</b>	See table for specific models	<b>715005247</b>	<b>\$6,749.99</b>
	<ul style="list-style-type: none"> <li>• Designed to deliver the best flotation level and deep-snow performance on the market.</li> <li>• Contact patch is 23% bigger than the Apache 360 LT.</li> <li>• Provides an impressive average ground clearance increase of 7" (18 cm), keeps the vehicle out of deep snow.</li> <li>• Aggressive track design with 2" (5 cm) lug height for maximum traction on snow.</li> <li>• Apache Backcountry Mounting Kit, Track DPS Module and Engine and CVT Pre-Filter are required.</li> <li>• For winter use only.</li> <li>• Track installation will affect vehicle width and length.</li> </ul>		
<b>Apache Backcountry LT Track System</b>	See table for specific models	<b>715005891</b>	<b>\$8,549.99</b>
	<ul style="list-style-type: none"> <li>• Tracks designed to deliver the best snow performance on the market with unmatched flotation level and traction on snow surface.</li> <li>• Large contact patch, 37% bigger than the Apache 360 LT.</li> <li>• Impressive added ground clearance of 7" (18 cm) helps keep the vehicle over the snow.</li> <li>• Lightweight snowmobile-inspired rail design.</li> <li>• Aggressive track design with 2" (5 cm) lug height for maximum traction on snow.</li> <li>• Apache Backcountry LT Mounting Kit, Track DPS Module, Engine and CVT Pre-Filter are required.</li> <li>• Fine-tune your track system using extra Idler Wheels, Sliders with Vespel Inserts and Rail Ice Scratcher.</li> <li>• For winter use only.</li> <li>• Track installation will affect vehicle width and length.</li> </ul>		
<b>Apache Backcountry Mounting Kit</b> <i>(Not illustrated)</i>	See table for specific models Maverick Trail	<b>715004834</b> <b>715004285</b>	<b>\$593.49</b>
<ul style="list-style-type: none"> <li>• Required for installation of the Apache Backcountry Track System.</li> <li>• Not compatible with HMWPE Front and Rear A-Arm Protectors and Skid Plates.</li> <li>• DPS Module and Pre-Filter not included.</li> </ul>			
<b>Apache Backcountry LT Mounting Kit</b> <i>(Not illustrated)</i>	See table for specific models	<b>715005493</b>	<b>\$593.49</b>
<ul style="list-style-type: none"> <li>• Required for installation of the Apache Backcountry Track LT System.</li> <li>• DPS Module and Pre-Filter are required and sold separately.</li> <li>• Not compatible with HMWPE Front and Rear A-Arm Protectors and Skid Plates.</li> </ul>			
<h2>ACCESSORIES</h2>			
<b>Track DPS Module</b> <i>(Not illustrated)</i>	Maverick Trail 2024 & up, Commander, Commander MAX 2024 & up Commander, Commander MAX, Maverick Trail, Maverick Sport	<b>715006266</b> <b>715007338</b>	<b>\$111.49</b>
<ul style="list-style-type: none"> <li>• Innovative DPS module that ensures speedometer accuracy and optimized steering assist which make for perfect track control and riding ease.</li> <li>• Required to install the Apache and Backcountry Track Systems.</li> </ul>			
<b>Rail Ice Scratchers</b>	Apache Backcountry and Apache Backcountry LT Track Systems	<b>860201728</b>	<b>\$127.99</b>
	<ul style="list-style-type: none"> <li>• Provide additional lubrication in hard and icy conditions.</li> <li>• Rail mounted, small, light.</li> <li>• Design expands on coil concept to allow reversing without damage.</li> <li>• Easily stored when not in use.</li> <li>• Extend slider life.</li> </ul>		
<b>Idler Wheel Kit</b>	Apache Backcountry Track System, rear tracks only	<b>860201230</b> 141 mm	<b>\$62.49</b>
	<ul style="list-style-type: none"> <li>• Reduces drag and rolling resistance.</li> <li>• Includes 2 wheels, brackets and hardware.</li> <li>• Add up to 2 kits per rear track.</li> <li>• Can extend slider life in hardened snow conditions.</li> </ul>		
<b>Apache Backcountry LT Wheel Kit</b>	Apache Backcountry and Apache Backcountry LT Track Systems	<b>715006293</b>	<b>\$111.49</b>
	<ul style="list-style-type: none"> <li>• Additional wheel kit for Backcountry LT rear tracks.</li> <li>• Reduces drag and rolling resistance in hard snow conditions or when transporting heavier loads.</li> <li>• Extends slider life in hard snow conditions.</li> <li>• Includes two wheels, cross shaft and mounting hardware per kit to service one track corner.</li> <li>• Up to two kits per rear track can be installed.</li> </ul>		

\*The limited warranty is subject to the exclusions, limitations of liabilities and all other terms and conditions of BRP's standard limited warranty.



- Use DuPont Vespel inserts for less friction.
- Longer life.
- Can be cut to desired length.
- 8 needed per vehicle.
- Sold individually.

## APACHE TRACK SYSTEMS FITTING GUIDE

### APACHE BACKCOUNTRY AND BACKCOUNTRY LT

Model Year / Model	Track	Track Mount	Track DPS Module	Prefilter without Snorkel	Prefilter with Snorkel
2018 & Up Maverick Trail, Maverick Trail DPS 1000	715005247	715004285	715007338	715004290	715005598
2018 to 2023 Maverick Trail: Base, DPS 700					
2021* & 2023 Commander: DPS, XT 700 Commander: MAX DPS, XT 700	715005247	715004834	715007338	715004290	715005598
2019 & Up Maverick Sport, Maverick Sport MAX (except X mr, X rc, X xc models)					
2021* & Up Commander, Commander MAX (except Commander DPS & Commander XT 700)	715005891	715005493			
2021* & Up Maverick Sport X mr, X rc, X xc					
2024 & Up Maverick Trail: Base, DPS 700	715005247	715004285	715006266		
2024 & Up Commander: DPS, XT 700 Commander MAX: DPS, XT 700		715004834			

\*For 2021 models produced after January 18, 2021.

### APACHE XC LT

Model Year / Model	Track	Track Mount	Track DPS Module	Prefilter without Snorkel	Prefilter with Snorkel
2018 to 2023 Maverick Trail	715007719	715008611	715007338	715004290	715005598
2021* to 2023 Commander: DPS, XT 700 Commander MAX: DPS, XT 700		715008613			
2019 & Up Maverick Sport, Maverick Sport MAX (except X mr, X rc, X xc models)	715007719	715008612	715007338	715004290	715005598
2021 & Up Commander, Commander MAX (except Commander DPS & Commander XT 700)					
2021* & Up Maverick Sport X mr, X rc, X xc					
2024 & Up Maverick Trail	715007719	715008611	715006266		
2024 & Up Commander: DPS, XT 700 Commander MAX: DPS, XT 700		715008613			

\*For 2021 models produced after January 18, 2021.

# BUILD A KIT THAT WORKS HARD.

Combine a mounting kit, push frame, and blade. Then, customize with accessories like the plow angling kit, blade extensions, or edge markers. Easy to install, engineered to last, and tough enough for brutal winter jobs—this lineup covers every plowing need.



## PROMOUNT PLOWS

### PROMOUNT PLOW KITS

REFERENCE CHART						
	66" Black Steel	66" Yellow Steel	72" Black Steel	72" Yellow Steel	66" Flex2	72" Flex2
Plow Kit	715010997	715008174	715010998	715008173	715010999	715011000
Blade	715009881	-	715009877	715006021	715009883	715009868
Push Frame	715010845	715010845	715010845	715010845	715010845	715010845
Mounting Plate	715007742	715007742	715007742	715007742	715007742	715007742

CAN-AM ProMount STEEL PLOW KITS			
<b>Can-Am ProMount Steel 66" (168 cm) Plow Kit</b>	Commander, Commander MAX, Maverick Trail, Maverick Sport, Maverick Sport MAX	■ 715010997 • Black	N/A
<b>Can-Am ProMount Steel 72" (183 cm) Plow Kit</b>	Commander, Commander MAX, Maverick Trail, Maverick Sport, Maverick Sport MAX	■ 715010998 • Black	N/A



- These kits include:
  - Can-Am ProMount Steel Blade
  - Push Frame with Quick-Attach System
  - Can-Am ProMount Mounting Plate

## CAN-AM ProMount STEEL BLADES

<b>Can-Am ProMount Steel 66" (168 cm) Blade</b>	Fits ProMount Push Frame	■ 715009881 • Black	<b>\$534.99</b>
---	--------------------------	---------------------	-----------------



- Plow blade made from 12-gauge steel.
- Replaceable wear blade.
- Large pin designed for easy blade rotation to eliminate snow buildup at pivot point.
- Blade design provides best snow roll-off at any angle.

- Clears 60" (152 cm) when plow is fully angled.
- Blade height of 17" (43 cm).
- Compatible with Can-Am ProMount Blade accessories to further enhance plow versatility.
- Not compatible with S3 High Clearance Front A-Arm.

<b>Can-Am ProMount Steel 72" (183 cm) Blade</b>	Fits ProMount Push Frame	■ 715009877 • Black	<b>\$609.99</b>
---	--------------------------	---------------------	-----------------



- Plow blade made from 12-gauge steel.
- Replaceable wear blade.
- Large pin designed for easy blade rotation to eliminate snow buildup at pivot point.
- Blade design provides best snow roll-off at any angle.

- Clears 66" (168 cm) when plow is fully angled.
- Blade height of 17" (43 cm).
- Compatible with Can-Am ProMount Blade accessories to further enhance plow versatility.
- Not compatible with S3 High Clearance Front A-Arm.

## CAN-AM ProMount ANGLE PLOWS

<b>Can-Am ProMount 66" (168 cm) Steel Oneway State Blade</b>	Fits ProMount Push Frame	715007263	<b>\$619.99</b>
--	--------------------------	-----------	-----------------

<b>Can-Am ProMount 72" (183 cm) Steel Oneway State Blade</b>	Fits ProMount Push Frame	715009879	<b>\$705.99</b>
--	--------------------------	-----------	-----------------



- Make the job easier with the right tools, clear long alleys and make the task easier by sending the snow further out of the way.
- Wing end of plow measures 26" (67 cm) high and tapers down to 16" (41 cm).
- One-way "winged" state plow designed to throw snow higher.
- Rubber Flap (715007299) designed to keep snow away from the driver is offered as accessory (sold separately).
- Can-Am branded.

## CAN-AM ProMount FLEX2 PLOW KIT

<b>Can-Am ProMount Flex2 66" (168 cm) Plow Kit</b>	Commander, Commander MAX, Maverick Trail, Maverick Sport, Maverick Sport MAX	715010999	N/A
--	--	-----------	-----

<b>Can-Am ProMount Flex2 72" (183 cm) Plow Kit</b>	Commander, Commander MAX, Maverick Trail, Maverick Sport, Maverick Sport MAX	715011000	N/A
--	--	-----------	-----



- These kits include:
  - Can-Am ProMount Flex2 Blade
  - Push Frame with Quick-Attach System
  - Can-Am ProMount Mounting Plate

## CAN-AM ProMount FLEX2 BLADES

<b>Can-Am ProMount Flex2 66" (168 cm) Blade</b>	Fits ProMount Push Frame	715009883	<b>\$598.99</b>
---	--------------------------	-----------	-----------------



- Plow blade made of UHMWPE, a flexible and impact absorbing material that prevents damaging your plow when accidental impact occurs.
- Replaceable wear blade.
- Large pin designed for easy blade rotation to eliminate snow buildup at pivot point.
- Blade design provides best snow roll-off at any angle.
- Clears 60" (152 cm) when plow is fully angled.
- Blade height of 17" (43 cm).
- Compatible with Can-Am ProMount Blade accessories to further enhance plow versatility.

<b>Can-Am ProMount Flex2 72" (183 cm) Blade</b>	Fits ProMount Push Frame	715009868	<b>\$684.99</b>
---	--------------------------	-----------	-----------------



- Plow blade made of UHMWPE, a flexible and impact absorbing material that prevents damaging your plow when accidental impact occurs.
- Replaceable wear blade.
- Large pin designed for easy blade rotation to eliminate snow buildup at pivot point.
- Blade design provides best snow roll-off at any angle.
- Clears 66" (168 cm) when plow is fully angled.
- Blade height of 17" (43 cm).
- Compatible with Can-Am ProMount Blade accessories to further enhance plow versatility.

## CAN-AM ProMount PLOW ACCESSORIES

<b>Can-Am ProMount Edge Markers</b>	Fits ProMount Plow Blades	<b>715004206</b>	<b>\$48.99</b>
-------------------------------------	---------------------------	------------------	----------------



- Help locate the edges of your plow.
- Height: 24" (60 cm).
- Sold in pairs.
- Recommended for Maverick Trail and Maverick Sport.
- Compatible with Can-Am ProMount Steel and Flex2 blades with or without Blade Extensions (except for the Can-Am ProMount Steel 54" (137 cm) Blades).

<b>Can-Am ProMount 66" (168 cm) Plastic Wear Blade</b>	Fits ProMount Plow Blades	<b>715004482</b>	<b>\$192.49</b>
--	---------------------------	------------------	-----------------

<b>Can-Am ProMount 72" (183 cm) Plastic Wear Blade</b>	Fits ProMount Plow Blades	<b>715004483</b>	<b>\$213.99</b>
--	---------------------------	------------------	-----------------



- Ideal to prevent leaving marks on your driveway.
- Compatible with Can-Am ProMount 72" (183 cm) Blades.

<b>Can-Am ProMount Drift Cutters</b>	Fits ProMount Plow Blades	<b>715006258</b>	<b>\$170.99</b>
--------------------------------------	---------------------------	------------------	-----------------



- Help keep snow in the plow.
- Dimensions: 17" x 13" (43.2 cm x 33 cm).
- Sold in pairs.
- Compatible with Can-Am ProMount Steel and Flex2 blades with or without Blade Extensions (except for the Can-Am ProMount Steel 54" (137 cm) Blades).

<b>Can-Am ProMount Blade Extensions</b>	Fits ProMount Plow Blades	<ul style="list-style-type: none"> <li>■ <b>715004205</b> - Black</li> <li>■ <b>715005319</b> - Yellow</li> </ul>	<b>\$128.49</b>
---	---------------------------	---	-----------------



- These conveniently extend your Can-Am ProMount Blade.
- Add 3" (8 cm) to each side.
- Compatible with Can-Am ProMount Blades (except for the Can-Am ProMount Steel 54" (137 cm) Blades).
- Longer wear blade can be installed to go over the extra length given by the extensions.

<b>Back Drag Blade</b> <i>(Not illustrated)</i>	Fits ProMount Plows (60" and more)	<b>715007794</b>	<b>\$299.49</b>
--	------------------------------------	------------------	-----------------

- ¼-in. thick steel swivel scraper.
- Lifts up when the vehicle is moving forward so as to not affect the scraping.
- Increased capacity to pull snow.
- More aggressive scraping in reverse mode.
- Lifts the scraper off the ground so that it scrapes evenly.
- Adjustable in length for compatibility with 60", 66" and 72" blades.
- Compatible with ProMount blades (Flex and Steel).

<b>Curved Wear Blade</b> <i>(Not illustrated)</i>	Fits ProMount Plow Blades	<ul style="list-style-type: none"> <li><b>715007792</b> - 66" (168 cm)</li> <li><b>715007793</b> - 72" (183 cm)</li> </ul>	<b>\$122.99</b>
--	---------------------------	--	-----------------

- Wear blade designed with a folded back bottom lip.
- The increased surface allows for less digging while plowing uneven surfaces.
- Ideal for snow covered gravel, grass, paver stone and other soft surfaces.

## CAN-AM ProMount CUSTOM SOLUTIONS

<b>Can-Am ProMount Push Frame with Quick-Attach System</b>	Commander, Commander MAX, Maverick Trail, Maverick Sport, Maverick Sport MAX	<b>715010845</b>	<b>\$534.99</b>
--	--	------------------	-----------------



- Heavy-duty steel tubes designed to withstand the roughest use.
- Mid-mount carriage provides ultimate push strength and traction.
- Allows 16" (41 cm) of plow lift on ATVs and 14" (36 cm) on Maverick Trail.
- Features a self aligning quick-attach system, an easy foot release pedal and an ergonomic handle for plow angle adjustment.

<b>Can-Am ProMount Push Frame Extension</b>	Commander, Commander MAX, Maverick Trail, Maverick Sport, Maverick Sport MAX	<b>715006257</b>	<b>\$186.99</b>
---	--	------------------	-----------------



- 12" (30 cm) push frame extension required when plow is installed with Apache Track systems.

<b>Plow Roller Fairlead</b>	Commander, Commander MAX, Maverick Trail, Maverick Sport, Maverick Sport MAX	<b>715001223</b> • Cylindrical Roller Fairlead	<b>\$87.49</b>
-----------------------------	--	---	----------------



- Larger diameter lower roller reduces wear on wire rope for plow application.
- Can be used with all ProMount plows.

<b>Can-Am ProMount Plow Angling System</b>	Commander, Commander MAX, Maverick Trail, Maverick Sport, Maverick Sport MAX	<b>715009657</b>	<b>\$641.99</b>
--	--	------------------	-----------------



- Converts your plow system into a unit that's easy to control from the driver's seat.
- Using one hand to control all plow motions will allow you to easily concentrate and manage your plowing tasks.
- Not compatible with Apache Backcountry LT Track System.
- Can-Am ProMount Push Frame (715010845) is required.
- Winch and plow sold separately.

<b>NEW Plow Quick Adjust Blade Shoes</b>	ProMount Steel & Flex2 Blades 60" (all years), 66" & 72" (2025 & prior)	<b>715009751</b>	<b>\$106.99</b>
--	---	------------------	-----------------



- Zinc-plated steel construction for corrosion resistance.
- Easy and quick tool-free adjustment.
- Pre-set adjustment for different heights.
- Larger shoe diameter for greater ground contact.
- Improved shoe design for better flotation.

<b>ProMount Plow Limit Switch</b>	Commander, Commander MAX, Maverick Trail, Maverick Sport, Maverick Sport MAX	<b>715006259</b>	<b>\$144.49</b>
-----------------------------------	--	------------------	-----------------



- For controlling the cable tension when over-raising your plow system.
- Prevents winch, plow push frame and vehicle damage.
- Sensor relocated for optimal lift height.

<b>Can-Am ProMount Mounting Plate</b>	Commander, Commander MAX, Maverick Trail, Maverick Sport, Maverick Sport MAX	<b>715007742</b>	<b>\$170.99</b>
---------------------------------------	--	------------------	-----------------



- Required to install the Can-Am ProMount Push Frame with Quick-Attach System.
- Mounting plate precision-designed to stay on year round without compromising ground clearance.
- Plow roller fairlead included.

# COVERS

<b>Trailer Cover</b>	Commander	<b>715006817</b>	<b>\$446.99</b>
	Commander MAX	<b>715007108</b>	<b>\$553.49</b>
	Maverick Trail, Maverick Sport	<b>715003706</b>	<b>\$436.49</b>



- Weather-resistant trailer cover protects your vehicle during storage and transportation.
- Heavy-duty canvas made of UV-resistant solution-dyed polyester.
- Inner soft liner protects windshield.
- All high-abrasion areas are reinforced with a double canvas layer.
- Opening for fuel cap.
- Quick and easy installation.
- Designed to perfectly fit your vehicle with or without Can-Am accessories except with Adventure Roof Rack and track kits.

# PARTS AND MAINTENANCE



# PARTS AND MAINTENANCE

How to use the EPC	214
Keep an Eye on These Parts	215
Air Filters	220
Oil Filters	220
Spark Plugs	221
Batteries	221
Axles	223
Ball Joint	225
Brake Pads	226
Belts	228
pDrive Maintenance Kits	228
QRS Rollers	228
XPS Tires	231
Lubricant & Oil Change Kit	233
Maintenance Products	234
Care Products	237

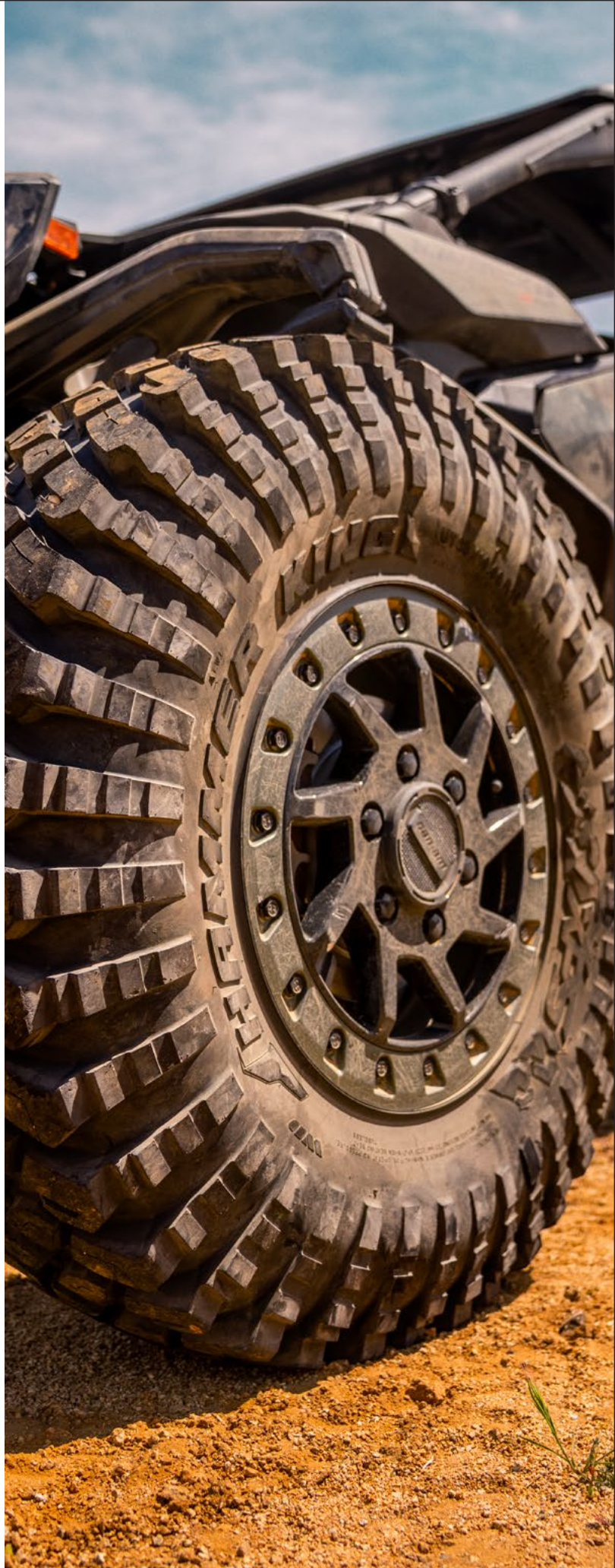



# BLENDING PERFORMANCE AND SAFETY

TRUST GENUINE CAN-AM PARTS  
TO KEEP YOUR VEHICLE PERFORMING  
AT ITS BEST.

## ONE-YEAR WARRANTY\*

- ✓ Precisely engineered.
- ✓ Rigorously tested.
- ✓ Factory approved.

\*Covers parts and labor when fitted at an authorized dealer.

# THE ELECTRONIC PARTS CATALOG (EPC)

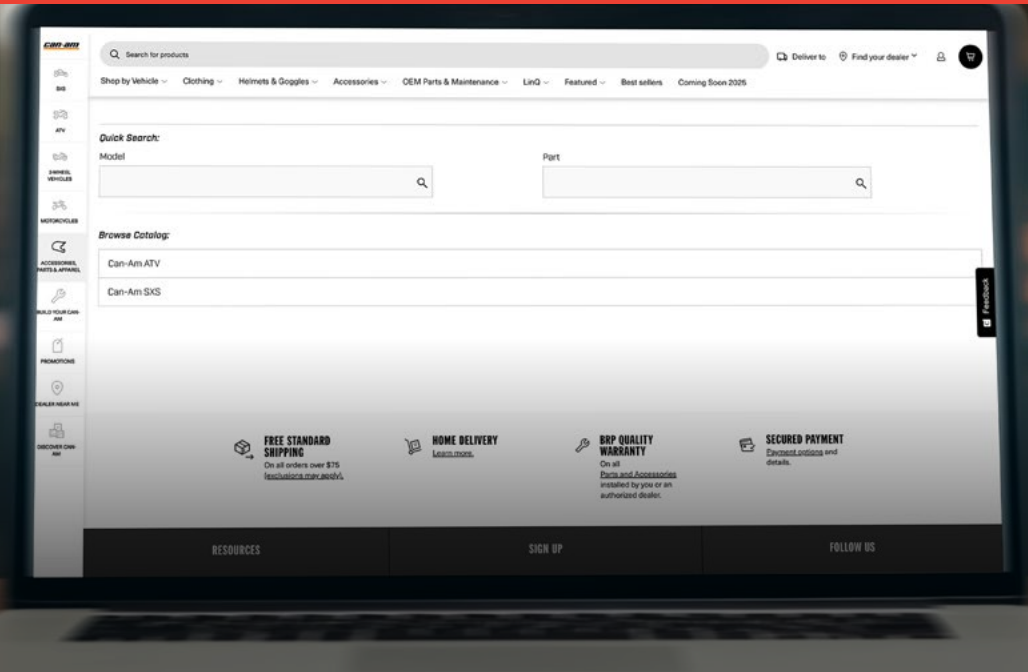

MAKES IT EASY TO LOCATE, IDENTIFY, AND ORDER EXACT-FIT PARTS. IT'S THE GO-TO RESOURCE FOR VIEWING THE FULL CAN-AM PART LINEUP, BUILT TO SAVE TIME AND ELIMINATE GUESSWORK.

## 3 SIMPLE STEPS TO FIND THE RIGHT PART

1

Select the exact vehicle model.

2

Choose the vehicle system needing a part.

3

Pick the part and add it to the cart. Search by part number or browse the full catalog.



SCAN THE QR CODE  
FOR INSTANT ACCESS  
TO THE EPC ON ECOM.

# CAN-AM DEFENDER G1



To make sure your Defender G1 performs as you expect, **keep an eye on these components.\*\***

## OIL FILTER 420256188

### ENGINE OIL

4T 10W-50 Synthetic Oil	1 quart / 946 ml	9779234
	1 US gallon / 3.785 L	9779235
4T 0W-40 Synthetic Oil	1 quart / 946 ml	9779139
	1 US gallon / 3.785 L	9779140
5W-40 Synthetic Oil	1 quart / 946 ml	9779492
	1 US gallon / 3.785 L	9779493

### OIL CHANGE KIT

5W-40 Synthetic Oil	500 cc or more V-twin engine	9779488
5W-40 Synthetic Oil	ACE 650 cc single cylinder	9779480
0W-40 Synthetic Oil	500 cc or more V-twin engine	9779259
0W-40 Synthetic Oil	ACE 650 cc single cylinder	9779481
10W-50 Synthetic Oil	500 cc or more V-twin engine	9779252
5W-40 Synthetic Oil	450 cc or less	9779487
0W-40 Synthetic Oil	450 cc or less	9779257

### TRANSMISSION OIL

Front Differential	32 oz / 0.946 L	9779158
75W-90 Gear Oil, Synthetic		
Gearbox	32 oz / 0.946 L	9779160
75W-140 Gear Oil, Synthetic		

### EMISSION CONTROL

Fuel Tank Vent Breather Filter Non-EVAP models		709001120
Canister Vent Pre-filter	CARB and EVAP models	709000524
Canister Fuel Filter	CARB and EVAP models	513034047

### AIR FILTER 715900394

### CVT AIR FILTER

HD9, HD10	706600419
-----------	-----------

### DRIVE BELT

HD10	Premium (Stock)	422280652
HD9	Premium (Stock)	422280656
HD7	Premium (Stock)	422280225
Performance (Upgrade)	See Reference Chart for upgrade	

### CLUTCH MAINTENANCE KITS

pDrive Ramp Rollers	Maintenance Kit	420629237
pDrive Torque Rollers	Maintenance Kit	420629224
QRS XD Roller Kit	Pack of 3	861805583

### BRAKE PAD KITS

Front Brake Pads (4 pads + hardware)	Defender (All models)	703501198
Rear Brake Pads (4 pads + hardware)	Defender	703501200
	HD7-HD9-HD10	
	Defender MAX-PRO-6X6	703501199

### CV BOOT KITS

Front Wheel Side	705401345
Front Differential Side	705401355
Rear	705501864

### WHEEL BEARINGS

	293350150
--	-----------

### FRONT A-ARM BUSHING KIT

	703500875
--	-----------

### BALL JOINTS

Lower	703501262
Upper	703501263

### SPARK PLUG

HD10	715900244
HD9	715901051
HD7	715900785

### BATTERY

18 aH Yuasa YTX20L fact. activated	410301203
30 aH Yuasa YIX30L fact. activated	515176151

\*\*Refer to periodic maintenance chart for proper intervals.

# CAN-AM DEFENDER G2



To make sure your Defender G2 performs as you expect,  
**keep an eye on these components.\*\***

## **OIL FILTER** 420956123

### **ENGINE OIL**

4T 10W-50 Synthetic Oil	1 quart / 946 ml	9779234
	1 US gallon / 3.785 L	9779235
4T 0W-40 Synthetic Oil	1 quart / 946 ml	9779139
	1 US gallon / 3.785 L	9779140
5W-40 Synthetic Oil	1 quart / 946 ml	9779492
	1 US gallon / 3.785 L	9779493

### **OIL CHANGE KIT**

5W-40 Synthetic Oil	Rotax 900/999 ACE	9779502
10W-50 Synthetic Oil	Rotax 900/999 ACE	9779503
0W-40 Synthetic Oil	Rotax 900/999 ACE	9779504

### **TRANSMISSION OIL**

Front Differential	32 oz / 0.946 L	9779158
75W-90 Gear Oil, Synthetic		
Gearbox	32 oz / 0.946 L	9779160
75W-140 Gear Oil, Synthetic		

### **EMISSION CONTROL**

Fuel Tank Vent Breather Filter	Non-EVAP models	709001120
Canister Vent Pre-filter	CARB and EVAP models	709000524
Canister Fuel Filter	CARB and EVAP models	513034047

### **AIR FILTER** 715900422

### **CVT AIR FILTER** 706600423

## **DRIVE BELT**

HD11	Premium (Stock)	422280652
------	-----------------	-----------

### **CLUTCH MAINTENANCE KITS**

pDrive Ramp Rollers	Maintenance Kit	420629237
pDrive Torque Rollers	Maintenance Kit	420629224
QRS XD Roller Kit	Pack of 3	861805583

### **BRAKE PAD KITS**

Front Brake Pads (4 pads + hardware)	Defender (all models)	703501260
Rear Brake Pads (4 pads + hardware)	Defender MAX (all)	703501260
	Defender non-MAX (all)	703501261

### **CV BOOT KITS**

Front Wheel Side	715901034
Front Differential Side	715901035
Rear Wheel Side	715901064
Rear Differential Side	715901063

### **WHEEL BEARINGS** 293350151

### **BALL JOINTS**

Lower	703501262
Upper	703501263

### **SPARK PLUG**

HD11	715900785
------	-----------

### **BATTERY**

30 aH Yuasa Y1X30L fact. activated	515176151
------------------------------------	-----------

\*\*Refer to periodic maintenance chart for proper intervals.

# CAN-AM MAVERICK R



To make sure your Maverick R performs as you expect, **keep an eye on these components.\*\***

## **OIL FILTER** 420956747

### **ENGINE OIL**

4T 10W-50 Synthetic Oil	1 quart / 946 ml	9779234
	1 US gallon / 3.785 L	9779235
4T 0W-40 Synthetic Oil	1 quart / 946 ml	9779139
	1 US gallon / 3.785 L	9779140
4T 5W-40 Full Synthetic Oil	1 quart / 946 ml	9779492
	1 US gallon / 3.785 L	9779493

### **OIL CHANGE KIT**

5W-40 Oil Change Kit	Rotax 999T	9779500
10W-50 Oil Change Kit	Rotax 999T	9779501

### **TRANSMISSION OIL**

Oil Change Kit	Can-Am DCT Transmission	9779725
Differential Oil	32 oz / 0.946 L	9779158
75W-90 Gear Oil, Synthetic		
DCT Gearbox Oil	DCT Fluid 32 oz / 0.946 L	9779710
XPS Synthetic		

### **EMISSION CONTROL**

Fuel Tank Vent Breather Filter	Non EVAP models	709001120
Canister Vent Pre-filter	CARB and EVAP models	709000524
Canister Fuel Filter	CARB and EVAP models	513034047

### **AIR FILTER**

Performance Air Filter by Twin Air <sup>†</sup>		715002895
Premium Air Filter		715900422

### **BRAKE PAD KITS**

Front Brake Pads	4 pads + hardware	703501223
Rear Brake Pads	4 pads + hardware	703501226

## **CV BOOT KITS**

Rear wheel side, NT1 transmission	Base, X and X rs	715500543
Rear diff side, NT1 transmission	Base, X and X rs	715500542
Rear (wheel side), NT2 transmission	MAX & X rc models	715900929
Rear (diff. side), NT2 transmission	MAX & X rc models	715500551
Front (wheel & diff. side)		715900450

## **WHEEL HUBS (with integrated bearings)**

Front		705402652
Rear		705503036

## **BALL JOINTS**

Lower		703501263
Upper		703501262

## **SPARK PLUG**

		715900935
--	--	-----------

## **BATTERY**

18 aH Yuasa YTX20L fact. activated	X & X rs	410301203
30 aH Yuasa YIX30L fact. activated	X rc	515176151

\*\*Refer to periodic maintenance chart for proper intervals.

# CAN-AM MAVERICK X3



To make sure your Maverick X3 performs as you expect,  
**keep an eye on these components.\*\***

## **OIL FILTER** 420956123

### **ENGINE OIL**

4T 10W-50 Synthetic Oil	1 quart / 946 ml	9779234
	1 US gallon / 3.785 L	9779235
4T 0W-40 Synthetic Oil	1 quart / 946 ml	9779139
	1 US gallon / 3.785 L	9779140
4T 5W-40 Full Synthetic Oil	1 quart / 946 ml	9779492
	1 US gallon / 3.785 L	9779493

### **OIL CHANGE KIT**

5W-40 Full Synthetic	900 ACE	9779489
10W-50 Synthetic Oil	900 ACE	9779261

### **TRANSMISSION OIL**

Front Differential	32 oz / 0.946 L	9779158
75W-90 Gear Oil, Synthetic		
Gearbox	32 oz / 0.946 L	9779160
75W-140 Gear Oil, Synthetic		

### **EMISSION CONTROL**

Fuel Tank Vent Breather Filter	Non EVAP models	709001120
Canister Vent Pre-filter	CARB and EVAP models	709000524
Canister Fuel Filter	CARB and EVAP models	513034047

### **AIR FILTER**

Performance Air Filter by Twin Air†	715002895
Premium Air Filter	715900422

### **CVT AIR FILTER** 706600416

## **DRIVE BELT** 422280652

### **CLUTCH MAINTENANCE KITS**

pDrive Ramp Rollers	Maintenance Kit	420629237
pDrive Torque Rollers	Maintenance Kit	420629224
QRS XD Roller Kit	Pack of 3	861805583

### **BRAKE PAD KITS**

Front Brake Pads	4 pads + hardware	703501198
Rear Brake Pads	4 pads + hardware	703501199

### **CV BOOT KITS**

Rear Wheel & Differential Side	715900450
Front Wheel & Differential Side	705401354

### **WHEEL BEARINGS** 293350151

### **BALL JOINTS**

Lower	703501262
Upper	703501263

### **SPARK PLUG**

Maverick X3	Except 900HO	415130363
Maverick X3	900HO	415130795

### **BATTERY**

18 aH Yuasa YTX20L fact. activated	410301203
------------------------------------	-----------

\*\*Refer to periodic maintenance chart for proper intervals.

# CAN-AM MAVERICK SPORT, MAVERICK TRAIL AND COMMANDER



To make sure your Maverick Sport, Trail or Commander performs as you expect, **keep an eye on these components.\*\***

## OIL FILTER 420256188

### ENGINE OIL

4T 10W-50 Synthetic Oil	1 quart / 946 ml	9779234
	1 US gallon / 3.785 L	9779235
4T 0W-40 Synthetic Oil	1 quart / 946 ml	9779139
	1 US gallon / 3.785 L	9779140
4T 5W-40 Full Synthetic Oil	1 quart / 946 ml	9779492
	1 US gallon / 3.785 L	9779493

### OIL CHANGE KIT

#### 500 cc or more V-twin engine

0W-40 Synthetic Oil		9779259
5W-40 Full Synthetic		9779488
10W-50 Synthetic Oil		9779252

#### ACE 650 cc Single Cylinder

0W-40 Full Synthetic		9779481
5W-40 Full Synthetic		9779480

### TRANSMISSION OIL

Front Differential	32 oz / 0.946 L	9779158
75W-90 Gear Oil, Synthetic		
Gearbox	32 oz / 0.946 L	9779160
75W-140 Gear Oil, Synthetic		

### EMISSION CONTROL

Fuel Tank Vent Breather Filter	Non EVAP models	709001120
Canister Vent Pre-filter	CARB and EVAP models	709000524
Canister Fuel Filter	CARB and EVAP models	513034047

### AIR FILTER

Performance Air Filter by Twin Air†		715002895
Maverick Trail & Sport	700 cc & 1000 cc	715900394
Maverick Trail & Sport	1000R	715900422
Commander	700 cc & 1000 cc	715900394
Commander	1000R	715900422

<b>CVT AIR FILTER</b>	Except X mr	706600417
-----------------------	-------------	-----------

### DRIVE BELT

Maverick Trail	700	422280225
Maverick Trail / Sport	1000	422280656
Commander	700	422280225
Commander	2021+ 1000 cc	422280656
Performance (upgrade)	See Reference Chart for upgrade	

### CLUTCH MAINTENANCE KITS

#### Commander 700, Maverick Trail 700

pDrive Ramp Rollers	Maintenance Kit	420629237
pDrive Torque Rollers	Maintenance Kit	420629224

#### Commander 1000R, Maverick Sport 1000R

QRS XD Roller Kit	Pack of 3	861805583
-------------------	-----------	-----------

### BRAKE PAD KITS

Front Brake Pads	4 pads + hardware	703501198
Rear Brake Pads	4 pads + hardware	703501199

### CV BOOT KITS

#### Maverick Sport, Commander (ABS, X xc, X mr, X rc models only)

Front Wheel Side		705401354
------------------	--	-----------

#### Maverick Sport (no ABS, Base and DPS models only), Maverick Trail (all models)

Front Wheel Side		705401345
Front Differential Side		705401355
Rear		705501864

### WHEEL BEARINGS

		293350150
--	--	-----------

### A-ARM BUSHING KIT

		703500875
--	--	-----------

### BALL JOINTS

Lower		703501262
-------	--	-----------

Upper		703501263
-------	--	-----------

<b>SPARK PLUG</b>		715900637
-------------------	--	-----------

Maverick Trail	700	715900785
----------------	-----	-----------

Maverick Trail & Sport	1000	715901051
------------------------	------	-----------

Maverick Trail & Sport	1000R	715900244
------------------------	-------	-----------

Commander	700	715900785
-----------	-----	-----------

Commander	1000R	715900244
-----------	-------	-----------

<b>BATTERY</b>		
----------------	--	--

18 aH Yuasa YTX20L fact. activated		410301203
------------------------------------	--	-----------

\*\*Refer to periodic maintenance chart for proper intervals.

Can-Am air filters are built for harsh conditions, delivering superior filtration without choking performance. Made to meet exact specs and protect engines from dust, mud, and debris, they're the first line of defense when the ride gets rough.

## BUILT STRONG. FILTERS SMARTER.

Each filter features high-density pleated media for maximum dirt-holding capacity, a molded seal for tight fit, and durable construction to prevent collapse in extreme conditions. Engineered to work in sync with Can-Am engines—no guesswork, no compromise.



### AIR FILTERS

#### Premium Air Filter



#### Models

Defender & Traxter G1, all packages incl. MAX, 2016–2026 Maverick Sport & Trail except 1000R engine, 2018–2026 Commander 700, incl. MAX, 2022–2026	715900394	\$52.99
Maverick X3, all packages incl. MAX, 2017–2026 Maverick R (incl. MAX), 2024–2026 Maverick Sport & Trail (incl. MAX), 1000R engine only, 2019–2026 Commander (incl. MAX), 1000R engine only, 2021–2026 Defender & Traxter G2, all packages, 2026	715900422	\$52.99
Maverick G1 except 1000T engine, 2013–2018 Commander G1 2011–2020	707800327	\$52.99
Maverick G1, 1000T engine only, 2015–2017	715900356	\$48.49

### OIL FILTERS

#### Engine Oil Filter



#### Models

Defender G1, Commander, Maverick Trail, Maverick Sport	420256188	\$13.77
Maverick X3, Defender G2 HD11	420956123	\$13.77
Maverick R	420956747	\$20.99

#### Transmission Oil Filter

(Not illustrated)

#### Model

Maverick R	420956127	\$20.99
------------	-----------	---------

## SPARK PLUGS

Spark Plugs	Models		
	Commander 2013–2017	715901051	\$6.35
	Commander 700 2022 and up	715900785	\$21.99
	Commander 800R 2018–2020	715901051	\$6.35
	Commander 1000R 2018 and up	715900244	\$14.83
	Defender HD5 2017–2021	715900352	\$21.99
	Defender HD7 2022 and up	715900785	\$21.99
	Defender HD8 2016–2021	715901051	\$6.35
	Defender HD9 2022 and up	715901051	\$6.35
	Defender HD10 2020 and up	715900244	\$14.83
	Defender HD11 2026	715900785	\$21.99
	Maverick 1000 2014	715900244	\$14.83
	Maverick 2015–2017	715900357	\$21.99
	Maverick 1000R 2015–2018	715900244	\$14.83
	Maverick Trail 700 2022 and up	715900785	\$21.99
	Maverick Trail 800R/1000 2021 and up	715901051	\$6.35
	Maverick Sport 1000 2019–2022	715901051	\$6.35
	Maverick Sport 1000R 2019 and up	715900244	\$14.83
	Maverick X3 900HO 2018	415130795	\$10.59
	Maverick X3 2017 and up (except 900HO)	415130363	\$21.99
	Maverick R 2024 and up	715900935	\$21.99

## BATTERIES

Yuasa Batteries	Models	Type	Amp-hours		
	Commander	Yuasa YTX20L fact. activated	18	410301203	\$154.99
	Defender (base/DPS models)	Yuasa YTX20L fact. activated	18	410301203	\$154.99
	Defender (except Base/DPS models)	Yuasa YIX30L fact. activated	30	515176151	\$219.99
	Maverick	Yuasa YTX20L fact. activated	18	410301203	\$154.99
	Maverick Sport/Trail	Yuasa YTX20L fact. activated	18	410301203	\$154.99
	Maverick X3	Yuasa YTX20L fact. activated	18	410301203	\$154.99
	Maverick R (X & X rs)	Yuasa YTX20L fact. activated	18	410301203	\$154.99
	Maverick R (X rc)	Yuasa YIX30L fact. activated	30	515176151	\$219.99

**CAN-AM AXLES ARE ENGINEERED TO EXACT TOLERANCES, TESTED TO ENDURE EXTREME LOADS, AND BUILT WITH HIGH-GRADE MATERIALS TO HANDLE HEAT, FLEX, AND ABUSE WITHOUT COMPROMISE.**

Genuine Can-Am axles perfectly match drivetrain, steering, and suspension geometries to reduce steering effort, premature wear, and unwanted loads on components such as ball joints, tie-rods, and bearings.

Can-Am axles do more than just transmit power. They protect your ride with carefully engineered thresholds, absorbing stress to protect the rest of your drivetrain.

Every Can-Am axle is precision-machined, heat-treated chromium and molybdenum alloy steel, combined with TPE CV boots and friction- and heat-reducing grease, resulting in longer joint life.



## **HOLD THE POWER. TAKE THE HIT.**

Axles act as pressure points in the power system, absorbing stress to help protect more complex and costly components. No weak links. Just smart engineering.



# AXLES

	Model / Package / Engine*	Years	Front				Rear			
			Right Axle	Left Axle	Boot (diff. side)	Boot (wheel side)	Right Axle	Left Axle	Boot (diff. side)	Boot (wheel side)
<b>Maverick X3</b>										
<b>Width 72"</b> (incl. MAX models)	XRS & XRS DPS (Visco-Lok)	2017	705402100	705402099	705401354	705401354	705502362	715900450	715900450	
	XRS Turbo R (Visco-Lok)	2018	705402100	705402099	705401354	705401354	705502362	715900450	715900450	
	XRS Turbo R (Smart-Lok) XMR Turbo R (Smart-Lok) XRC Turbo R (Smart-Lok)	2018–2019	705402048		705401354	705401354	705502362	715900450	715900450	
	RS Turbo R (Visco-Lok)	2020–2021	705402100	705402099	705401354	705401354	705502362	715900450	715900450	
	XRS Turbo & Turbo RR XRC Turbo & Turbo RR XMR Turbo RR	2020–2026	705402048		705401354	705401354	705502362	715900450	715900450	
	RS Turbo RR	2022–2026	705402048		705401354	705401354	705502362	715900450	715900450	
	RS Turbo	2024–2026	705402048		705401354	705401354	705502362	715900450	715900450	
<b>Width 64"</b> (incl. MAX models)	Base, XDS, XDS DPS (Visco-Lok)	2017	705402098	705402097	705401354	705401354	705502154	715900450	715900450	
	XDS Turbo R (Visco-Lok)	2018	705402098	705402097	705401354	705401354	705502154	715900450	715900450	
	Base (Visco-Lok) Turbo (Visco-Lok) Turbo R (Visco-Lok)	2018–2020	705402098	705402097	705401354	705401354	705502154	715900450	715900450	
	DS Turbo (Visco-Lok) DS Turbo R (Visco-Lok)	2021	705402098	705402097	705401354	705401354	705502154	715900450	715900450	
	XRC Turbo (Smart-Lok) XMR Turbo (Smart-Lok)	2018–2021	705401634		705401354	705401354	705502154	715900450	715900450	
	XDS Turbo R (Smart-Lok)	2019	705401634		705401354	705401354	705502154	715900450	715900450	
	XDS Turbo (Smart-Lok) XDS Turbo RR (Smart-Lok)	2020–2021	705401634		705401354	705401354	705502154	715900450	715900450	
	DS Turbo & Turbo RR XMR Turbo RR XRC Turbo RR XDS Turbo RR	2022–2026	705401634		705401354	705401354	705502154	715900450	715900450	

## Maverick R

All models	2024	705402490	715900450	715900450	705503778	715500542	715500543
Base X XRS	2025–2026	705402490	715900450	715900450	705503778	715500542	715500543
Base MAX X MAX XRS MAX XRC & XRC MAX	2025–2026	705402490	715900450	715900450	705503943	715500551	715900929

## Defender G1

<b>Base / DPS</b> (incl. MAX models)	Base HD5 DPS HD5	2017–2021	705401936	705401937	705401355	705401345	705502479	705502478	705501864	705501864	
	Base HD7 DPS HD7	2022–2026	705402750	705402749	705401355	705401345	705503100		705501864	705501864	
	Base HD8 DPS HD8	2016–2021	705401936	705401937	705401355	705401345	705502451		705501864	705501864	
	Base HD9 DPS HD9	2022–2026	705401936	705401937	705401355	705401345	705502451		705501864	705501864	
	Base HD10 DPS HD10	2016–2019	705401936	705401937	705401355	705401345	705502451		705501864	705501864	
	DPS HD10	2020–2026	705402407	705402408	705401355	705401345	705502831		705501864	705501864	
	CAB HD8	2019	705402170	705402171	705401355	705401345	705503051		705501864	705501864	
	CAB HD10	2018–2019	705402170	705402171	705401355	705401345	705503051		705501864	705501864	
	DPS CAB HD8	2021	705402449	705402450	705401355	705401345	705503051		705501864	705501864	
	DPS CAB HD9	2022	705402449	705402450	705401355	705401345	705503051		705501864	705501864	
	DPS CAB HD9	2023–2026	705403204	705403205	705401355	705401354	705503051		705501864	705501864	
	<b>XT / XTP / XU</b> (incl. MAX models)	XT HD8 XU HD8	2016–2021	705401936	705401937	705401355	705401345	705502451		705501864	705501864
		XT CAB HD8 XT CAB HD10	2016–2017	705401936	705401937	705401355	705401345	705502451		705501864	705501864
		XT CAB HD8	2018	705402170	705402171	705401355	705401345	705503051		705501864	705501864
XTP HD10		2018	705401936	705401937	705401355	705401345	705502451		705501864	705501864	
		2019	705402353		705401355	705401345	705502451		705501864	705501864	
		2020	705402407	705402408	705401355	705401345	705502831		705501864	705501864	
XT CAB HD10 XT CAB HD8		2020	705402449	705402450	705401355	705401345	705503051		705501864	705501864	
XU HD7		2022–2026	705402750	705402749	705401355	705401345	705503100		705501864	705501864	
XT HD9 XU HD9		2022–2026	705401936	705401937	705401355	705401345	705502451		705501864	705501864	
XU HD10		2023–2025	705402407	705402408	705401355	705401345	705502831		705501864	705501864	
XT HD10	2020–2026	705402407	705402408	705401355	705401345	705502831		705501864	705501864		

\*Includes MAX models unless otherwise specified.

## AXLES

	Model / Package / Engine*	Years	Front				Rear			
			Right Axle	Left Axle	Boot (diff. side)	Boot (wheel side)	Right Axle	Left Axle	Boot (diff. side)	Boot (wheel side)
<b>Defender G1 (continued)</b>										
<b>Limited / Lone Star (incl. MAX models)</b>	Lone Star HD10	2018–2019	705402170	705402171	705401355	705401345	705503051	705501864	705501864	
	Limited CAB HD10 Lone Star HD10	2020	705402449	705402450	705401355	705401345	705503051	705501864	705501864	
	Mossy Oak Edition HD10	2020	705402575		705401355	705401354	705503051	705501864	705501864	
	Limited CAB HD10 Lone Star HD10 Lone Star CAB HD10	2021–2022	705402449	705402450	705401355	705401345	705503051	705501864	705501864	
	Limited CAB HD10 Lone Star HD10 Lone Star CAB HD10	2023	705403204	705403205	705401355	705401354	705503051	705501864	705501864	
	Lone Star HD10 Lone Star CAB HD10 Limited HD10	2024–2025	705402420		705401355	705401354	705503051	705501864	705501864	
	<b>XMR (incl. MAX models)</b>	XMR HD10	2018	705402228		705401355	705401354	705503051	705501864	705501864
XMR HD10		2019–2025	705402420		705401355	705401354	705503051	705501864	705501864	
<b>Defender PRO G1</b>										
<b>Pro</b>	Pro HD8 Pro HD10	2018–2019	705401936	705401937	705401355	705401345	705502451	705501864	705501864	
	Pro DPS HD10 Pro XT HD10	2020–2026	705402407	705402408	705401355	705401345	705502831	705501864	705501864	
	Pro LoneStar HD10 Pro Limited CAB HD10	2021–2022	705402449	705402450	705401355	705401345	705503051	705501864	705501864	
	Pro Limited CAB HD10	2023	705403204	705403205	705401355	705401354	705503051	705501864	705501864	
	Pro Limited CAB HD10	2024–2026	705402420		705401355	705401354	705503051	705501864	705501864	
<b>Defender 6x6 G1</b>										
<b>6x6</b>							2nd (middle) axle	3rd (rear) axle		
	6x6 DPS HD10	2020–2022	705402407	705402408	705401355	705401345	705502831	705502850	705501864	
	6x6 XT HD10	2021–2022	705402407	705402408	705401355	705401345	705502831	705502850	705501864	
	6x6 Limited CAB HD10	2022	705402449	705402450	705401355	705401345	705503051	705503271	705501864	
	6x6 DPS HD10 6x6 XT HD10	2023–2026	705402407	705402408	705401355	705401345	705502831	705502831	705501864	
	6x6 Limited HD10	2023	705403204	705403205	705401355	705401354	705503051	705501864	705501864	
	6x6 Limited HD10	2024–2026	705402420		705401355	705401354	705503051	705501864	705501864	
<b>Defender G2</b>										
<b>Incl. MAX models</b>	LoneStar & LoneStar CAB Limited CAB XMR	2026	705403358		715901035	715901034	705503483	715901063	715901064	
	XT & XT CAB XU	2026	705403360	705403361	715901035	715901034	705503483	715901063	715901064	
<b>Commander G1</b>										
<b>Incl. MAX models</b>	All models	2011–2015	705401872	705401871	705401346	705401345	705502359	705501864	705501864	
	All models	2016–2020	705401872	705401871	705401346	705401345	705502411	705501864	705501864	
<b>Commander G2</b>										
<b>Incl. MAX models</b>	DPS 1000R	2021–2026	705402030	705402031	705401355	705401345	705502552	705501864	705501864	
	XT 700 & HD7 DPS 700 & HD7	2022–2026	705402873	705402874	705401355	705401345	705502552	705501864	705501864	
	XT 1000R	2021–2026	705402717	705402718	705401355	705401345	705502757	705501864	705501864	
	XTP 1000R	2021–2026	705402282		705401355	705401354	705502757	705501864	705501864	
	XMR 1000R	2022–2026	705402282		705401355	705401354	705502757	705501864	705501864	
<b>Maverick Trail</b>										
<b>Width 50'</b>	Trail DPS 1000R	2018–2019	705402007	705402008	705401355	705401345	705502541	705501864	705501864	
	Trail Base & DPS 800	2018–2021	705402007	705402008	705401355	705401345	705502541	705501864	705501864	
	Trail Base & DPS 1000	2018–2026	705402007	705402008	705401355	705401345	705502541	705501864	705501864	
	Trail Base & DPS HD7/700	2022–2026	705402879	705402880	705401355	705401345	705502541	705501864	705501864	
<b>Maverick Sport</b>										
<b>Incl. MAX models</b>	Base 1000 DPS 1000	2019–2022	705402030	705402031	705401355	705401345	705502552	705501864	705501864	
	DPS 1000R	2019–2026	705402030	705402031	705401355	705401345	705502552	705501864	705501864	
	XMR 1000R XRC 1000R	2019–2026	705402282		705401355	705401354	705502757	705501864	705501864	
	XXC 1000R	2020–2023	705402282		705401355	705401354	705502757	705501864	705501864	

\*Includes MAX models unless otherwise specified.

## BALL JOINT

### Suspension Arm Ball Joint with Hardware



#### Models

Lower	Upper		
All models & packages except Maverick R, 2015-2026	Maverick R, 2024-2026	703501262	\$36.99
Maverick R, all packages, 2024-2026	Defender & Traxter, G1 & G2, all packages 2017-2026 Maverick X3, All Packages, 2018-2026 Maverick Sport & Trail, all packages 2018-2026 Commander G2, all packages 2021-2026	703501263	\$36.99
—	Commander G1, 2011-2020 Maverick G1, 2014-2018	703501264	\$36.99

Strength, stability, and control. Can-Am A-arms and ball joints are built to keep the suspension locked in and tires planted. Engineered for max articulation, impact resistance, and durability in brutal terrain, they help keep machines running and riders moving.

## MADE TO FLEX. BUILT TO HOLD.

High-strength ball joints absorb punishing hits and deliver full-angle movement without binding. Superior sealing and lubrication keep dirt out and performance in. Designed to maintain contact with the ground, because traction means control, and control means confidence.



These are the same high-performance pads installed at the factory, now available in complete kits for quick, full replacements. Engineered with Can-Am, in collaboration with Brembo, to deliver consistent stopping power, even in the toughest off-road conditions.

## BUILT FOR BRUTAL STOPS

These pads are optimized for off-road abuse, built to handle heat, grit, and repeat impact. Every kit includes the right components for a full pad swap, with stopping power that never backs down.

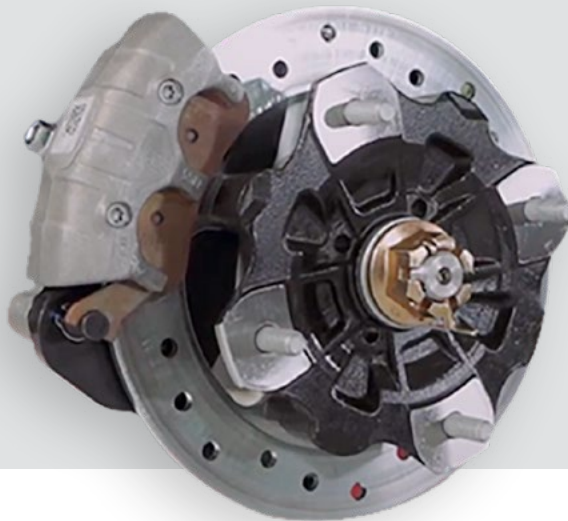

### BRAKE PADS

#### Brake Pad Kits

Include left and right pads, spring and pin

	Models	Front		Rear	
	Maverick R	703501223	\$211.99	703501226	\$190.99
	Defender HD7	703501198	\$116.49	703501200	\$116.49
	Defender HD9				
	Defender HD10				
	Defender PRO				
	Defender 6X6				
	Defender HD7 MAX				
	Defender HD9 MAX				
	Defender HD10 MAX			703501199	\$116.49
	Maverick X3				
	Maverick Sport				
	Maverick Trail				
	Commander				



Engineered to fit each Can-Am model, BRP drive belts are precisely calibrated to match clutch systems for maximum transfer, zero RPM loss, and unmatched throttle response. Field-tested and race-proven, they're built to take the heat. Literally.

# DESIGNED TO PERFORM. PROVEN TO WIN.

From dyno to desert, BRP drive belts are tested in brutal real-world and race conditions.

1

## THE TOP COG

adds strength and limits deformation. It's made from a different compound than the lower cog to suit distinct power transfer roles.

2

## ADHESION LAYERS

promote bonding between the cogged undercord compound and the aramid cord.

3

## THE TENSILE CORD

is made with lightweight, high-strength aramid cords, each layer matched to your vehicle's specific power and performance demands.

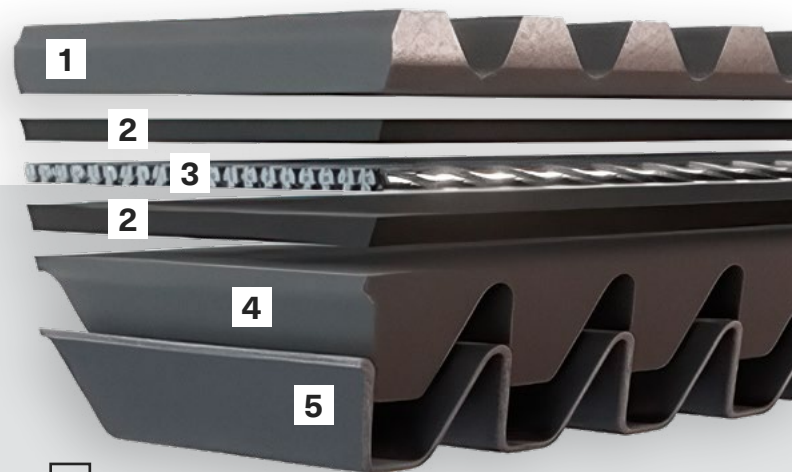

4

## THE UNDERCORD

is a custom mix of natural/synthetic rubbers and high-performance materials, designed for ideal flex and clutch engagement.

5

## IMPREGNATED FABRIC

boosts wear resistance for both the belt and your clutches.

## BELTS

Drive Belts	Models	CVT Drive Belt		Belt Upgrade		CVT Cover Gasket	
	Commander 700 2022 and up	422280225	\$154.99	—	—	—	—
	Commander 2020 and prior	422280366	\$179.99	—	—	420430126	\$41.49
	Commander 2021 and up (1000cc)	422280656	\$174.99	422280652	\$239.99	420450400	\$31.99
	Defender HD5 2017-2021	422280283	\$104.99	—	—	—	—
	Defender HD7 2022 and up	422280225	\$154.99	—	—	—	—
	Defender HD8 2016-2021	422280656	\$174.99	422280652	\$239.99	—	—
	Defender HD9 2022 and up	422280656	\$174.99	422280652	\$239.99	420450400	\$31.99
	Defender HD10 2018-2019	422280656	\$174.99	422280652	\$239.99	—	—
	Defender HD10 2020 and up	422280652	\$239.99	—	—	420450400	\$31.99
	Defender HD11 2026	422280652	\$239.99	—	—	—	—
	Maverick Trail 700 2022 and up	422280225	\$154.99	—	—	—	—
	Maverick Sport/Trail 1000 2018 and up	422280656	\$174.99	422280652	\$239.99	420450400	\$31.99
	Maverick X3 2018 and up (except 900HO)	422280652	\$239.99	—	—	420450405	\$31.99
	Maverick X3 900HO 2018	422280656	\$174.99	422280652	\$239.99	—	—

## PDRIVE MAINTENANCE KITS

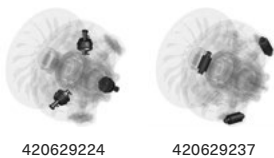
pDrive Maintenance Kits	Models	Torque Rollers Maintenance Kit	Ramp Rollers Maintenance Kit	
	Commander 700 2022 and up	420629224	420629237	N/A
	Defender HD7 2022 and up			N/A
	Maverick Trail 700 2022 and up			N/A
	Maverick X3 Turbo 2023 and up			N/A
	Maverick X3 Turbo RR 2022 and up			N/A

## QRS ROLLERS

QRS XD Roller Kit (pack of 3)	Models		
	Commander 1000R 2021 and up	861805583	\$124.99
	Defender HD9 2022 and up		
	Defender HD10 2020 and up		
	Defender HD11 2026		
	Maverick Sport 1000R 2019 and up		
	Maverick X3 Turbo/Turbo R 2018 and up		
	Maverick X3 Turbo RR 2020 and up		
	Maverick X3 900HO 2018		
Maverick X3 2017-2018			

QRS XD Roller Kit (pack of 2)	Models		
	Defender HD8 2016-2021	861805577	\$82.99
	Defender HD10 2016-2019		
	Maverick 1000 Turbo XDS 2015-2017		
	Maverick Sport 1000 2019-2022		
	Maverick Trail 800/800R 2018-2021		
	Maverick Trail 1000 2018 and up		

DUPLICATE OF LOAD APPLIED

### DEFORMATION RESISTANCE UNDER STATIC COMPRESSION TEST

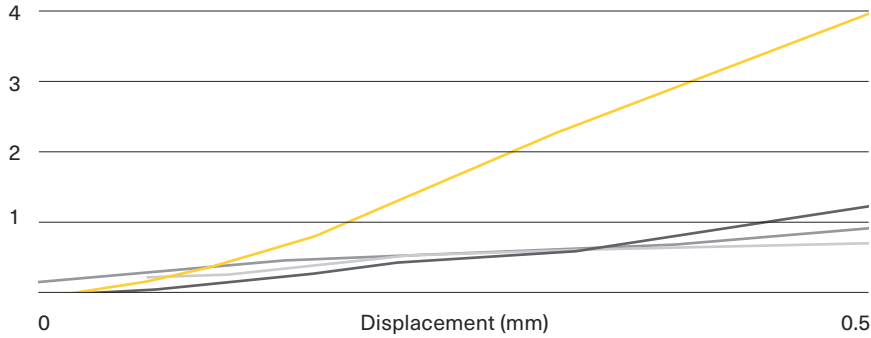

#### BRP XD roller

The **BRP XD roller** withstands 4 times the load in compression compared to most popular aftermarket thermoplastic-type rollers with a displacement/deformation of 0.5 mm.

QRS XD rollers are built to take a beating. With more impact resistance and less deformation than standard designs, they hold up under pressure, protect belt performance, and keep the pulley system running clean and smooth, ride after ride.

## BUILT TOUGH TO KEEP POWER MOVING

Stronger than fiber rollers and more stable than thermoplastic designs, QRS XD rollers resist high-impact shocks and deformation that can seize pulleys or shred belts. A major upgrade for reliability, durability, and consistent performance under stress.



NUMBER OF CYCLES

### CYCLING TEST

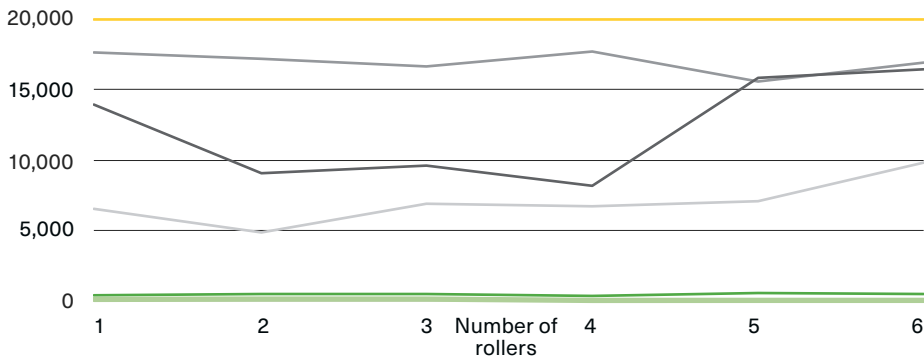

#### BRP XD Roller

#### Thermoplastic Type Sample 3

#### Thermoplastic Type Sample 2

#### Thermoplastic Type Sample 1

#### Fiber Type Sample 2

#### Fiber Type Sample 1

The **BRP XD rollers** performed 40% more cycles\* than the average for thermoplastic-type rollers and 99% more cycles\* than the average for fiber-type rollers. Both thermoplastic and fiber roller tests ended in failure.  
\*Based on 20,000 cycles of our XD rollers, without any signs of failure.



# XPS

## A TIRE FOR EVERY PURPOSE.



## XPS TIRES

aren't just made to fit your vehicle, they're made to work perfectly with it.

### DESIGN

Designed and engineered specifically for Can-Am, all tread patterns and tire aspects have been crafted to exact XPS specifications, giving you an exclusive tire designed to perform like no other.

### TESTING

Every XPS tire goes through extreme testing—such as puncture, mileage, speed rating, and weight—to meet the same performance standards as your Can-Am vehicle.

### COMPLETE LINEUP

The fast-growing lineup of XPS tires covers a vast range of the most popular sizes and specifications. ATV or SSV, 6- or 8-ply rating, radial or not, XPS has a purpose built tire for your playground.

# XPS TIRES

## SHOP BY USAGE

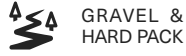

### NEW XPS Hammer King



- 8-ply rated construction.
- Flatter tire profile for large contact patch.
- Tread pattern is tighter to help float over desert type terrain and keep ride smoother at high speeds.
- Aggressive sidewall for increased traction when in rocky terrain.
- Tread depth: 15 mm (0.6").

<b>705403785</b> · UT 32X10R15	<b>\$291.49</b>
<b>705403945</b> · UT 30X10R14	N/A
<b>705403683</b> · UT 35X10R16	<b>\$352.99</b>
<b>705403784</b> · UT 30X10R15	<b>\$275.49</b>

### XPS Hammer Force



- Light truck-inspired tire.
- 8-ply rated construction.
- Rock-crawling tread pattern with unique contact patch.
- Aggressive sidewall for maximum traction when faced with technical terrains.
- Tread depth: 15 mm (0.6").

<b>705402918</b> · 30X10R15	<b>\$296.99</b>
-----------------------------	-----------------

### XPS Trail King 2



- All-terrain radial tire.
- 8-ply rated construction.
- Tire excels in various terrains, from loose to hard packed.
- Non-directional tread pattern with optimized construction providing precision handling and ensuring maximum grip and low rolling resistance
- Tread depth: 20 mm (0.8").

<b>705403482</b> · 29X9R14	<b>\$291.49</b>
<b>705403663</b> · 29X11R14	<b>\$312.49</b>

### XPS Trail King



- All-terrain radial tire.
- 8-ply rated construction.
- Aggressive tread pattern for tougher terrains.
- An almost continuous center tread offers a smoother trail ride.
- Tread depth: 26 mm (1.02").

<b>705403081</b> · 27X9R14	<b>\$169.49</b>
<b>705503355</b> · 27X11R14	<b>\$174.99</b>
<b>705402825</b> · 28X9R14	<b>\$179.99</b>
<b>705503181</b> · 28X11R14	<b>\$185.49</b>

### XPS Trail Force



- All-terrain radial tire.
- 8-ply rated construction.
- Versatile and suitable for many types of terrain.
- Aggressive tread pattern for better traction on dirt, mud and rocky terrains.
- Tread depth: 20 mm (0.78").

<b>705402754</b> · 27X9R14	<b>\$142.99</b>
<b>705503103</b> · 27X11R14	<b>\$153.49</b>

### XPS Trac Force



- All-terrain light truck style radial tire.
- 8-ply rated construction.
- Central tread for good grip and comfort on compact terrain.
- Tread depth: 18 mm (0.71").

<b>705403080</b> · 30X9R14	<b>\$275.49</b>	<b>705403370</b> · 30X10R15	<b>\$275.49</b>
<b>705403369</b> · 30X9R15	<b>\$275.49</b>	<b>705403416</b> · UT 32X10R16*	<b>\$296.99</b>
<b>705503354</b> · 30X10R14	<b>\$285.99</b>	<b>705403587</b> · UT 32X10R15*	<b>\$291.49</b>
<b>705403586</b> · UT 30X10R14*	<b>\$285.99</b>	*6 ply rating	

### XPS Swamp King



- Radial tires for mud and trail.
- 8-ply rated construction.
- Ultimate performance in mud without sacrificing good trail handling.
- Tread depth: 38 mm (1.5").

<b>705503855</b> · UT 30X10R15	<b>\$296.99</b>
--------------------------------	-----------------

### XPS Swamp Force



- Hybrid radial tire for mud and trail.
- 8-ply rated construction.
- Unique tread pattern allowing good grip in mud and mud ejection.
- Center tread provides for comfortable trail riding.
- Tread depth: 36-38 mm (1.41"-1.5").

<b>705403201</b> · 30X9R14	<b>\$275.49</b>
<b>705503387</b> · 30X11R14	<b>\$296.99</b>



Powersport engines are some of the most powerful for their size. This reality creates a lot of pressure and stress on all components, including oils and lubricants. Finding the right balance between lubrication and durability is hard, but that's exactly what you'll find in every XPS bottle. Our chemistry evolved over thousands of testing hours to deliver power and durability like only XPS can.

# XPS

## OIL THAT GOES THE DISTANCE



## XPS OILS

Developed as an integral part of the engine and vehicle, XPS lubricants don't settle for a certification. Always looking for more power and torque is in our DNA. This quest for performance created our need for specifically engineered lubricants.

# LUBRICANT & OIL CHANGE KIT

## LUBRICANT

### XPS 4T 10W-50 Synthetic Oil



- Engineered for heavy-duty and high-performance 4-stroke engines, including turbocharged, supercharged and racing engines.
- Formulated using carefully selected and strenuously tested base stocks and custom additives.
- Offers thick film strength to protect bearings and a proven high-temp detergency to minimize deposits, prevent shear, provide thermal stability, and combat fuel dilution to ensure maximum performance from your engine.

**9779234** · 1 qt / 946 ml  
**9779235** · 1 US gal / 3.785 L

### XPS 4T 0W-40 Synthetic Oil

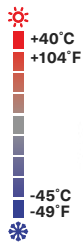

- Powersport formula with premium anti-wear and anti-corrosion additives.
- The best choice for high-performance snowmobile, ATV and SXS 4-stroke engines used in cold weather.
- Provides superior engine and transmission protection against heat, rust and corrosion.
- Delivers optimal performance in high and low temperatures.

**9779139** · 1 qt / 946 ml  
**9779140** · 1 US gal / 3.785 L

### XPS 4T 5W-40 Synthetic Oil



- Off-road formula with premium anti-wear and anti-corrosion additives.
- Designed for high-performance off-road, on-road and PWC 4-stroke engines, including turbo or supercharged powersports engines.
- Provides superior engine and transmission protection against rust and corrosion, even in extreme conditions.

**9779492** · 1 qt / 946 ml  
**9779493** · 1 US gal / 3.785 L

## OIL CHANGE KIT

### Engine Oil Change Kit



- Ultra-convenient "all-in-one" Engine Oil Change Kit saves time and money.
- Includes XPS Synthetic or Synthetic Blend Oil, oil filter, O-rings and washer.

Engine	Product	
<b>Mono Cyl</b>		
450 cc or less	Can-Am Oil Change Kit 5W40	<b>9779487</b>
ACE 650 cc Single Cylinder	Can-Am Oil Change Kit 5W40	<b>9779480</b>
ACE 650 cc Single Cylinder	Can-Am Oil Change Kit 0W40	<b>9779481</b>
<b>VTwin</b>		
500 cc + V-Twin	Can-Am Oil Change Kit 5W40	<b>9779488</b>
500 cc + V-Twin	Can-Am Oil Change Kit 0W40	<b>9779259</b>
500 cc + V-Twin	Can-Am Oil Change Kit 10W50	<b>9779252</b>
<b>3 Cyl</b>		
Rotax 999T	Can-Am Oil Change Kit 5W40	<b>9779500</b>
Rotax 999T	Can-Am Oil Change Kit 10W50	<b>9779501</b>
Rotax 900/999 ACE	Can-Am Oil Change Kit 5W40	<b>9779502</b>
Rotax 900/999 ACE	Can-Am Oil Change Kit 10W50	<b>9779503</b>
Rotax 900/999 ACE	Can-Am Oil Change Kit 0W40	<b>9779504</b>

# MAINTENANCE PRODUCTS

## Synthetic Gear Oil

75W-90

**9779158** • 1 qt / 946 ml

75W-140

**9779160** • 1 qt / 946 ml



- Uses custom additives to provide the best performance in Visco-Lok™ and Smart-Lok™ differentials.
- Allows higher loads, superior shear stability and reduced oxidation.
- Exceptional wear protection and superior performance at all operating temperatures.

## XPS Synthetic DCT Fluid

**9779710** • 1 qt / 946 ml



- Meets or exceeds API GL-4 industry specifications.
- Formulated for dual clutch system.
- Enhanced cooling capabilities for optimal clutch functionality.
- Anti foaming agents for smooth hydraulic function.

## Extended Life Pre-Mixed Coolant

**9779150** • 1 qt / 946 ml



- Antifreeze/coolant contains the correct dilution and the necessary additives to prevent corrosion and inhibit cavitation in BRP cooling systems.
- Long-life, 5-year formula specially formulated for BRP vehicles.
- Superior heat transfer.
- Ideal replacement for vehicles that normally use a 2-year antifreeze/coolant (green).
- 5 years (orange).

## DOT 4 Brake Fluid

**9779151** • 12 fl oz / 355 ml



- Meets or exceeds all DOT3 and DOT4 brake fluid requirements.
- High-temperature formula resists fade and also conditions seals and O-rings in braking system.

## Racing Brake Fluid RS600

**9779152** • 12 fl oz / 355 ml



- Exceeds DOT4 brake fluid requirements for extreme conditions and competition use.
- Extreme, 579-degree boiling point temperature is ideal for high-demand competition conditions to combat brake fade.
- Will not harm seals or braking system components.
- Should be added only to a clean/unfilled system to avoid dilution and diminished performance.
- Low-moisture formula slows water vapor absorption through multiple heat cycles.
- Recommended for use in Ski-Doo and Can-Am racing applications.

## Fuel Stabilizer

**9779171** • 8 fl oz / 236 ml



- Ethanol-compatible and will stabilize fuel in your tank to keep it from breaking down and causing hard starting, throttle hesitation and poor run quality.
- Since ethanol attracts moisture, this product contains powerful anti-corrosion additives to protect fuel system components.
- Prevents problems associated with E10 fuels.

---

**Anti-Corrosive Lubricant****9779701** • 14 oz / 400 g

- Multipurpose lubricant that can also be used to prevent rust, corrosion and moisture intrusion.
- It contains extreme pressure additives that work as an all-around lubricant for just about anywhere lubrication is needed.

---

**Extreme Duty Suspension Grease****9779708** • 14 oz / 400 g

- Designed to work specifically with the components found in Can-Am vehicle suspensions.
- It is highly stable and offers optimal lubrication at both extreme cold and high temperatures while protecting suspension components from dirt and moisture, as well as corrosion under extreme washout conditions.

---

**XPS Spline Grease****9779704** • 3 fl oz / 118 ml

- Formulated with molybdenum disulfide and synthetic graphite for maximum durability and long-lasting protection.
- High performance formula that protects against wear, seizure, rust, corrosion, and extreme temperatures.
- Ensures smooth assembly and disassembly, with consistent low-friction performance.



# XPS

**KEEP IT CLEAN.  
KEEP IT RUNNING.**



## XPS CARE

We know riding can get dirty real quick! To make sure riders spend more time riding and less time scrubbing, XPS Care offers a full lineup of products that make cleaning and detailing simple and efficient. Our proprietary solutions dissolve the dirt and grime, protect finishes, and even restore colors.

Level up your washing routine with XPS Care.

# CARE PRODUCTS

## Cleaner and Degreaser, All Purpose



- Ready-to-use formula.
- Cleans toughest dirt and grime.
- Phosphate free eco-friendly formula.
- Low-foam easy rinse formula.

**9779328** • 22 fl oz / 650 ml

**9779329** • 2 qt / 1.89 L

## Matte Finish Waterless Cleaner



- Easy waterless use.
- Perfect for matte, flat and denim surfaces.
- Contains no wax or silicone.
- Leaves no unwanted streaks or marks.

**9779330** • 22 fl oz / 650 ml

## Multi-Surface and Glass Cleaner



- Easy waterless spray and wipe use.
- Polymer formula cleans and protects.
- Contains no wax or silicone.
- Leaves no unwanted streaks or marks.

**9779331** • 22 fl oz / 650 ml

## Mud and Dust Off-Road Wash



- Specially formulated for off-road vehicles, it breaks the bond holding grime and dirt to your vehicle's finish.
- The formula is biodegradable and eco-friendly with no phosphates or corrosive chemicals and is low foam for easy, quick rinsing.
- Effective on oil, grease and other stubborn grime.
- Safe for use on all surfaces.

**9779340** • 33 fl oz / 946 ml

**9779341** • 2 qt / 1.89 L

## Black Plastic and Rubber Restorer



- Restores plastic, rubber and vinyl.
- Long-lasting formula.
- Protects against UV rays.

**9779335** • 7.6 fl oz / 225 ml

## Foaming Wash



- Concentrated formula for off-road vehicles, it produces a thick foam to lift dirt and prevent scratching.
- The pH neutral formula is safe for wax and paint sealants.
- Works in pressure washers or by hand.

**9779337** • 16 fl oz / 473 ml

**9779338** • 2 qt / 1.89 L

## Quick Detailer Gloss Enhancing



- Quick detail spray wax.
- Leaves a high gloss finish at every wipe.
- Nanotechnology polymer formula.
- Repels dirt.
- No water needed.

**9779332** • 4 fl oz / 118 ml

**9779333** • 16 fl oz / 473 ml



# CAN-AM APPAREL



# CAN-AM APPAREL

Sizing chart	241
Communication systems	243
Helmets and goggles	245
Mud gear	249
Rainwear	249
Gloves	250
Can-Am x Fasthouse	252
Everyday wear	259
Signature collection	263
UV Protection and Play	268
Play and licensing products	269
Replacement parts	270

---

Always use the digital version  
of the Products Spec Book for  
the most updated information.

---





# What code represents your style?

- 1 Find your size and color.
- 2 The corresponding code is THE CODE you use to complete the part number on your order.

Example:  
440975 (style number for the Men's Sythe Mesh Jacket CE/UKCA)  
06 (sizing code M)  
90 (color code Black)

**Full SKU:**      **Style**      **Size**      **Color**  
440975      06      90

## SIZING CODE

Adult		Adult		Adult		Adult		Adult		Adult		Youth / Kids	
Size	Code	Size	Code	Size	Code	Size	Code	Size	Code	Size	Code	Size	Code
One Size	00	XLT	13	X	26	5	24	13	33	36	40	3-4	79
XS	02	2XL	14	1X	86	6	25	14	34	38	41	5-6	52
S	04	2XLT	15	2X	87	7	27	16	35	40	42	6-8	48
M	06	3XL	16	3X	95	8	28	18	78	42	43	7-8	54
MT	07	3XLT	17	1	20	9	29	28	36			10-12	49
L	09	4XL	18	2	21	10	30	30	37	S / M	72	14-16	50
LT	10	4XLT	19	3	22	11	31	32	38	M / L	91		
XL	12	5XL	88	4	23	12	32	34	39	L / XL	73		

## COLOR CODE

Name	Code	Name	Code	Name	Code	Name	Code
Clear	00	Warm Grey	15	Ice	38	Light Blue	81
White	01	Lava Red	17	Violet	41	Indigo Blue	82
Brown	04	Mixed Color	18	Deep Purple	42	Royal Blue	83
Charcoal Grey	07	Mirror Silver	22	Smoke	57	Navy	89
Silver	08	Magnesium	24	Green	70	Black	90
Grey	09	Lilac	25	Teal	74	Black with Graphics	94
Yellow	10	Hi-Vis Yellow	26	Turquoise (Aqua)	76	Amber	95
Gold	11	Heather Charcoal	29	Army Green	77	Ivory	97
Orange	12	Red	30	Denim Blue	79		
Coral	13	Pink	36	Blue	80		

## APPAREL AND SPORTSWEAR

### MEN'S - 5'7"-6'0"

	XS	S	M	L	XL	2XL	3XL	4XL
<b>Sizing Code</b>	02	04	06	09	12	14	16	18
<b>Chest</b>	31-33	34-36	38-40	42-44	46-48	50-52	54-56	58-60
<b>Waist</b>	27½-28½	29½-30½	32½-34½	36½-39	41½-43½	46-48	50½-52½	54-57
<b>Hips (seat)</b>	31½-32½	33½-35½	37½-39½	41½-43¼	45-46¾	48½-50½	52½-54½	56½-58½
<b>Arm length</b>	30½	32½	33	33½	34½	35	36	36½
<b>Inseam</b>	30½	32	32	32	32	32	32	32

### WOMEN'S - 5'3"-5'8"

	XS	S	M	L	XL
<b>Sizing Code</b>	02	04	06	09	12
<b>Chest</b>	33½-35½	35½-36½	37½-39	41-43	45-47
<b>Waist</b>	27-28	29-30	31-32½	34½-36½	39-41½
<b>Hips (seat)</b>	36½-37½	38½-39½	40½-42	43-45½	47-49½
<b>Arm length</b>	30½	30½	31	31½	32½
<b>Inseam</b>	30	30	30	30	30

Glove sizing information is available on page 250.

## HELMETS

### MEN'S & WOMEN'S

	2XS	XS	S	M	L	XL	2XL	3XL
<b>Sizing Code</b>	01	02	04	06	09	12	14	16
<b>Head (inches)</b>	20¾-21¼	21¾-22	22¾-22¾	23¾-23¾	24-24¾	24¾-25¾	24¾-25¾	25½-25¾
<b>Head (cm)</b>	53-54	55-56	57-58	59-60	61-62	63-64	63-64	65-66

# VIBE ON ANY HELMET

The Vibe Communication System delivers unparalleled connectivity and versatility when you ride. Fully compatible with most BRP helmets, this comm system might as well be an extension of the vehicle's ecosystem. This standout lets you chat, listen and ride all day long in comfort no matter how cold it is!



## DID YOU KNOW ABOUT VIBE AND THE BRP GO! APP?

Ready, set, go! Set up and manage the Vibe Communication System in no time directly in the free BRP GO! mobile app. You can check the battery level, modify the audio settings and much more!

ONE CLICK TO CONNECT WITH OTHER MESH RIDERS	UNPARALLELED TALK TIME UP TO 12 HOURS (8 HOURS AT 0 °F)
SOUND BY HARMAN/KARDON®	OPEN MESH INTERCOM
UNIVERSAL FIT AND EASY TOOLLESS ASSEMBLY	FULL COMPATIBILITY WITH MOST HELMETS



OPEN MESH INTERCOM: LIMITLESS



MULTI-LANGUAGE VOICE COMMAND



GROUP MESH INTERCOM: UP TO 24 RIDERS



INTERCOM UP TO 2 KM / 1.2 MILES IN OPEN TERRAIN

## COMMUNICATION SYSTEMS

### Vibe Universal Comm System by BRP

929105 • One size

Matte Black (93)

MISC



- VIBE UNIVERSAL Comm System with superior audio quality for most BRP helmets.
- Sound by Harman Kardon®.
- Mesh-only system: Robust reliability compatible with all Sena Mesh devices.
- Battery capacity: up to 12 hours of talk time (8 hours at 0 °F).
- One-click-to-connect simplicity with other mesh riders.
- Mesh Intercom™ features superior audio quality.
- Up to 2 km/1.2 miles in open terrain. Range can be extended with multiple riders.
- Multi-channel protocol in open mesh allows users to switch between nine comm channels.
- Convenience of voice-activated digital assistant access ("OK Google"/"Hey Siri").
- Rapid charging.
- Glove-friendly interface.
- Compatible with all BRP helmets.
- When paired with the BRP GO! app, you can manage many settings such as sound, mesh channel options, software updates, battery level, handlebar control and more.
- Wired and boom microphones included.
- 3-year limited warranty.

*For safety reasons, the battery cannot be charged while riding. Considering the increased risks inherent in charging a battery, BRP has chosen NOT to make this action possible to guarantee maximum user safety.*

# PYRA AND FLINT: BETTER THAN EVER!

The Can-Am Pyra helmets: where style meets performance. With the lightest helmet in our collection featuring high airflow and ERT protection, you'll be covered!

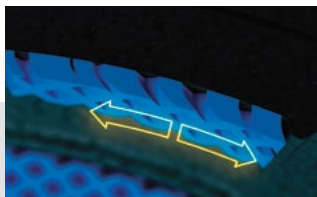

## PROTECTION

Energy Reduction Technology (ERT) redirects force away from the head in the event of a fall.



## LIGHTWEIGHT

Our lightest helmet starting at 1,240 g.



## AIRFLOW

Don't sweat the ride with an open chin, removable wind deflector and rear vents.

- LIGHTWEIGHT 
- ACCESSIBLE 
- DOT/ECE 

## PERFECT FIT!

Experience unmatched comfort and fit with the Flint goggles and Pyra helmet—the ideal combination for your ride.



Can-Am Pyra Phantom Helmet  
BLACK  
929159\_90



Can-Am Pyra Phantom Helmet  
GREY  
929159\_09



Can-Am Flint Phantom UV Goggles  
RED  
286834\_30



Can-Am Flint Phantom UV Goggles  
SMOKE  
286834\_57

The Can-Am Flint goggles feature an injected PC lens that is anti-scratch and anti-fog and has distortion-free optics.

- ✓ UV protection
- ✓ Anti-fog
- ✓ Anti-scratch
- ✓ Frameless
- ✓ Designed to fit with the Pyra helmet

Second lens included



# HELMETS AND GOGGLES

UNISEX

## Can-Am Pyra Phantom Helmet

DOT ECE22.06

929159 • XS, S, M, L, XL, 2XL, 3XL

Black (90), Grey (09)



- 4-year limited warranty.
- Advanced plastic-composite shell with Energy Reduction Technology (ERT).
- Two-position adjustable peak.
- Front and rear hi-max air vent system to maximize cooling.
- Removable, washable and replaceable moisture-wicking liner.
- Lightweight double-D chin strap.
- Weight: ±1,270 grams for size Large.
- DOT/ECE 2206 certified.

## Can-Am Pyra Fade Helmet

DOT ECE22.06

929078 • XS, S, M, L, XL, 2XL, 3XL

Beige (02), Turquoise (Aqua) (76), White (01)



- 4-year limited warranty.
- Advanced plastic-composite shell with Energy Reduction Technology (ERT).
- Two-position adjustable peak.
- Front and rear hi-max air vent system to maximize cooling.
- Removable, washable and replaceable moisture-wicking liner.
- Lightweight double-D chin strap.
- Weight: ±1,310 grams for size Large.
- DOT/ECE 2206 certified.

## Can-Am Pyra Helmet

DOT ECE22.06

929038 • XS, S, M, L, XL, 2XL, 3XL

Charcoal Grey (07)



- 4-year limited warranty.
- Advanced plastic-composite shell with Energy Reduction Technology (ERT).
- Two-position adjustable peak.
- Front and rear hi-max air vent system to maximize cooling.
- Removable, washable and replaceable moisture-wicking liner.
- Lightweight double-D chin strap.
- Weight: ±1,310 grams for size Large.
- DOT/ECE 2206 certified.

## Can-Am Flint Phantom UV Goggles

286834 • One size

Red (30), Smoke (57)



- The Can-Am Flint Phantom goggles feature an injected PC lens that is anti-scratch and anti-fog and has distortion-free optics.
- Thermo-formed 3-layer face foam offers best fit.
- No-slip silicone strap keeps goggles in place.
- Injection-molded PC cylindrical lens provides distortion-free vision and enhanced impact resistance.
- Tinted lens with anti-scratch and anti-fog performance with mirrored coating.
- Included extra clear lens for low-light conditions.
- Removable nose guard for extra deflection against debris.

**Can-Am Flint Photochromic Goggles**

448779 - One size

Charcoal Grey (07)



- Thermo-formed 3-layer face foam offers best fit.
- No-slip silicone strap keeps goggles in place.
- Injection-molded PC cylindrical lens provides distortion-free vision and enhanced impact resistance.

- Lens VLT from 80% to 28% with anti-scratch and anti-fog performance and with mirrored coating.
- Removable nose guard for extra deflection against debris.

**Can-Am Trench UV Goggles**

448696 - One size

Charcoal Grey (07), White (01)



- The Can-Am Trench goggle features injection PC lens that is anti-scratch and anti-fog and has distortion-free optics.
- Thermo-formed 3-layer face foam offers best fitting.
  - No-slip silicone strap keeps goggles in place.

- Injection-molded PC cylindrical lens provides distortion-free vision and enhanced impact resistance.
- Single lens with anti-scratch and anti-fog performance.
- Removable nose guard for extra deflection against debris.

**Can-Am Trench OTG Goggles**

448792 - One size

Matte Black (93)



- The Can-Am Trench OTG goggles feature an injected PC lens that is anti-scratch and anti-fog and has distortion-free optics.
- Thermo-formed 3-layer face foam offers best fit.
  - No-slip silicone strap keeps goggles in place.
  - Injection-molded PC cylindrical lens provides distortion-free vision and enhanced impact resistance.

- Single lens with anti-scratch and anti-fog performance.
- Removable nose guard for extra deflection against debris.
- Fits over most of the prescription glasses on the market with lens height below 2 in. (51 mm) and with arm width of 5 3/4 in. (146 mm).



# FULL-FACE ACCESSIBILITY

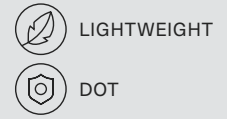

## Open-Face Helmets

Designed for freedom and visibility. Offering a wide field of vision, allowing you to better enjoy the scenery and stay aware of your surroundings. You'll be sure to be comfortable with these stylish and ultra-light helmets.



**BLACK WITH GRAPHICS**  
929150\_94

**MATTE BLACK**  
929140\_93

### LIGHTWEIGHT

Advanced light-plastic composite shell. Enjoyable for short or longer rides.

### OPEN-FACE HELMET

Perfect for full-face accessibility.

### COMFORT

Ultra-comfortable and washable linings.

UNISEX	<b>NEW Can-Am Retro Open Face Helmet</b>	DOT	929150 • S, M, L, XL, 2XL	Black with Graphics (94), Matte Black (93)
			<ul style="list-style-type: none"> <li>Advanced thermoplastic shell.</li> <li>Multi-density EPS.</li> <li>2 shell sizes and 3 EPS sizes for better fit and comfort.</li> <li>Removable peak.</li> <li>Ultra-comfort, removeable and hand-washable linings.</li> </ul>	<ul style="list-style-type: none"> <li>Quick-release chin strap.</li> <li>Eyewear compatible.</li> <li>Communication system-ready.</li> <li>Fit: Medium Oval.</li> <li>DOT-certified.</li> </ul> <p>Weight</p> <ul style="list-style-type: none"> <li>- XS-L: 1,140 g ± 50 g.</li> <li>- XL-XXL: 1,200 g ± 50 g.</li> </ul>
	<b>Can-Am Exome Helmet</b>	DOT ECE2206	929040 • XS, S, M, L, XL, 2XL, 3XL	Sand (03), Charcoal Grey (07)
		<ul style="list-style-type: none"> <li>Perfect for adventure riding, on or off the trails.</li> <li>Modular helmet with advanced plastic-composite shell.</li> <li>Pinlock-ready multi-position and anti-scratch visor.</li> <li>Interchangeable retractable sun visor.</li> <li>Removable aerodynamic peak.</li> <li>Ultra-comfortable washable linings.</li> <li>Adjustable air vents and exhausts.</li> <li>DOT/ECE 2206 certified.</li> </ul>		
<b>Can-Am Exome Open-Face Helmet</b>	DOT	929140 • XS, S, M, L, XL, 2XL, 3XL	Grey (09), Matte Black (93)	
		<ul style="list-style-type: none"> <li>Perfect for adventure riding, on or off the trails in summer conditions.</li> <li>Advanced plastic composite shell.</li> <li>Anti-scratch amber visor.</li> <li>Interchangeable retractable sun visor.</li> <li>Fixed aerodynamic peak.</li> <li>Ultra-comfortable washable linings.</li> <li>Adjustable air vents and exhausts.</li> <li>DOT-certified.</li> </ul>		

## HELMETS

### MEN'S & WOMEN'S

	2XS	XS	S	M	L	XL	2XL	3XL
<b>Sizing Code</b>	01	02	04	06	09	12	14	16
<b>Head (inches)</b>	20 7/8-21 1/4	21 1/8-22	22 3/8-22 3/4	23 1/8-23 3/8	24-24 3/8	24 3/4-25 1/8	24 3/4-25 1/8	25 1/2-25 7/8
<b>Head (cm)</b>	53-54	55-56	57-58	59-60	61-62	63-64	63-64	65-66

# PHANTOM

## Introducing the beloved Phantom collection

Built for riders who demand more. Featuring a 100% waterproof jacket and pants, but also protective gear such as helmet and goggles. All of them showcasing the striking phantom graphic. Full protection. Maximum style.



Can-Am Pyra  
Phantom Helmet  
**BLACK**  
929159\_90



Can-Am Flint  
Phantom UV  
Goggles  
**SMOKE**  
286834\_57



Unisex Can-Am  
Waterproof  
Mud Jacket  
**CAMO**  
456046\_37



Unisex Can-Am  
Waterproof  
Mud Pants  
**BLACK**  
456067\_90

Unisex Can-Am  
Waterproof  
Mud Jacket  
**BLACK**  
456046\_90

# MUD GEAR

UNISEX

## Can-Am Waterproof Mud Jacket

456046 • S, M, L, XL, 2XL

Black (90), Camo (37)



- Mud jacket made of waterproof PVC.
- 98.5% polyvinyl chloride (PVC), 1.5% mesh polyester.
  - Electronically welded seams.
  - Back panel ventilation (with mesh).
  - Elastic cuffs, hem and hood.
  - Can-Am logo.

## Can-Am Waterproof Mud Pants

456067 • S, M, L, XL, 2XL

Black (90), Camo (37)



- Oversized pants made of 100% waterproof PVC.
- 100% polyvinyl chloride (PVC).
  - Electronically welded seams.
  - Elastic waistband and ankle cuff.
  - Can-Am logo.

# RAINWEAR

UNISEX

## NEW Unisex Can-Am Seil Lite WP Jacket

456072 • S, M, L, XL, 2XL, 3XL

Hi-Vis Yellow (26)



- Simple yet carefully designed and beautifully made lightweight weather protection unisex jacket. 100% waterproof. Intelligent sizing – To be fit over your normal riding gear, sized accordingly.
- Main material: 100% laminated polyester.
  - Fit: Relax.
  - Waterproof/breathable: 10K/3K, 2.5-layer membrane.
  - Hi-vis material at sleeves.
  - Fully seam-sealed.
  - Double storm placket front closure with one-way zipper.
  - Stowable adjustable hood (inside collar).
  - Reflective details and logo.
  - Elasticized cuff with silicone grip inside.
  - Back panel ventilation.
  - Adjustable hem.
  - Lightweight.
  - Unisex sizing to fit over clothes.
  - One size down for women.

## NEW Unisex Can-Am Seil Lite WP Overpants

442457 • XS, S, M, L, XL, 2XL, 3XL

Black (90)



- Simple yet carefully designed and beautifully made lightweight weather protection unisex overpants. 100% waterproof. Intelligent sizing – To be fit over your normal riding gear, sized accordingly.
- Main material: 100% laminated polyester.
  - Fit: Relax.
  - Waterproof: 10K/3K, 2.5-layer membrane.
  - Elastic waistband with silicone grip all around.
  - Silicone grip at bottom hem.
  - Fully seam-sealed.
  - Reflective logo.
  - Hem opening with zipper.
  - Stretch boot straps.
  - Lightweight.
  - Unisex sizing to fit over clothes.
  - One size down for women.

# GLOVES

MEN'S

## NEW Can-Am Rally Gloves

286836 · S, M, L, XL, 2XL, 3XL

Black (90)



Our new Can-Am Rally Gloves are highly breathable for hot riding conditions.

Mesh on the upper and light perforated microsuede on the inside of the palm for a perfect grip and air flow.

- 92% polyester, 8% spandex.

- Ventilated air mesh upper construction.

- Reinforcement thumb panel for extra durability.

- Single-layer microsuede palm with minimal padding.

- Stretch finger gussets.

- Embossed and expandable neoprene slip-on cuff.

- Touchscreen function.

## GLOVES (measure palm width)

### UNISEX

	XS	S	M	L	XL	2XL	3XL
Sizing Code	02	04	06	09	12	14	16
Palm (inches)	3	3¼	3½	4	4½	5	5½
Palm (cm)	7.5	8	9.5	10	11.5	13	14



# CAN-AM x FASTHOUSE

Desert racing runs deep in Fasthouse's roots. Their passion is forged by the camaraderie, good times and heritage of Fasthouse is built upon the legacy of those who came before it, while forging its own path by being the Purveyors of Good Times®. This collection merges Fasthouse's aesthetic with Can-Am Off-Road's prowess, a partnership that sets a new benchmark for off-road lifestyle, capturing the core of their shared values and leaving behind a legacy for all to revel in.



Men's Can-Am x FH  
Ride Out T-Shirt  
BLACK  
288225\_90



Men's Can-Am x FH  
Adventure Long  
Sleeve T-Shirt  
WHITE  
288226\_01  
BLACK  
288226\_90

Unisex  
Can-Am x FH  
Dust Gloves  
BLACK  
446389\_90



Men's Can-Am x FH  
Mav T-Shirt  
SAND  
288218\_03  
BLACK  
288218\_90



Women's Can-Am x FH  
Adventure T-Shirt  
BLACK  
288228\_90



# CAN-AM x FASTHOUSE

MEN'S

## NEW Unisex CAN-AM x FH Dust Gloves

446389 • XS, S, M, L, XL, 2XL Black (90)



The Dust gloves utilize quality materials with a traditional moto fit.

- 77% polyamide, 15% polyurethane, 7% elastane, 1% polychloroprene.
- Durable form-fitting 2-way stretch material.
- Perforated Clarino® palm and thumb guards.

- Touchscreen fingertips on index and thumb.
- Gusseted knuckles for increased dexterity.
- Molded neoprene low-pro cuff.
- Mesh finger gussets and silicone grippers.
- TPR and printed embellishments throughout.

## NEW Can-Am x FH Dust Pants

288018 • 28, 30, 32, 34, 36, 38, 40, 42 Black (90)



The Dust pants are designed for those who venture off the beaten path. They feature a classic fit with cargo-style pockets, full-grain leather inner knee panels, and 600D poly main panel construction, all engineered to endure the harshest conditions and enhance your performance for the adventure ahead.

- 69% polyester, 27% nylon, 4% spandex.
- Fit: Fitted
- Zippered cargo pockets.

- Zippered mesh ventilation pockets on both thighs.
- Zippered fly for easy pit stops.
- 600-denier poly and 4-way stretch main body fabric.
- High-strength nylon thread, double- and triple-stitched seams.
- Silky soft tricot, ¾-length knee brace, optimized lining.
- Patterned and fit for every style of rider.

Please refer to the sizing chart below:

Size	Code	Size	Code	Size	Code	Size	Code
28	36	32	38	36	40	40	42
30	37	34	39	38	41	42	43

## NEW Can-Am x FH Mav Pullover Hoodie

288227 • S, M, L, XL, 2XL, 3XL Gold (11)



Midweight hooded pullover for men.

- 80% cotton, 20% polyester.
- Soft midweight material (280 gsm).
- Fit: Regular.
- Two front welt pockets.
- Metal eyelets and hood drawstring.
- Screen printed graphics.
- Ribbed sleeve cuffs and waistband hem.

## NEW Can-Am x FH Triad T-Shirt

288236 • S, M, L, XL, 2XL, 3XL Black (90), Heather Charcoal (29)



Can-Am x Fasthouse Collab T-Shirt with brand logos and graphics

- 60% cotton, 40% polyester.
- Fit: Slim.
- Ribbed collar.

## Can-Am x FH Motorall

441716 • 28, 30, 32, 34, 36, 38, 40, 42 Black (90)



The Motorall® is our tried and true Grindhouse moto pant in an overalls cut.

- 69% polyester, 27% nylon, 4% spandex.
- Fit: Fitted.
- Zippered cargo pockets on front chest and both thighs.
- Zippered mesh ventilation pockets on both thighs.
- Zippered fly for easy pit stops.
- Adjustable elastic comfort straps for step-in entry.

- 600-denier poly and 4-way stretch main body fabric.
- Upper chest molle straps for radios, tools and accessories.
- High-strength nylon thread double- and triple-stitched seams.
- Silky soft tricot, ¾-length knee brace, optimized lining.
- Patterned and fit for every style of rider.

Please refer to the sizing chart below:

Size	Code	Size	Code	Size	Code	Size	Code
28	36	32	38	36	40	40	42
30	37	34	39	38	41	42	43

<b>NEW Can-Am x FH Dust Jersey</b>	<b>288234</b> • S, M, L, XL, 2XL, 3XL	Army Green (77), Black (90)
------------------------------------	---------------------------------------	-----------------------------



- High-performance jersey utilizing breathable materials with a traditional cut.
- 100% polyester.
  - Fit: Regular.
  - High-quality silk-screened graphics.
  - Moisture-wicking materials help keep you dry.
  - Mesh vent paneling on sides and under sleeves for airflow.
  - Drop tail on back panel to keep jersey tucked in and secure.
  - Athletic fit, moderately slim throughout body and sleeves.
  - Overlocked stitching for superior durability and longevity.

<b>NEW Can-Am x FH High Country T-Shirt</b>	<b>288235</b> • S, M, L, XL, 2XL, 3XL	Bronze (92)
---	---------------------------------------	-------------



- Can-Am x Fasthouse Collab T-Shirt with large soft plastisol print at back and small print at front chest.
- 60% cotton, 40% polyester.
  - Fit: Slim.
  - Rib-knit crew neck.
  - Woven label Can-Am x Fasthouse on wearer's right sleeve.

<b>Can-Am x FH Mav T-Shirt</b>	<b>288218</b> • S, M, L, XL, 2XL, 3XL	Black (90), Sand (03)
--------------------------------	---------------------------------------	-----------------------



- Can-Am x Fasthouse collab T-shirt with large artistic vehicle print at back.
- 60% cotton, 40% polyester.
  - Fit: Slim.
  - Ribbed collar.
  - Quote at left chest and large artwork at back.

<b>Can-Am x FH Off-Road Crew T-Shirt</b>	<b>288224</b> • S, M, L, XL, 2XL, 3XL	Army Green (77), Black (90)
--	---------------------------------------	-----------------------------



- Can-Am x Fasthouse collab T-shirt with large Off-Road graphic at back.
- 60% cotton, 40% polyester.
  - Fit: Slim.
  - Ribbed collar.
  - Quote at left chest and back.

<b>Can-Am x FH Ride Out T-Shirt</b>	<b>288225</b> • S, M, L, XL, 2XL, 3XL	Black (90), White (01)
-------------------------------------	---------------------------------------	------------------------



- Can-Am x Fasthouse collab T-shirt with artistic landscape printed at back.
- 60% cotton, 40% polyester.
  - Fit: Slim.
  - Ribbed collar.
  - Brand logo at center front and large artwork at back.

<b>Can-Am x FH Adventure Long-Sleeve T-Shirt</b>	<b>288226</b> • S, M, L, XL, 2XL, 3XL	Black (90), White (01)
--	---------------------------------------	------------------------



- Can-Am x Fasthouse collab long-sleeve T-shirt with brand logos and emblematic Can-Am lines.
- 60% cotton, 40% polyester.
  - Fit: Slim.
  - Ribbed collar.
  - Brand logos at center front and back.

**Can-Am x FH Coilover Tee****288065** • S, M, L, XL, 2XL, 3XL | Black (90)

- Ultrasoft 100% combed ring-spun cotton tee.
- 100% combed ring-spun cotton.
  - Fit: Slim.
  - Soft and lightweight material.
  - Crew collar.
  - Plastisol ink screen-printed graphics.

**NEW Can-Am x FH Off-Road Crew Pullover Hoodie****288229** • S, M, L, XL, 2XL | Ivory (97)

- Midweight hooded pullover for women.
- 80% cotton, 20% polyester.
  - Fit: Regular.
  - Soft midweight material (280 gsm).
  - Two front welt pockets.
  - Metal eyelets and hood drawstring.
  - Screen printed graphics.
  - Ribbed sleeve cuffs and waistband hem.

**Can-Am x FH Adventure T-Shirt****288228** • XS, S, M, L, XL, 2XL | Black (90), Sand (03)

- Can-Am x Fasthouse collab women's T-shirt with brand logos and emblematic Can-Am lines.
- 60% cotton, 40% polyester.
  - Fit: Slim.
  - Ribbed collar.
  - Brand logos at center front and back.

**NEW Can-Am x FH Adventure Beanie****288231** • One size | Army Green (77), Black (90)

- Can-Am x Fasthouse collab heavy-knit cuff beanie.
- 100% acrylic.
  - Ultrasoft anti-itch material.
  - Can-Am x Fasthouse woven patch at front.
  - Small folded Can-Am x Fasthouse label at back.

**NEW Can-Am x FH Straw Hat****448814** • One size | Khaki (05)

- Wide-brim straw hat with adjustable chin strap.
- 100% straw.
  - Patch at front.
  - One size fits most.

**NEW Can-Am x FH Tube****288232** • One size | Black (90), Wine (32)

- Multipurpose, stretch and comfortable tubular headwear.
- 92% polyester, 8% spandex.
  - 12 different configurations: bandana, headband, balaclava and more.

**Can-Am x FH Dust Mesh Cap****288238** • One size

Black (90), Whiskey (28)



Check out the Can-Am x FH Dust cap, a medium-profile structured 5-panel snapback constructed using a premium cotton/poly blend. Features a front patch and custom trims throughout.

- 60% cotton, 40% polyester.
- 5-panel construction.
- Deep profile, structured.
- Woven front patch.
- Contrast snapback closure.

**Can-Am x FH Road Cap****288230** • One size

Black (90)



Can-Am x Fasthouse collab structured 5-panel trucker-style cap with snapback closure.

- 100% cotton.
- 5-panel construction.
- Curved brim.
- Woven patch at front.
- Branded taping and flag label.
- Snapback closure at back.

**Can-Am x FH Racing Flat Brim Cap****448804** • One size

Black (90), Brown (04)



Structured 5-panel snapback with flat brim using premium acrylic wool.

- 100% cotton.
- 5-panel construction.
- Flat brim and matching underbrim.
- Branded taping and flag label.
- Contrast snapback.
- Snapback closure at back.

**Can-Am x FH Badge Cap****448805** • One size

Army Green (77), Ivory (97)



Structured 5-panel trucker-style cap with snapback closure.

- 100% cotton.
- 5-panel construction.
- Curved brim.
- Woven patch at front.
- Branded taping and flag label.
- Snapback closure at back.

# CAN-AM OFF-ROAD x 24.7

**Hunt limited-edition hat capsule.  
Built for the hunt, backed by the ride.**

Where grit meets gear: Can-Am Off-Road and 24.7 Hunt unveil an exclusive hat collection designed for those who live the outdoors without compromise. As a top Can-Am Off-Road Ambassador since 2024, 24.7 Hunt has earned a reputation as one of the most respected names in the hunting and conservation community, bringing proven insight, a relentless pursuit of the passion, and a deep respect for the land and its animals into everything they do.

This collaboration isn't just about style—it's about being unstoppable. These hats are made for the early risers and late nighters who do it all in their own pursuits.



Unisex Can-Am  
x 24.7 Curved Cap  
288482\_90



Unisex Can-Am  
x 24.7 Red/Black  
Flat Cap  
288483\_30



Unisex Can-Am  
x 24.7 Green  
Rope Cap  
288484\_77



Unisex Can-Am  
x 24.7 Black  
Mesh Flat Cap  
288485\_90



# 24.7 x CAN-AM COLLECTION

UNISEX

## Can-Am x 24.7 Curved Cap

288482 • One size

Black (90)



- Can-Am x 24.7 Hunt Collaboration.
- Content: 100% cotton corduroy.
  - 5-panel construction.
  - Curved brim.
  - Embroidered woven patch at front.
  - Embroidered brands on both sides of the cap.
  - Branded an-Am taping inside.
  - Snapback closure at back.

## Can-Am x 24.7 Red/Black Flat cap

288483 • One size

Red (30)



- Can-Am x 24.7 Hunt Collaboration.
- Content: 100% cotton corduroy.
  - 5-panel construction.
  - Flat brim.
  - Half structured front.
  - Rope.
  - Embroidered woven patch at front.
  - Embroidered brands on both sides of the cap.
  - Branded Can-Am taping inside.
  - Snapback closure at back.

## Can-Am x 24.7 Green Rope Cap

288484 • One size

Army Green (77)



- Can-Am x 24.7 Hunt Collaboration.
- Content: 100% cotton.
  - 5-panel construction.
  - Flat brim.
  - Rope.
  - Embroidered Duck patch in Can-Am color at front.
  - Embroidered brands on both sides of the cap.
  - Branded an-Am taping inside.
  - Snapback closure at back.

## Can-Am x 24.7 Black Mesh Flat Cap

288485 • One size

Black (90)



- Can-Am x 24.7 Hunt Collaboration.
- Content: 100% cotton.
  - 5-panel construction.
  - Flat brim.
  - Structured front.
  - Mesh back.
  - Embroidered woven patch at front.
  - Embroidered brands on both sides of the cap.
  - Snapback closure at back.

# EVERYDAY WEAR AND SIGNATURE

**Our redesigned everyday and Signature collections.**

Perfect for those who crave adventure and want to get the job done. Featuring a fresh selection of stylish and practical pieces such as flannel shirts, caps, T-shirts and more!



Men's Can-Am  
DNA T-Shirt  
ARMY GREEN  
288173\_77



Unisex Can-Am  
Loyal Flat Mesh Cap  
BLACK  
288143\_90



Unisex Can-Am  
Laser Cut Curved Cap  
SAND  
288144\_03



Unisex Can-Am  
Reversible Camo  
Beanie  
GREY  
288160\_09







Men's Can-Am  
Emblem Pullover  
Hoodie  
BLACK  
288244\_90



Men's Can-Am  
Plaid Flannel Shirt  
SAND  
288165\_03

# EVERYDAY WEAR

MEN'S

<p><b>NEW</b> Can-Am All-Star T-Shirt</p>	<p>288181 • S, M, L, XL, 2XL, 3XL</p>	<p>Army Green (77), Black (90), Wine (32)</p>
<div style="display: flex; align-items: flex-start;">  <div style="width: 65%;"> <p>Casual T-shirt for everyday wear.</p> <ul style="list-style-type: none"> <li>• 60% cotton, 40% polyester.</li> <li>• Fit: Slim.</li> <li>• Rib-knit crew neck.</li> </ul> </div> </div>		
<p><b>NEW</b> Can-Am All Terrain T-Shirt</p>	<p>288184 • S, M, L, XL, 2XL, 3XL</p>	<p>Black (90), Heather Grey (27)</p>
<div style="display: flex; align-items: flex-start;">  <div style="width: 65%;"> <p>Men's Casual Graphic T-Shirt with Can-Am Crest artwork.</p> <ul style="list-style-type: none"> <li>• Solid: 60% cotton, 40% polyester.</li> <li>• Heather: 97% cotton, 3% polyester.</li> <li>• Fit: Regular.</li> <li>• Rib-knit crew neck.</li> <li>• Small artwork at left chest and artwork at back.</li> </ul> </div> </div>		
<p><b>NEW</b> Can-Am Heritage T-Shirt</p>	<p>288275 • S, M, L, XL, 2XL, 3XL</p>	<p>Black (90), Heather Grey (27)</p>
<div style="display: flex; align-items: flex-start;">  <div style="width: 65%;"> <p>Men's Casual Graphic T-Shirt with Heritage artwork at back.</p> <ul style="list-style-type: none"> <li>• Solid: 60% cotton, 40% polyester.</li> <li>• Heather: 97% cotton, 3% polyester.</li> <li>• Fit: Regular.</li> <li>• Ribbed collar.</li> <li>• Small Can-Am logo at left chest and artwork at back.</li> <li>• Small embroidered label at front.</li> </ul> </div> </div>		
<p><b>NEW</b> Can-Am '73 T-Shirt</p>	<p>288276 • S, M, L, XL, 2XL, 3XL</p>	<p>Black (90)</p>
<div style="display: flex; align-items: flex-start;">  <div style="width: 65%;"> <p>Men's Casual Graphic T-Shirt with large '73 Can-Am logo at front.</p> <ul style="list-style-type: none"> <li>• 60% cotton, 40% polyester.</li> <li>• Fit: Regular.</li> <li>• Ribbed collar.</li> <li>• Small embroidered label at front.</li> </ul> </div> </div>		
<p><b>NEW</b> Can-Am Legacy T-Shirt</p>	<p>288279 • S, M, L, XL, 2XL, 3XL</p>	<p>Heather Charcoal (29), White (01)</p>
<div style="display: flex; align-items: flex-start;">  <div style="width: 65%;"> <p>Men's Casual Graphic T-Shirt with retro Can-Am logo at front.</p> <ul style="list-style-type: none"> <li>• 60% cotton, 40% polyester.</li> <li>• Fit: Regular.</li> <li>• Ribbed collar.</li> <li>• Small embroidered label at front.</li> </ul> </div> </div>		

**Can-Am Plaid Flannel Shirt****288165** • S, M, L, XL, 2XL, 3XL

Sand (03)



Comfortable plaid flannel shirt, perfect for all your adventures!

- 100% cotton.
- Fit: Regular.
- Front opening with debossed Can-Am 4-hole buttons.

- Left chest pocket with small Can-Am embroidery.
- Contrast woven back yoke, chest pocket and elbow patches for more durability.

**Can-Am Bonded Plaid Overshirt****288163** • S, M, L, XL, 2XL, 3XL

Army Green (77)



Bonded micro-fleece plaid overshirt, perfect for colder days.

- 100% cotton, fleece, 100% polyester.
- Fit: Relaxed.
- Front opening with debossed Can-Am 4-hole buttons.
- Herringbone weave bonded to soft micro polar fleece.
- Back yoke and chest pocket fabric cut on bias for stretch.

- Two hand pockets and two chest pockets.
- Small Can-Am embroidered logo at front left pocket.
- Self hanger loop centered at back yoke.

**Cobra Desert Pullover Hoodie****288155** • S, M, L, XL, 2XL, 3XL

Black (90), Heather Grey (27)



Casual pullover hoodie with desert-inspired artwork at back.

- 60% cotton, 40% polyester.
- Fit: Regular.

- Rib at cuffs and hem.
- Kangaroo pocket.
- Soft plastisol print graphic at back. Regular Can-Am logo at left chest.

**Cobra Desert T-Shirt****288151** • S, M, L, XL, 2XL, 3XL

Black (90), Sand (03)



Men's casual graphic T-shirt with desert-inspired artwork at back.

- 60% cotton, 40% polyester.
- Fit: Regular.

- Ribbed collar.
- Small Can-Am logo at left chest and artwork at back.

**Can-Am Loyal T-Shirt****288152** • S, M, L, XL, 2XL, 3XL

Black (90), Heather Grey (27)



Men's casual graphic T-shirt with Can-Am printed quote at back.

- 60% cotton, 40% polyester.
- Heather Grey (27): 97% cotton, 3% polyester.
- Fit: Regular.

- Ribbed collar.
- Small Can-Am logo at left chest and artwork at back.

**Can-Am Fearless Ally T-Shirt**

288153 • S, M, L, XL, 2XL, 3XL

Army Green (77), Black (90)



Men's casual graphic T-shirt with large cobra artwork at front.  
 • 60% cotton, 40% polyester.  
 • Fit: Regular.

- Ribbed collar.
- Large cobra artwork at front with Can-Am mention.

**Can-Am DNA T-Shirt**

288173 • S, M, L, XL, 2XL, 3XL

Army Green (77), Black (90)



Men's Can-Am graphic T-shirt, perfect for everyday wear.  
 • 60% cotton, 40% polyester.  
 • Fit: Regular.

- Ribbed collar.
- Large Can-Am graphic at front.

**Can-Am Bones T-Shirt**

288182 • S, M, L, XL, 2XL, 3XL

Black (90), Heather Grey (27)



Men's casual graphic T-shirt with skeletal vehicle artwork printed at back.  
 • 60% cotton, 40% polyester.  
 • Heather Grey (27): 97% cotton, 3% polyester.  
 • Fit: Regular.

- Ribbed collar.
- Small Can-Am logo at left chest and large artwork at back.

**Can-Am Badges Long Sleeve T-Shirt**

288166 • S, M, L, XL, 2XL, 3XL

Black (90)



Men's long-sleeve T-shirt with printed Can-Am badges.  
 • 60% cotton, 40% polyester.  
 • Fit: Regular.

- Ribbed collar.
- Printed Can-Am badges on the sleeve and left chest.

**NEW Can-Am All-Star T-Shirt**

288149 • XS, S, M, L, XL, 2XL

Black (90), Wine (32)



Women's Casual Graphic T-Shirt.  
 • Solid color: 60% cotton, 40% polyester.  
 • Heather color: 97% cotton, 3% polyester.  
 • Fit: Slim.  
 • Rib-knit crew neck.

**NEW Can-Am Heritage T-Shirt**

288285 • XS, S, M, L, XL, 2XL

Black (90), Pink (36)



Women's Casual Graphic T-Shirt with Heritage artwork at back.  
 • Content: 60% cotton, 40% polyester.  
 • Fit: Slim.  
 • Ribbed collar.  
 • Small Can-Am logo at left chest and artwork at back.  
 • Small embroidered label at front.

**NEW** Can-Am '73 T-Shirt

288286 • XS, S, M, L, XL, 2XL

Black (90)



Women's Casual Graphic T-Shirt with large 73 Can-Am logo at front.

- Content: 60% cotton, 40% polyester.
- Fit: Slim.
- Ribbed collar.
- Small embroidered label at front.

**Can-Am Loyal T-Shirt**

288150 • XS, S, M, L, XL, 2XL

Black (90), White (01)



Women's casual graphic T-shirt with Can-Am printed quote at back.

- 60% cotton, 40% polyester.
- Fit: Slim.

- Ribbed collar.
- Small Can-Am logo at left chest and artwork at back.

**NEW** Can-Am Mav Bones Flat Cap

288176 • One size

Army Green (77)



Unisex Mav Bones Cap with flat brim.

- 100% cotton.
- Structured 6-panel cap.
- Snapback closure at back.
- Inside Can-Am branded tape.
- Patch at front.

**NEW** Can-Am King Cobra Curved Cap

288177 • One size

Black (90), Sand (03)



Unisex King Cobra curved-brim cap.

- 100% cotton.
- 6-panel cap.
- Soft plastisol printed patch.
- Can-Am branded tape inside and flag label at back.
- Snapback closure at back.

**NEW** Can-Am Heritage Curved Cap

288264 • One size

Black (90)



Classic Curved Cap with a Can-Am patch at front.

- 100% cotton.
- 6-panel cap.
- Heritage patch embroidered at front.
- Can-Am branded tape inside.
- Snapback closure at back.

**Can-Am Laser Cut Curved Cap**

288144 • One size

Black (90), Sand (03)



Unisex breathable cap with laser-cut mesh.

- 100% polyester.
- UPF 30 sun protection.
- Quick-dry.
- Silicon patch at front.
- Snapback closure at back.

UNISEX

**Can-Am Loyal Flat Mesh Cap****288143** • One size

Army Green (77), Black (90)



Unisex mesh cap with flat brim.

- Content: 100% cotton.
- Mesh: 100% polyester.
- Structured 5-panel cap.
- Snapback closure at back.
- Patch at center front.
- Small Can-Am label at back.

# SIGNATURE COLLECTION

MEN'S

**NEW 1973 Signature T-Shirt****288278** • S, M, L, XL, 2XL, 3XL

Black (90), Red (30), White (01)



Men's Casual Signature T-Shirt with Can-Am logo and 1973.

- 60% cotton, 40% polyester.
- Fit: Regular.
- Rib at cuffs and hem.
- Can-Am logo at center front and small 1973 printed on the right sleeve.
- Small embroidered label at front

**1973 Signature LS T-Shirt****288355** • S, M, L, XL, 2XL, 3XL

Black (90)



Men's Casual Signature Long-Sleeve T-Shirt with Can-Am logo and 1973.

- 60% cotton, 40% polyester.
- Fit: Regular.
- Rib at cuffs and hem.
- Can-Am logo at center front and small 1973 printed on the right sleeve.
- Small embroidered label at front.

**Can-Am Emblem T-Shirt****288148** • S, M, L, XL, 2XL, 3XL

Black (90), Heather Grey (27), Sand (03)



Men's Signature T-shirt with Can-Am logo and emblematic lines at front.

- 60% cotton, 40% polyester.
- Heather Grey (27): 97% cotton, 3% polyester.
- Fit: Regular.
- Ribbed collar.

**NEW 1973 Signature Crewneck Sweatshirt****288353** • S, M, L, XL, 2XL, 3XL

Black (90)



Men's Signature Crewneck Sweatshirt with Can-Am logo and 1973.

- 60% cotton, 40% polyester.
- Fit: Regular.
- Rib at cuffs and hem.
- Can-Am logo at center front and small 1973 printed at back neck.
- Small embroidered label at front.

**Can-Am Emblem Crewneck****288241** · S, M, L, XL, 2XL, 3XL

Black (90), Heather Grey (27)



Men's Signature crewneck sweatshirt with Can-Am logo and emblematic lines at front.

- 60% cotton, 40% polyester.
- Fit: Regular.
- Rib at cuffs and hem.

**NEW 1973 Signature Pullover Hoodie****288354** · S, M, L, XL, 2XL, 3XL

Black (90), Heather Grey (27)



Men's Signature Pullover Hoodie with Can-Am logo and 1973.

- 60% cotton, 40% polyester.
- Fit: Regular.
- Rib at cuffs and hem.
- Kangaroo pocket.
- Can-Am logo at center front and 1973 printed across the center panel of the hood.
- Small embroidered label on the kangaroo pocket.

**Can-Am Emblem Pullover Hoodie****288242** · S, M, L, XL, 2XL, 3XL

Black (90), Sand (03)



Men's Signature pullover hoodie with Can-Am logo and emblematic lines at front.

- 60% cotton, 40% polyester.
- Fit: Regular.
- Rib at cuffs and hem.
- Kangaroo pocket.

**Can-Am Emblem Cap****288142** · One size

Army Green (77), Black (90), Burgundy (35), Heather Grey (27)



Signature cap with Can-Am logo and emblematic lines at front.

- 100% cotton.
- 6-panel cap.
- Embroidered Can-Am logo on the front.

- Can-Am branded tape inside and flag label at back.
- Snapback closure at back.

**NEW 1973 Signature T-Shirt**

**288284** • XS, S, M, L, XL, 2XL

Black (90), Pink (36)



- Women's Casual Signature T-Shirt with Can-Am logo and 1973.
- Content: 60% cotton, 40% polyester.
  - Fit: Slim.
  - Rib at cuffs and hem.
  - Can-Am logo at center front and small 1973 printed on the right sleeve.
  - Small embroidered label at front.

**Can-Am Emblem T-Shirt**

**288187** • XS, S, M, L, XL, 2XL

Black (90), Sand (03)



- Women's Signature T-shirt with Can-Am logo and emblematic lines at front.
- 60% cotton, 40% polyester.
  - Fit: Slim.
  - Ribbed collar.

**NEW 1973 Signature Crewneck Sweatshirt**

**288352** • XS, S, M, L, XL

Black (90)



- Women's Signature Crewneck Sweatshirt with Can-Am logo and 1973.
- Content: 60% cotton, 40% polyester.
  - Fit: Slim.
  - Rib at cuffs and hem.
  - Can-Am logo at center front and small 1973 printed at back neck.
  - Small embroidered label at front.

**Can-Am Emblem Crewneck**

**288243** • XS, S, M, L, XL, 2XL

Black (90), Wine (32)



- Women's Signature crewneck sweatshirt with Can-Am logo and emblematic lines at front.
- 60% cotton, 40% polyester.
  - Fit: Slim.
  - Rib at cuffs and hem.

**NEW 1973 Signature Pullover Hoodie**

**288351** • XS, S, M, L, XL

Black (90), Wine (32)



- Comfortable Pullover Hoodie sweatshirt with Can-Am logo on the front.
- Content: 60% cotton, 40% polyester.
  - Fit: Slim.
  - Rib at cuffs and hem.
  - Kangaroo pocket.
  - Can-Am logo at center front and 1973 printed across the center panel of the hood.
  - Small embroidered label on the kangaroo pocket.

**Can-Am Emblem Pullover Hoodie**

**288244** • XS, S, M, L, XL, 2XL

Army Green (77), Black (90)



- Women's Signature pullover hoodie with Can-Am logo and emblematic lines at front.
- 60% cotton, 40% polyester.
  - Fit: Slim.
  - Rib at cuffs and hem.
  - Kangaroo pocket.

**NEW Can-Am 1973 Signature Cap****288112** · One size

Army Green (77), Black (90), Grey (09), Red (30), Wine (32)



Signature curved cap.

- 100% cotton.
- 6-panel cap.
- Embroidery Can-Am patch at front.
- Snapback closure at back with small Can-Am label.

**Can-Am Reversible Camo Beanie****288160** · One size

Army Green (77), Black (90), Grey (09)



Two-in-one reversible beanie with our new hexagon camo knit pattern.

- 95% acrylic, 4% nylon, 1% spandex.
- Hypoallergenic.
- Small folded Can-Am label at front.
- Embroidered Can-Am logo at front.

**NEW 1973 Signature Bandana****288281** · One size

Black (90), Wine (32)



Our bandana is a cheerful accessory, perfect for our bold riders! It will become your new staple piece when riding.

- 100% cotton.
- Dimensions: 24" x 24".
- Can be worn many different ways.
- Checkered print, Can-Am logo and 1973 printed.

# UV PROTECTION AND PLAY

Introducing our UV Protection and Play collection.

Your ultimate gear for all-day comfort, designed to protect against the sun. Featuring windproof jerseys, lightweight long-sleeve shirts, comfortable hoodies and more! All with new colors and graphics!



Men's UV Protection  
Long-Sleeve T-Shirt  
**BLACK**

288161\_90

Women's  
Can-Am  
Lightweight  
Tank Top

**WINE**

288167\_32

Women's UV  
Protection  
Long-Sleeve T-Shirt  
**BLACK**

288169\_90

Men's UV Protection  
Long-Sleeve Hoodie  
**ARMY GREEN**

288168\_77

# UV PROTECTION AND PLAY

MEN'S

## UV Protection Long-Sleeve T-Shirt

288161 • S, M, L, XL, 2XL

Black (90), Charcoal Grey (07)



Men's lightweight UV protection long-sleeve shirt, meant to protect your skin all day long.

- 92% polyester, 8% spandex.
- Fit: Regular.
- UPF 50 sun protection.

- Quick-dry fabric that helps distribute your body heat and rapidly cools through regulated evaporation.
- Can-Am artwork at back and Can-Am logo at right sleeve.

## UV Protection Long-Sleeve Hoodie

288168 • S, M, L, XL, 2XL

Army Green (77), Black (90)



Men's UV protection long-sleeve hooded shirt with built-in gaiter to protect you from the dust and sun.

- 92% polyester, 8% spandex.
- Fit: Regular.
- 175 gsm.

- UV protection – 50 UPF.
- Quick-dry.
- Built-in gaiter mask.
- Can-Am logo on the right sleeve and artwork at left chest.

## Can-Am DWR Hoodie

288158 • S, M, L, XL, 2XL, 3XL

Army Green (77), Black with Graphics (94)



Versatile pullover hoodie with water-repellent finish that will allow you to wear it no matter the weather!

- 60% cotton, 40% polyester.
- Fit: Regular.
- Rib at cuffs and hem.

- Kangaroo pocket.
- New! Hexagon camo print.
- Can-Am label at front kangaroo pocket.

WOMEN'S

## Can-Am Lightweight Tank Top

288167 • XS, S, M, L, XL, 2XL

Charcoal Grey (07), Wine (32)



Women's lightweight tank top, perfect for everyday wear.

- 88% nylon and 12% spandex.
- Fit: Regular.
- UPF 20 sun protection.

- Quick-dry fabric that helps distribute your body heat and rapidly cools through regulated evaporation.
- Large vertical Can-Am logo on the left side.

## UV Protection Long-Sleeve T-Shirt

288169 • XS, S, M, L, XL, 2XL

Black (90)



Women's lightweight UV protection long-sleeve shirt, meant to protect your skin all day long.

- 92% polyester, 8% spandex.
- Fit: Slim.
- UPF 50 sun protection.

- Quick-dry fabric that helps distribute your body heat and rapidly cools through regulated evaporation.
- Thumbhole opening at sleeve.
- Can-Am artwork at back.

UNISEX

## Can-Am Phantom Jersey

288270 • S, M, L, XL, 2XL, 3XL

Army Green (77), Burgundy (35), Charcoal Grey (07), Grey (09)



Our classic Can-Am jersey with a new look!

- 100% polyester.
- Fit: Relaxed.
- Quick-dry, moisture-wicking fabric for maximum comfort.
- Antibacterial treatment for anti-odor.

- Mesh fabric for extra ventilation at underarms.
- Hexagon camo print.
- Sublimated logos.

# PLAY AND LICENSING PRODUCTS

MISC

**NEW** 1:12 Maverick X3 X RS Turbo RR Premium Replica



**B10787** • One size

Black (90)

- Product dimensions: 286 x 155 x 145 mm
- Diecast metal and plastic.
- Free-rolling wheels.
- Articulated steering.
- Functional suspensions.
- Openable doors.
- Interior cab details.
- Authentic exterior design.

**NEW** 1:12 X3 X RS Turbo RR Premium Replica with accessories



**B10788** • One size

Red (30)

- Product dimensions: 281 x 155 x 161 mm
- Diecast metal and plastic.
- Free-rolling wheels.
- Articulated steering.
- Functional suspensions.
- Openable doors.
- Interior cab details.
- Authentic exterior design.

**NEW** 1:12 Maverick X3 X RC Turbo RR Premium Replica



**B10789** • One size

Red (30)

- Product dimensions: 286 x 155 x 145 mm
- Diecast metal and plastic.
- Free-rolling wheels.
- Articulated steering.
- Functional suspensions.
- Openable doors.
- Interior cab details.
- Authentic exterior design.

**NEW** 1:32 Diecast Maverick Sport 24 pcs Case-Pack



**B10790** • One size

Mixed color (18)

- This Case-Pack includes:
- 12 x 1:32 Maverick Sport X rc (Red)
  - 12 x 1:32 Maverick Sport X xc (Silver)

**NEW** 1:32 Diecast Maverick Trail 24 pcs Case-Pack



**B10791** • One size

Mixed color (18)

- This Case-Pack includes:
- 12 x 1:32 Maverick Trail DPS (Black)
  - 12 x 1:32 Maverick Trail DPS (Blue)

**NEW** 1:32 Diecast Commander 24 pcs Case-Pack



**B10792** • One size

Mixed color (18)

- This Case-Pack Includes:
- 12 x 1:32 Commander XT-P (Orange).
  - 12 x 1:32 Commander XT (Black).

**NEW Diecast Defender 24 pcs Case-Pack****B10793** · One size

Mixed color (18)



This Case-Pack includes:

- 12 x 1:32 Defender XMR (Silver)
- 12 x 1:32 defender XT HD9 (Navy)

**1:32 Diecast Maverick Bundle****B10777** · One size

Mixed color (18)



Bundle includes:

- 10 x 1:32 Maverick X3 X RS Turbo RR (Black).
- 5 x 1:32 Maverick X3 X RS Turbo RR (Blue).
- 5 x 1:32 Maverick X3 X RS Turbo RR (Red).
- 2 x 1:32 Maverick X3 X RS Turbo RR Sand (Red).
- 2 x 1:32 Maverick X3 X RS Turbo RR Winter (Red).

**1:32 Diecast Outlander Bundle****B10778** · One size

Mixed color (18)



Bundle includes:

- 12 x 1:32 Outlander XT 1000R (Blue).
- 12 x 1:32 Outlander XT 1000R (Yellow).

**1:32 Diecast Renegade Bundle****B10779** · One size

Mixed color (18)



Bundle includes:

- 6 x 1:32 Renegade X xc (Sand).
- 6 x 1:32 Renegade X xc (Red).
- 6 x 1:32 Renegade X mr 1000R (Sand).
- 6 x 1:32 Renegade X mr 1000R (Gold).

# REPLACEMENT PARTS

**Helmet Service Pad****448695** · One size

Black (90)

- Part made to support a helmet while servicing it.

## VIBE

**Vibe Microphone****929132** · One size

Black (90)



- Fits Vibe Communication System by BRP.

**Vibe Speakers****929133** · One size

Black (90)

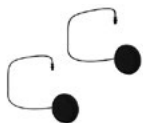

- Fits Vibe Communication System by BRP

# PYRA

MISC

<p><b>Pyra Headliner</b></p> 	<p><b>929060</b> • XS, S, M, L, XL, 2XL, 3XL</p>	<p>Charcoal Grey (07)</p>	<p>• Fits Pyra helmet family.</p>
<p><b>Pyra Cheek Pads</b></p> 	<p><b>929061</b> • XS, S, M, L, XL, 2XL, 3XL</p>	<p>Charcoal Grey (07)</p>	<p>• Fits Pyra helmet family.</p>
<p><b>Pyra Wind Deflector</b></p> 	<p><b>929062</b> • S (fits XS/S/M/L), L (fits XL/2XL/3XL)</p>	<p>Black (90)</p>	<p>• Fits Pyra helmet family.</p>
<p><b>Pyra Peak Pivots</b></p> 	<p><b>929073</b> • One size</p>	<p>Black (90)</p>	<p>• Fits Pyra helmet family. • Includes 2 pcs.</p>
<p><b>Pyra Fixed Peak Pivots</b></p> 	<p><b>929096</b> • One size</p>	<p>Black (90)</p>	<p>• Fits Pyra helmet family. • Includes 2 pcs.</p>
<p><b>Pyra Front Vent Grid</b></p> 	<p><b>929097</b> • S (fits XS/S/M/L), L (fits XL/2XL/3XL)</p>	<p>Black (90)</p>	<p>• Fits Pyra helmet family.</p>
<p><b>Can-Am Pyra Phantom Peak</b></p> 	<p><b>929163</b> • S (fits XS/S/M/L), L (fits XL/2XL/3XL)</p>	<p>Black (90), Grey (09)</p>	<p>• Fits Pyra helmet style 929159.</p>
<p><b>Pyra Fade Peak</b></p> 	<p><b>929091</b> • S (fits XS/S/M/L), L (fits XL/2XL/3XL)</p>	<p>Beige (02), Grey (09), Turquoise (Aqua) (76), White (01)</p>	<p>• Fits Pyra helmet family.</p>

**Can-Am Pyra Peak****929063** · S (fits XS/S/M/L),  
L (fits XL/2XL/3XL)Blue (80), Charcoal Grey (07),  
Red (30)

- Fits Pyra helmet family.

**Can-Am Pyra Dune Peak****929064** · S (fits XS/S/M/L),  
L (fits XL/2XL/3XL)Charcoal Grey (07), Grey (09),  
Red (30), Sand (03)

- Fits Pyra helmet family.

**EXOME****NEW Exome Headliner**

DOT ECE22.06

**929188** · XS, S, M, L, XL, 2XL,  
3XL

Black (90)



- Fits Can-Am Exome Modular Helmet (DOT/ECE) (929190) and Can-Am Exome Open Face helmet (DOT/ECE) (929185).

**Exome Single Lens Shield****929044** · One size

Clear (00)



- Fits Can-Am Exome Helmet (929040).
- Replacement Pinlock-ready face shield for Exome helmets.

**Exome Summer Chin Curtain****929046** · One size

Black (90)



- Fits Can-Am Exome Helmet (929040).

**Exome Peak Fasteners Kit****929047** · One size

Black (90)











- Fits Exome helmet family.

**Exome Summer Headliner****929049** · XS, S, M, L, XL, 2XL, 3XL

Charcoal Grey (07)



- Fits summer Exome helmet family.

<b>Exome Peak</b>		<b>929057</b> • One size	Black (90), Matte Black (93)	
		• Fits Exome helmet family.		
<b>Exome Summer Vents Kit</b>		<b>929065</b> • One size	Black (90)	
		• Fits Exome helmet family.		
<b>Exome Pinlock® Insert</b>		<b>929066</b> • One size	Clear (00)	
		• Fits Exome helmet family.		
<b>Exome Shield Mechanism</b>		<b>929067</b> • One size	Black (90)	
		• Fits Exome helmet family.		
<b>Exome Shield Sealing Gasket</b>		<b>929070</b> • One size	Black (90)	
		• Fits Exome helmet family.		
<b>Exome Summer Sun Shield</b>		<b>929072</b> • One size	Smoke (57), Clear (00)	
		• Fits Exome helmet family.		
<b>Exome Summer Chin Lock Covers</b>		<b>929075</b> • One size	Black (90)	
		• Fits Exome helmet family.		
<b>Exome Summer Cheek Pads</b>		<b>929092</b> • XS, S, M, L, XL, 2XL, 3XL	Charcoal Grey (07)	
		• Fits summer Exome helmet family.		

MISC

**Exome Open Face Peak****929145** - One size

Black (90)

- Fits Exome Open-Face helmet family.

**Exome Open Face Headliner**

DOT

**929147** - XS, S, M, L, XL, 2XL, 3XL

Charcoal Grey (07)

- Fits Exome Open-Face helmet family.
- DOT certified version only.

**Exome Open Face Cheek Pads****929148** - XS, S, M, L, XL, 2XL, 3XL

Black (90), Charcoal Grey (07)

- Fits summer Exome Open-Face helmet family.

**RETRO OPEN FACE**

MISC

**NEW Retro Open Face RPM Peak****929192** - One size

Black (90)

- Fits Retro Open Face helmets.

**NEW Retro Open Face Cheek Pads****929193** - S, M, L, XL, 2XL

Black (90)

- Fits Retro Open Face helmet.

**FLINT**

MISC

**Flint Goggles Tear-Offs****448759** - One size

Clear (00)

- Ready-to-use clear tear-off tabs.
- Pack of 10.

**Flint Goggles Nose Guard****448760** - One size

Black (90)

- Fits all Flint goggles:
  - Flint Dune.
  - Flint Fade.
  - Flint Phantom.



MISC

**Flint Goggles Clear Single UV Lens****448764** • One size

Clear (00)



- Fits all Flint goggles:
  - Flint Dune.
  - Flint Fade.
  - Flint Phantom.

**Flint Goggles Chrome Single UV Lens****448765** • One sizeBlue (80), Chrome (99), Red (30),  
Turquoise (Aqua) (76), Yellow (10)

- Fits all Flint goggles:
  - Flint Dune.
  - Flint Fade.
  - Flint Phantom.

**Flint Photochromatic RPM Single UV Lens****448784** • One size

Smoke (57)



- Fits Flint goggle family.

**TRENCH**

MISC

**Trench Goggles Nose Guard****448708** • One size

Black (90)



- Fits Trench goggles.

**Trench Goggles Single UV Lens****448697** • One size

Clear (00)



- Trench anti-scratch, anti-fog RPM lens.
- Clear.

**Trench OTG Goggles Single UV Lens****448793** • One size

Clear (00), Smoke 60% (21)



- Fits Trench OTG goggle family.
- Can-Am laser etching on lens.

**Trench Goggles Tear-Offs****448727** • One size

Clear (00)



- Compatible with the Can-Am Trench goggle.
- Pack of 10.

**Trench OTG Goggles Tear-Offs****448795** • One size

Clear (00)



- Fits Trench OTG goggle family.
- Pack of 10.





## BRP REIMAGINES THE WAY YOU ACCESS YOUR WORLD

Can-Am is one of many success stories from BRP, the global company behind some of the most daringly innovative products and experiences that move you. Because it's not about the destination, it's about the journey — yours.

Discover our brands:

**ski-doo** **LYNX** **SEA-DOO** **can-am** **ROTAX**

[www.brp.com](http://www.brp.com)





**CANAMOFFROAD.COM**

MY26 716001966

